

# B2N10H-Q20L60-2LU4-H1151/S1217 Inclinometer – With Increased Damping

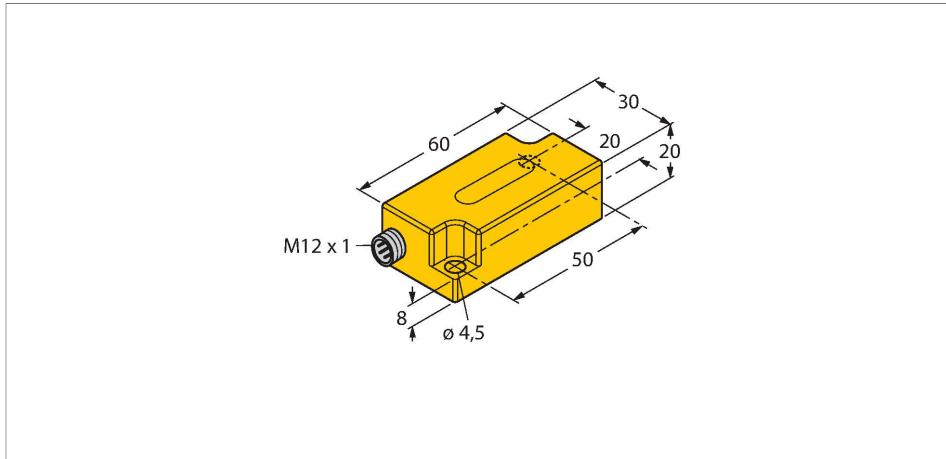

## Features

- Plastic, PC
- Response time 1 s
- Cutoff frequency 6 Hz
- Measuring range adjustable via teach adapter TX1-Q20L60
- Two analog outputs
- M12 x 1 male connector

## Wiring diagram

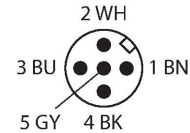
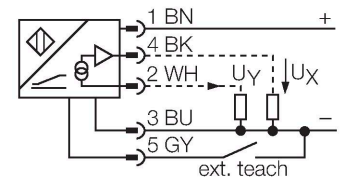

## Technical data

Type	B2N10H-Q20L60-2LU4-H1151/S1217
ID	1534115
Special version	S1217 corresponds to: Inclinometers: 1 s response time and 6 Hz low-pass filter and level 8
Measuring principle	Acceleration
<b>General data</b>	
Measuring range	-10...10 °
Number of measuring axes	2
Repeatability	≤ 0.2 % of measuring range  A - B
Linearity deviation	≤ 1 %
Temperature drift	≤ ± 0.05 % / K
Resolution	≤ 0.04 °
<b>Electrical data</b>	
Operating voltage	10...30 VDC
Isolation test voltage	≤ 0.5 kV
Short-circuit protection	yes
Wire breakage/Reverse polarity protection	no / yes
Surge protection	-48...48 VDC [U <sub>b,max.</sub> ]
Output function	5-pin, Analog output
Voltage output	0.5...4.5 V
Output impedance	99...105 Ω
Response time	1 s
Current consumption	50 mA

## Functional principle

Inclination is determined by a wear-free semiconducting sensor element.

## Technical data

Mechanical data	
Design	Rectangular, Q20L60
Dimensions	60 x 30 x 20 mm
Housing material	Plastic, PC
Electrical connection	Connector, M12 × 1
Environmental conditions	
Ambient temperature	-30...+70 °C
Vibration resistance	55 Hz (1 mm)
Shock resistance	30 g (11 ms)
Protection class	IP68 IP69K
MTTF	203 years acc. to SN 29500 (Ed. 99) 40 °C

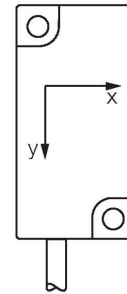
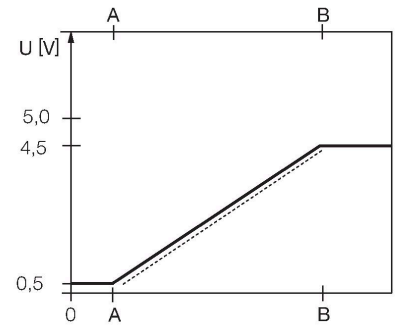
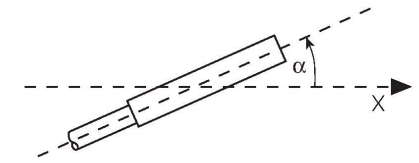

## Mounting instructions

### Mounting instructions/Description

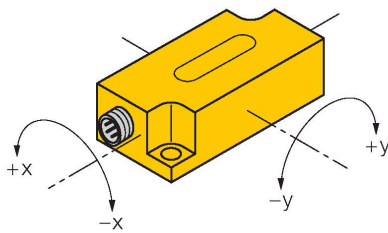

### Teaching

The zero point can be adjusted with teach adapter TX1-Q20L60. Teach-GND is pressed for approx. 1 s to do this. The outputs are switched to 5 V as confirmation. Teach-GND is pressed for 6 s to reset the axis zero points. The outputs are switched to 0 V as confirmation. Once the teach button is released, the sensor returns to normal operation.

## Accessories

### GUARD-Q20L60

A9684

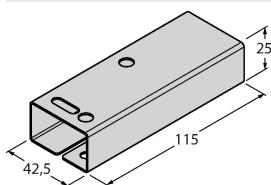

Protective housing for Q20L60 inclinometers for protecting against mechanical impact; material: Stainless steel