



# DLA SERIES + ACCESORIES

Stroke: 50 - 300mm  
150 - 1000N

Transmotec sell a broad range of linear actuators in standard and customized configurations. Transmotec is the ideal supplier source especially to instrument and apparatus builders. We keep a high number of actuators in stock for immediate delivery.

## Customizations include:

- ✓ Customized stroke length
- ✓ Customized clevis
- ✓ Customized cabling
- ✓ And more...

# DLA Series / 50 - 300mm / 150 - 1000N

**DRAWING**  
(mm)

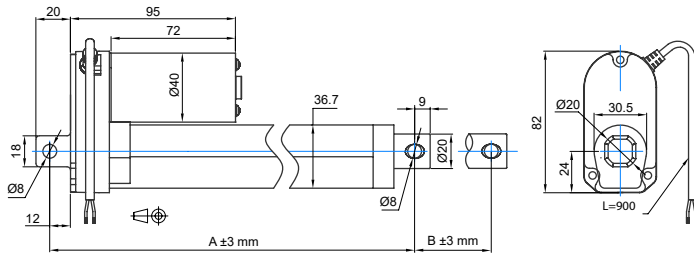

**PHOTO**



**MODEL NO. DESIGNATION**



Example: DLA-12-5-A-50-IP65

**ACTUATOR DATA**

Reduction	5	10	20	30	40
Voltage (VDC)	12/24	12/24	12/24	12/24	12/24
Current at nominal dynamic load (A)	2.0/1.0	2.4/1.2	2.6/1.3	2.9/1.5	2.8/1.4
Nominal dynamic load (N)	150	250	500	800	1000
Max. static load (N)	1500	1500	1500	1500	1500
Speed at nominal dynamic load (mm/s)	36.5	23.5	12.3	7.5	5.5

**ACTUATOR STROKE DATA**

Stroke length B (mm)	50	100	150	200	250	300
Retracted length A (mm)	158	209	260	311	362	413
Life time number single strokes	80.000	40.000	26.666	20.000	16.000	13.333
Weight (kg)	0.850	0.925	0.990	1.060	1.130	1.200

**ACTUATOR FEATURES AND STANDARD DATA**

	STANDARD	CUSTOMIZATION OPTIONS
Type	Electric linear actuator	
Motor type	Brush PM DC motor	
Cable	Flying wire 900 mm	Length, type and connector
Voltage	12 or 24 VDC	36 or 48 VDC
Screw type	ACME pitch 3 mm	
Noise level	< 70 dB (A)	Yes
Life time	4 million mm total stroke	
Limit switches	Integrated non adjustable	Stroke length
Direction movement	By reversing voltage polarity	Yes
Stroke tolerance	±3 mm	±2 mm
Duty cycle	25%	
Max. duty operational time	1 min. nominal dynamic load	
Protection class	IP65	
Insulation class	F	
Max. motor winding temp.	155 °C	
EMC	EN55014 IEC61000	
Gear box	Metal spur gears	
Motor pinion gear	Plastic	Metal
Gear box material	Zinc alloy	
Rod and house material	Aluminum STKM11A	
Feedback options	Potentiometer or hall sensor	
Operating and storage temperature	-26°C~+65°C	
Manufacturing quality standards	ISO 9001:2008	
RoHS compliance	Yes	
CE label	Yes	

**Motor wiring**

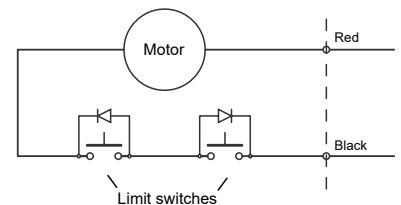

	Red	Black
Extend	+	-
Retract	-	+

# DLA Series / 50 - 300mm / 150 - 1000N / potentiometer (POT)

**DRAWING**  
(mm)

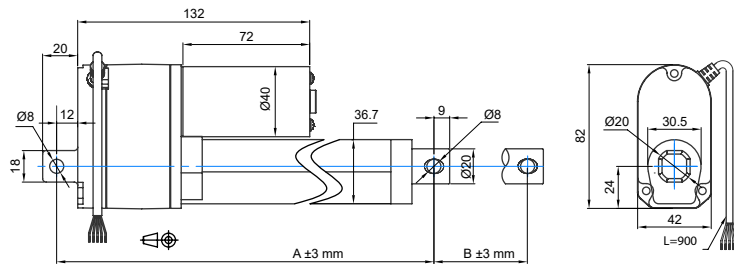

**PHOTO**



**MODEL NO. DESIGNATION**



Example: DLA-12-5-A-50-POT-IP65

**ACTUATOR DATA**

	5	10	20	30	40
Reduction	5	10	20	30	40
Voltage (VDC)	12/24	12/24	12/24	12/24	12/24
Current at nominal dynamic load (A)	2.0/1.0	2.4/1.2	2.6/1.3	2.9/1.5	2.8/1.4
Nominal dynamic load (N)	150	250	500	800	1000
Max. static load (N)	1500	1500	1500	1500	1500
Speed at nominal dynamic load (mm/s)	36.5	23.5	12.3	7.5	5.5

**ACTUATOR STROKE DATA**

	50	100	150	200	250	300
Stroke length B (mm)	50	100	150	200	250	300
Retracted length A (mm)	195	246	297	348	399	450
Resistance (kΩ)	0.3-9.3	0.3-9.7	0.3-8.6	0.3-9.6	0.3-9.3	0.3-9.3
Feedback (Ω/mm)	180	95	55	46	36	30
Life time number single strokes	80.000	40.000	26.666	20.000	16.000	13.333
Weight (kg)	1.110	1.175	1.250	1.315	1.385	1.455

**ACTUATOR FEATURES AND STANDARD DATA**

	STANDARD	CUSTOMIZATION OPTIONS
Type	Electric linear actuator	
Motor type	Brush PM DC motor	
Cable	Flying wire 900 mm	Length, type and connector
Voltage	12 or 24 VDC	36 or 48 VDC
Screw type	ACME pitch 3 mm	
Noise level	< 70 dB (A)	Yes
Life time	4 million mm total stroke	
Limit switches	Integrated non adjustable	Stroke length
Direction movement	By reversing voltage polarity	Yes
Stroke tolerance	±3 mm	±2 mm
Duty cycle	25%	
Max. duty operational time	1 min. nominal dynamic load	
Protection class	IP65	
Insulation class	F	
Max. motor winding temp.	155 °C	
EMC	EN55014 IEC61000	
Gear box	Metal spur gears	
Motor pinion gear	Plastic	Metal
Gear box material	Zinc alloy	
Rod and house material	Aluminum STKM11A	
Feedback	Potentiometer	
Operating and storage temperature	-26°C~+65°C	
Manufacturing quality standards	ISO 9001:2008	
RoHS compliance	Yes	
CE label	Yes	

**POTENTIOMETER FEATURES AND DATA**

Type	Wire wound
Resistance	0.3 - 9.7 kΩ
Resolution	0.025%
Resistance tolerance	±5%
Linearity	±0.25%
Cable	3+2 wires flying wire

Potentiometer wiring

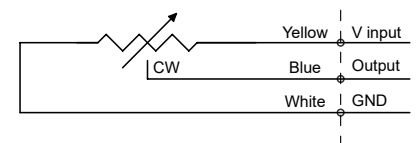

Motor wiring

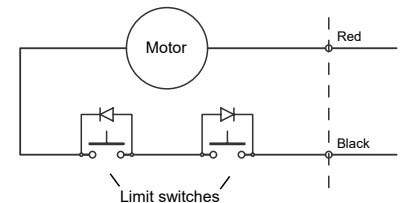

	Red	Black
Extend	+	-
Retract	-	+

# DLA Series / 50 - 300mm / 150 - 1000N / hall sensor (HS2)

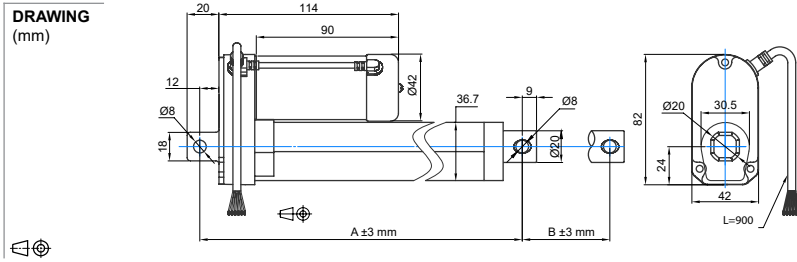

## MODEL NO. DESIGNATION

DLA - VOLTAGE - REDUCTION - A - STROKE - FEEDBACK - IP65 Example: DLA-12-5-A-50-HS2-IP65

## ACTUATOR STROKE DATA

Reduction	5	10	20	30	40
Voltage (VDC)	12/24	12/24	12/24	12/24	12/24
Current at nominal dynamic load (A)	2.0/1.0	2.4/1.2	2.6/1.3	2.9/1.5	2.8/1.4
Nominal dynamic load (N)	150	250	500	800	1000
Max. static load (N)	1500	1500	1500	1500	1500
Speed at nominal dynamic load (mm/s)	36.5	23.5	12.3	7.5	5.5
Number of encoder channels	2	2	2	2	2
Hall sensor channel counts per mm	4.6	7.2	13.8	21.2	28.6

## ACTUATOR DATA

	50	100	150	200	250	300
Stroke length B (mm)	50	100	150	200	250	300
Retracted length A (mm)	158	209	260	311	362	413
Life time number single strokes	80.000	40.000	26.666	20.000	16.000	13.333
Weight (kg)	0.850	0.925	0.990	1.060	1.130	1.200

## HALL SENSOR FEATURES AND DATA

CHARACTERISTIC	VALUE
Supply voltage, Vcc	3.5V to 20V
Supply Current, Icc	Vcc ≤ 10 mA
Output current, Ic	≤ 25 mA
Output saturation voltage, Vcc=14V	≤ 700mV
Output leakage current, Icox	Vcc= ≤ 10 µA
Output rise and fall time, tr/ tf	≤ 1,5 µs

## ACTUATOR FEATURES AND STANDARD DATA

	STANDARD	CUSTOMIZATION OPTIONS
Type	Electric linear actuator	
Motor type	Brush PM DC motor	
Cable	Flying wire 900 mm	Length, type and connector
Voltage	12 or 24 VDC	36 or 48 VDC
Screw type	ACME pitch 3 mm	
Noise level	< 70 dB (A)	Yes
Life time	4 million mm total stroke	
Limit switches	Integrated non adjustable	Stroke length
Direction movement	By reversing voltage polarity	Yes
Stroke tolerance	±3 mm	±2 mm
Duty cycle	25%	
Max. duty operational time	1 min. nominal dynamic load	
Protection class	IP65	
Insulation class	F	
Max. motor winding temp.	155 °C	
EMC	EN55014 IEC61000	
Gear box	Metal spur gears	
Motor pinion gear	Plastic	Metal
Gear box material	Zinc alloy	
Rod and house material	Aluminum STKM11A	
Feedback	Hall sensor	
Operating and storage temperature	-26°C~+65°C	
Manufacturing quality standards	ISO 9001:2008	
RoHS compliance	Yes	
CE label	Yes	

## Hall sensor output circuit Open collector output

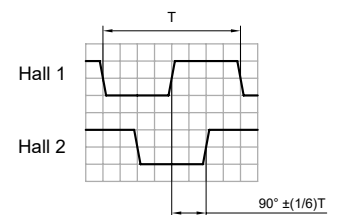
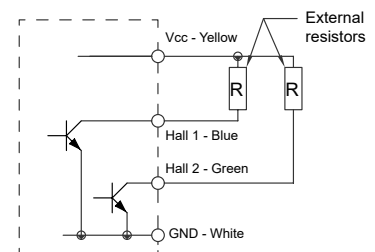

## Motor wiring

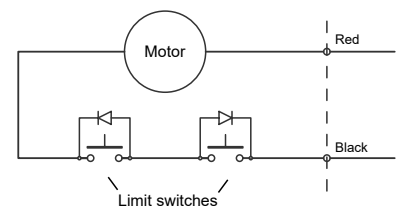

## DLA Series / control system

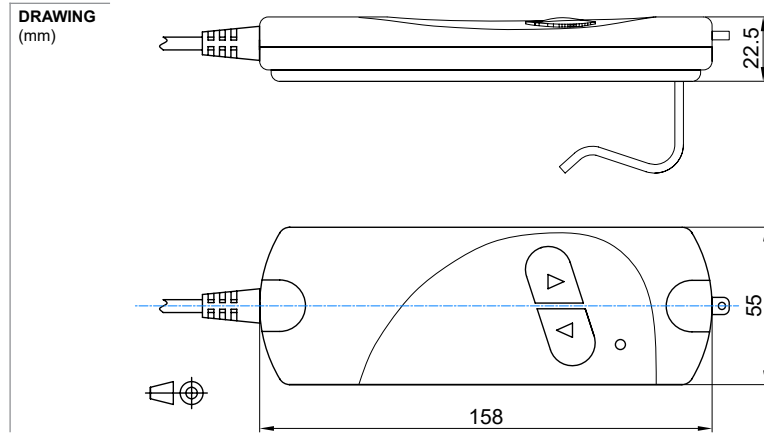

CONTROL SYSTEM DATA				
Input voltage (VAC)	110/60Hz	110/60Hz	230/50Hz	230/50Hz
Output voltage (VDC)	12	24	12	24
Output current limit (A)	6	3	6	3
Weight DDL transformer (g)	1290	1290	1290	1290
Weight HDL hand control (g)	180	180	180	180

CONTROL SYSTEM FEATURES AND DATA		
	STANDARD	CUSTOMIZATION OPTIONS
Type	AC/DC transformer	
Cable HDL	3000 mm	Yes
Cable DDL	1000 mm	Yes
Battery backup	2 x 9 volt batteries	
Integrated voltage polarity switch	Yes	
Current limit	Yes	
Actuator connector	DIN 2 poles	
Hand control connector	DIN 4 poles	
CE label	Yes	
UL approval	Yes for 110 VAC / 24 VDC	Yes

