

**KNIPPER & Co. GmbH**  
Am Halberg 10  
66121 Saarbruecken  
Phone: +49 681 665090  
mail: [perma@knipper.de](mailto:perma@knipper.de)  
[www.permashop.de](http://www.permashop.de)



**KNIPPER & Co. GmbH**  
Am Halberg 10  
66121 Saarbruecken  
Phone: +49 681 665090  
mail: [perma@knipper.de](mailto:perma@knipper.de)  
[www.permashop.de](http://www.permashop.de)





















28/09/2016 · A01 · Art. No. 108318

The Expert in Lubrication Solutions

[www.permashop.de](http://www.permashop.de)





I	 	1 - 2
II	 	3 - 6
III	 	7 - 8
IV	 	9
V	 ON	10
VI	     	11
VII	 	12
VIII	  OK	13
IX	 	14 - 15



	Betriebsanleitung	de	17 - 18
	Ръководство за експлоатация	bg	17 - 18
	Návod k obsluze	cs	19 - 20
	Brugsanvisning	da	19 - 20
	Εγχειρίδιο λειτουργίας	el	21 - 22
	Operating Instructions	en	21 - 22
	Manual de instrucciones	es	23 - 24
	Käyttöohje	fi	23 - 24
	Guide d'utilisation	fr	25 - 26
	Üzemeltetési utasítás	hu	25 - 26
	Istruzioni per l'uso	it	27 - 28
	取扱説明書	ja	27 - 28
	Gebruiksaanwijzing	nl	29 - 30
	Bruksanvisning	no	29 - 30
	Instrukcja obsługi	pl	31 - 32
	Manual de instruções	pt	31 - 32
	Manual de exploatare	ro	33 - 34
	Руководство по эксплуатации	ru	33 - 34
	Návod na obsluhu	sk	35 - 36
	Navodila za uporabo	sl	35 - 36
	Driftsanvisningar	sv	37 - 38
	Kullanım kılavuzu	tr	37 - 38
	操作指南	zh	39 - 40

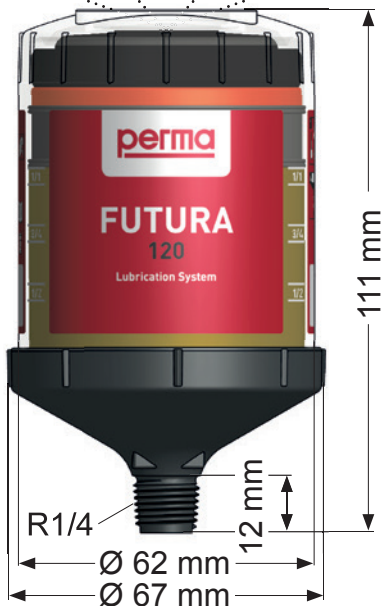
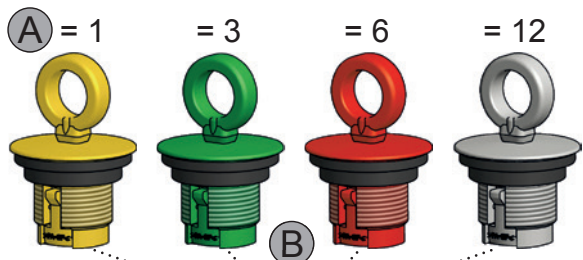

		120 cm <sup>3</sup>
	135 g	
	max. 4 bar / 58 psi	
	0 °C / +32 °F to +40 °C / +104 °F	
	FU – JJWW (yyww) – #####	
	+20 °C / +68 °F	
	max. 1 J (y)	

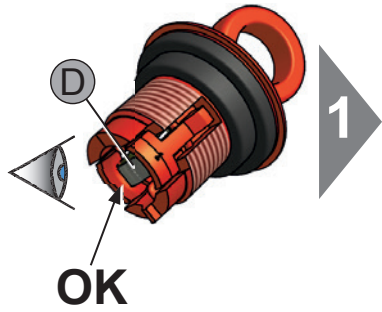

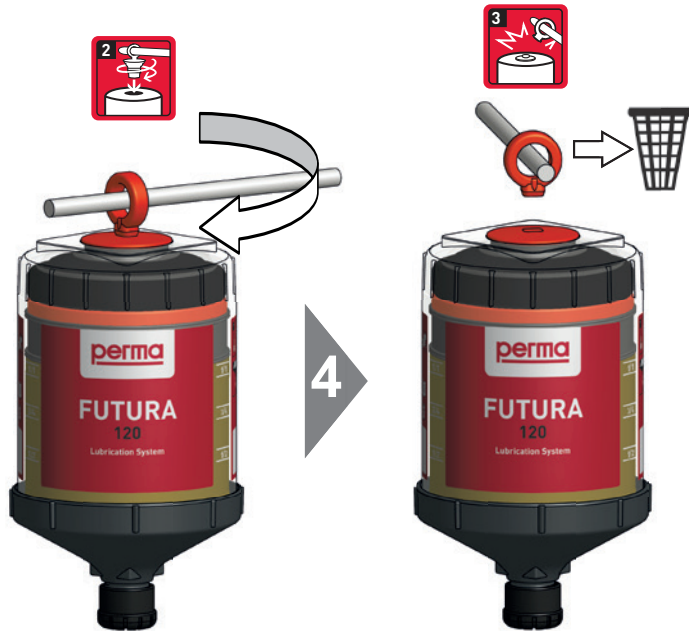

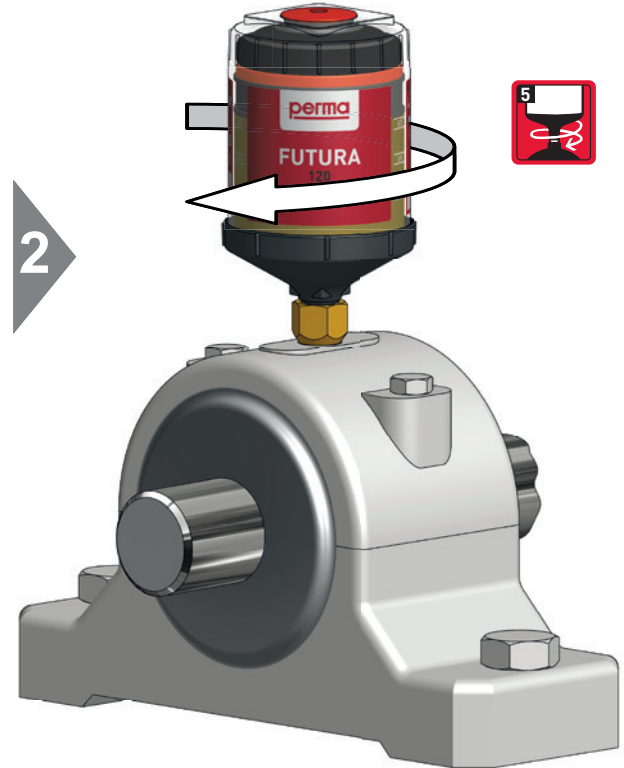
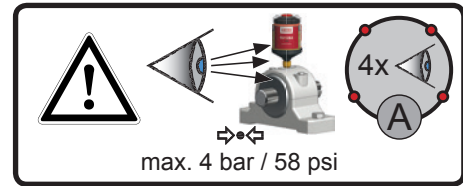
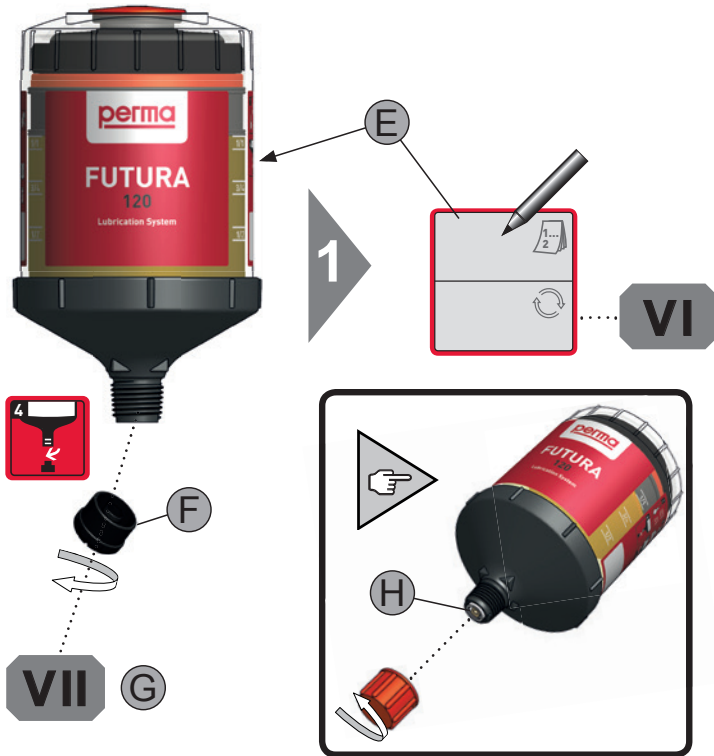





# IV

# V

				
0 °C/32 °F	4	8	15	> 18
+10 °C/50 °F	2	5	8	18
+20 °C/68 °F	1	3	6	12
+30 °C/86 °F	0,8	2	3	6
+40 °C/104 °F	0,6	1	2	3

(A)

**I** ≈ 24 h (⇄ 0 bar / 0 psi)

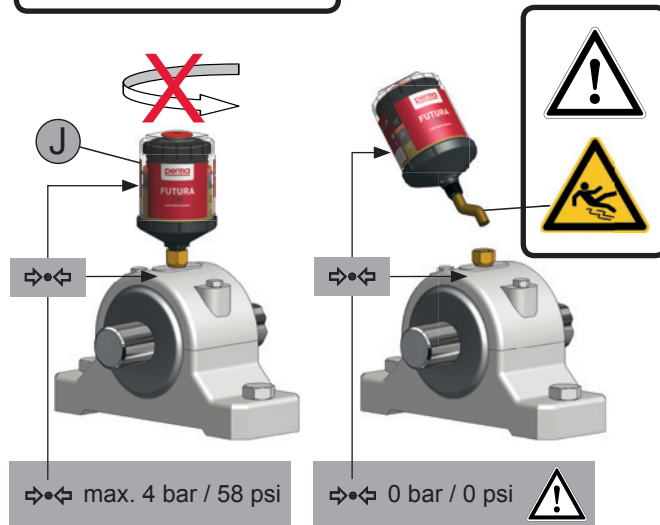
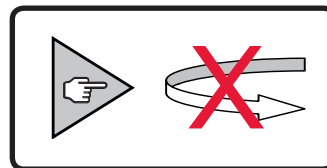
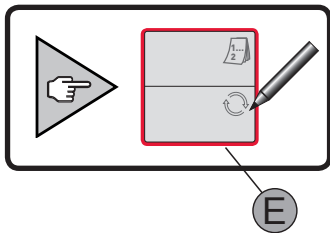

# VI

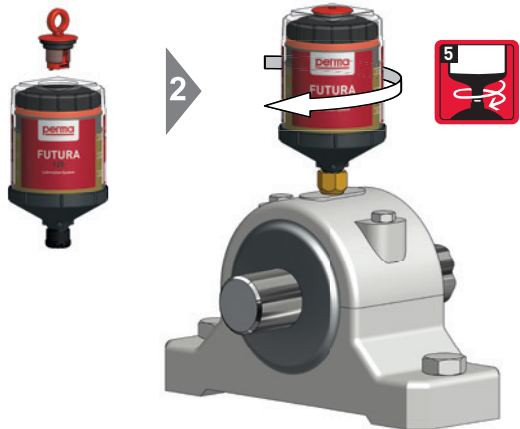
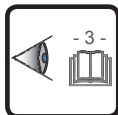
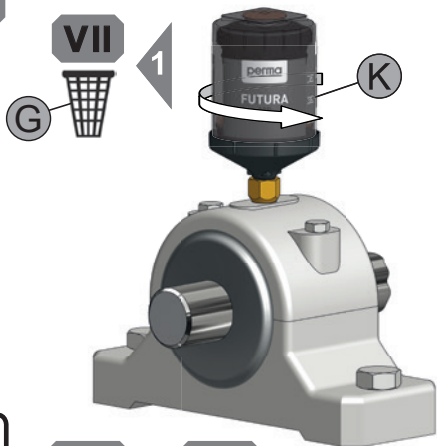



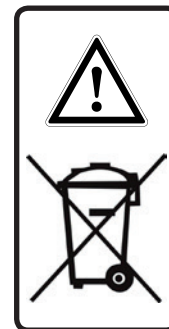



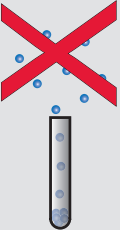

# VII

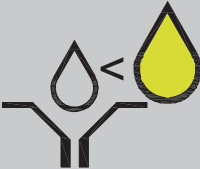

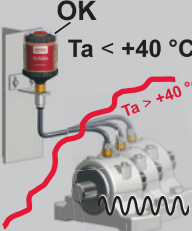



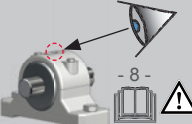





**VIII**  = 

(M)	(N)	(O)
		
	<p> <math>T_a &gt; +40\text{ }^\circ\text{C}</math></p> 	<p>OK <math>T_a &lt; +40\text{ }^\circ\text{C}</math></p> 
	<p> <math>T_a &lt; 0\text{ }^\circ\text{C}</math></p> <p> <math>&gt; 4\text{ bar}</math> <math>58\text{ psi}</math></p>	<p><b>IV</b></p> 

**IX**          

The enclosure is constructed from plastic. To prevent the risk of electrostatic sparking the plastic surface should only be cleaned with a damp cloth.

  I M2 c X 16-146-00  
II 2G c IIC T6 X FU-E2.0  
II 2D c T80°C X

  $0\text{ }^\circ\text{C} \leq T_a \leq +40\text{ }^\circ\text{C}$



EU-Konformitätserklärung nach Richtlinie 2014/34/UE	EU Declaration of Conformity according to Directive 2014/34/UE	Déclaration UE de conformité selon la directive 2014/34/UE	Declaración UE de conformidad según la directiva 2014/34/UE	Dichiarazione di conformità UE secondo la direttiva 2014/34/UE

**perma-tec GmbH & Co. KG**  
**Hammelburger Straße 21**  
**97717 EUERDORF / GERMANY**



Der Hersteller erklärt hiermit, dass das bezeichnete Produkt in den gelieferten Ausführungen den Bestimmungen der oben gekennzeichneten Richtlinien - einschließlich derer zum Zeitpunkt der Erklärung geltenden Änderungen - entspricht.	The manufacturer hereby declares that the product as described in the given statement conforms to the regulations appertaining to the directives referred to above, including any amendments thereto which are in force at the time of the declaration.	Le fabricant déclare par la présente que le produit désigné dans sa version livrée est conforme aux dispositions des directives citées ci-dessus - ainsi qu'aux modifications en vigueur au moment de la certification.	Por la presente el fabricante declara, que todas las versiones disponibles de este producto se ajustan a las directivas arriba indicadas, incluyendo los cambios que se produzcan al tiempo de emitir esta declaración.	Il produttore con la presente dichiara che il prodotto designato nei modelli consegnati è conforme alle disposizioni delle norme sopra riportate, incluse le variazioni valide al momento della dichiarazione.
---	---	---	---	--

Produktbezeichnung:	Product description:	Désignation:	Tipo de producto:	Descrizione del prodotto:
Automatisches Schmieresystem	Automatic lubrication system	Système de lubrification automatique	Sistema de lubricación automático	Sistema di lubrificazione automatica
Produktname:	Product name:	Nom du produit:	Denominación producto:	Nome del prodotto:

**FUTURA**

Type:	Type:	Type:	Type:	Type:
-------	-------	-------	-------	-------

120

Produktidentifikationsnummer:	Product identification number:	Numéro d'identification produit:	Número de identificación del producto:	Codice identificativo del prodotto:
-------------------------------	--------------------------------	----------------------------------	--	-------------------------------------

**FU-E2.0**

Folgende harmonisierte Normen wurden angewandt:	The following harmonised standards were applied:	Les normes associées suivantes ont été utilisées:	Se han aplicado las siguientes normas de armonización:	Sono state recepite le seguenti norme di standardizzazione:
---	--	---	--	---

EN 1127-1:2011, EN 1127-2:2014, EN 13463-1:2009, EN 13463-5:2011

Ex-Kennzeichnung:	Ex-Marking:	Classification Ex:	Ex-Identificación:	Marcatura Ex:
-------------------	-------------	--------------------	--------------------	---------------



I M2 c X II 2G c IIC T6 X II 2D c T80°C X 0 °C ≤ Ta ≤ +40 °C

16-146-00

Walter Graf, Managing Director

Egon Eisenbacher, Technical Management

Euerdorf, 28 September 2016



- 17 - - 18 -

Deutsch

Български

- 19 - - 20 -

Česky

Dansk

- 21 - - 22 -

Ελληνικά

English

- 23 - - 24 -

Español

Suomi

- 25 - - 26 -

Français

Magyar

- 27 - - 28 -

Italiano

日本語

- 29 - - 30 -

Nederlands

Norsk

- 31 - - 32 -

Polski

Português

- 33 - - 34 -

Română

Русский

- 35 - - 36 -

Slovensky

Slovenščina

- 37 - - 38 -

Svenska

Türkçe

- 39 - - 40 -

中文



de

Die Anleitung dient zum sicheren Arbeiten an und mit dem automatischen Schmieresystem, das Wälz- und Gleitlager, Ketten, Führungen, offene Getriebe etc. schmiert.



Das Schmieresystem ist nur einmal zu verwenden und darf nicht geöffnet oder zerlegt werden.

Kontakt mit Augen, Haut und Kleidung durch Öl/Fett und Verschlucken von Öl/Fett vermeiden.

Öl/Fett nicht ins Erdreich oder in die Kanalisation gelangen lassen.

Sicherheitsdatenblätter der Öle und Fette beachten.



Schützen Sie die Umwelt, indem Sie wertvolle Rohstoffe der Wiederverwertung zuführen. Beachten Sie die jeweiligen Entsorgungsrichtlinien Ihres Landes.



Schmierstoffdatenblätter können über unsere Homepage oder vom lokalen Händler bezogen werden.

Es wird keine Haftung für Schäden und Betriebsstörungen übernommen, die durch sachwidrige Verwendung und durch unsachgemäßes Arbeiten an und mit dem Schmieresystem entstehen.

bg

Инструкцията служи за безопасна работа с автоматичната смазочна система за смазване на сачмени и плъзгащи се лагери, вериги, водачи, отворени предавки и др.



Смазочната система е за еднократна употреба и не трябва да се отваря или да се разглобява.

Не допускайте контакт на очите, кожата и облеклото с масло/грес, както и поглъщане на масло/грес.

Не допускайте масло/грес да попадне в земята или в канализацията.

Съобразявайте се с листовките за безопасност на маслата и гресите.



Пазете околната среда, като рециклирате ценните суровини за повторна употреба. Съблюдавайте наредбите за отстраняване на отпадъци във Вашата страна.



Листовките за безопасност на смазочните материали могат да се изтеглят от нашата интернет страница или да се получат от местните търговци.

Не поемаме отговорност за щети и производствени неизправности, възникнали в резултат от неправилна употреба на смазочните материали или от неправилна работа със смазочната система.

- A Spendezeit in Monaten
- B Aktivierungsschraube
- C Lagerungsbedingungen
- D Gaserzeuger (Metalltablette)
- E Installations-/Wechseldatum
- F Verschlussstopfen
- G Fetthaltiger Abfall
- H Öl befüllt
- I Ölrückhalteventil
- J Anlaufzeit
- K In Betrieb
- L Leer
- M Korrekte Schmiermenge
- N Fehler
- O Ursache
- P Abhilfe
- Q Erdung mit Halteschelle

- I Eigenschaften
- II Aktivierung
- III Installation
- IV Spendezeiten
- V Wähdung der Spendezeit
- VI Wechsel
- VII Entsorgung
- VIII Fehlerbehebung
- IX Kennzeichnung



- A Време на подаване в месеци
- B Винт за активиране
- C Услови на съхранение
- D Газгенератор (метална таблетка)
- E Дата на инсталиране/смяна
- F Запушалка
- G Отпадъци, съдържащи грес
- H Напълнено масло
- I Спирателен вентил за масло
- J Време на стартиране
- K Работи
- L Празно
- M Правилно количество смазка
- N Грешка
- O Причина
- P Съвет
- Q Заземяване със скоба

- I Качества
- II Активиране
- III Инсталиране
- IV Време на подаване
- V По време на подаване
- VI Смяна
- VII Бракуване
- VIII Отстраняване на грешки
- IX Обозначение



CS

Návod slouží k bezpečné práci na automatickém mazacím systému, který maže valivá a kluzná ložiska, řetězy, vedení, otevřené převody atd.



Mazací systém je určen pouze k jednorázovému použití a nesmí být otevřen nebo rozebírán.

Zamezte kontaktu oleje/tuku s očima, kůží a oblečením a požití oleje/tuku.

Zabraňte úniku oleje/tuku do půdy nebo do kanalizace.

Dodržujte bezpečnostní listy k olejům a tukům.



Datové listy maziv lze stáhnout na naší domovské stránce nebo získat od místního prodejce.

Nepřebíráme žádnou odpovědnost za škody a provozní poruchy, které vzniknou nesprávným používáním a neodbornou prací na mazacím systému.



Chraňte životní prostředí tím, že cenné suroviny dopravíte k recyklaci. Respektujte příslušné předpisy k likvidaci platné ve vaší zemi.

da

Vejlædningen skal bruges til sikkert arbejde på og med det automatiske smøresystem, som smører rulle- og glidelejer, kæder, føringer, åbne gear osv.



Smøresystemet må kun anvendes én gang og må ikke åbnes eller tages fra hinanden.

Undgå at olie/fedt kommer i kontakt med øjne, hud og beklædning, og undgå indtagelse af olie/fedt.

Olie/fedt må ikke trænge ned i jorden eller komme i kloakken.

Sikkerhedsdatablade for olier og fedt skal overholdes.



Smøremiddeldatablade kan hentes på vores hjemmeside eller hos lokale forhandlere.

Vi påtager os intet ansvar for skader og driftsforstyrrelser, der opstår som følge af forkert og u hensigtsmæssigt arbejde ved og med smøresystemet.



Beskyt miljøet, og genanvend værdifulde råstoffer i henhold til lokale bestemmelser.

- A Doba zásobování v měsících
- B Aktivační šroub
- C Podmínky skladování
- D Plynový generátor (kovová tableta)
- E Datum instalace/výměny
- F Uzavírací zátka
- G Odpad s obsahem tuku
- H Olej naplněn
- I Zádržný olejový ventil
- J Doba náběhu
- K V provozu
- L Prázdné
- M Správné množství maziva
- N Chyba
- O Příčina
- P Náprava
- Q Uzemnění s upevňovací objímkou

- I **Vlastnosti**
- II **Aktivace**
- III **Instalace**
- IV **Doby dodávky**
- V **Během doby dodávky**
- VI **Výměna**
- VII **Likvidace**
- VIII **Odstraňování poruch**
- IX **Označení**



- A Tømmeperiode i måneder
- B Aktiveringsskruer
- C Opbevaringsbetingelser
- D Gasgenerator (metaltablet)
- E Installations-/udskiftningsdato
- F Lukkeprop
- G Fedtholdigt affald
- H Olie fyldt
- I Olieventil
- J Opstarttid
- K I drift
- L Tom
- M Korrekt smøremængde
- N Fejl
- O Årsag
- P Afhjælpning
- Q Beskyttelsesleder med beslag

- I **Egenskaber**
- II **Aktivering**
- III **Installation**
- IV **Dispensertider**
- V **Under dispensertiden**
- VI **Udskiftning**
- VII **Bortskaffelse**
- VIII **Afhjælpning af fejl**
- IX **Mærkning**



el

Οι οδηγίες αποσκοπούν στην ασφαλή χρήση του αυτόματου συστήματος λίπανσης, μέσω του οποίου λιπαίνονται τα ρουλεμάν και τα έδρανα ολίσθησης, οι αλυσίδες, οι οδηγοί, τα ανοιχτά κιβώτια ταχυτήτων κ.τ.λ.



Το σύστημα λίπανσης θα πρέπει να χρησιμοποιείται μόνο μία φορά και δεν επιτρέπεται να ανοιχτεί ή να ξεμονταριστεί.

Αποφύγετε την επαφή του λαδιού/γράσου με τα μάτια, το δέρμα τα ρούχα καθώς και την κατάποση λαδιού/γράσου.

Το λάδι/γράσο δεν θα πρέπει να καταλήξει στο έδαφος ή στο αποχετευτικό δίκτυο.

Λάβετε υπόψη τα στοιχεία των δελτίων δεδομένων ασφαλείας των λαδιών και των γράσων.



Προστατεύετε το περιβάλλον προωθώντας στην ανακύκλωση τις πολύτιμες πρώτες ύλες. Τηρείτε τις εκάστοτε οδηγίες απόρριψης της χώρας σας.



Για να αποκτήσετε τα δελτία δεδομένων των λιπαντικών επισκεφτείτε την ιστοσελίδα μας ή απευθυνθείτε στους κατά τόπους αντιπροσώπους.

Δεν φέρουμε ουδεμία ευθύνη για ζημιές και προβλήματα λειτουργίας που οφείλονται σε αντικανονική χρήση ή ακατάλληλη μεταχείριση του συστήματος λίπανσης.

en

This operating manual is intended for the safe operation of the automatic lubrication system used for the lubrication of roller- and sliding bearings, chains, guidelines, open gears, etc.



The lubrication system was designed for a one-time use only. Do not open or take the unit apart!

Avoid contact of oil/grease with eyes, skin and clothing; also avoid swallowing of oil/grease.

Prevent oil/grease from getting into soil or sewer system.

Observe safety data sheets of oil/grease.



Protect the environment by recycling valuable raw material according to local regulations.



You may download lubricant data sheets from our web site or ask your local supplier.

We accept no liability for any damages and malfunctions which are caused by inappropriate usage and inappropriate operations on or with the lubricator.

- A Χρόνος παροχής σε μήνες
- B Βίδα ενεργοποίησης
- C Συνθήκες αποθήκευσης
- D Αεριοπαραγωγός (μεταλλικό πλακίδιο)
- E Ημερομηνία εγκατάστασης/αντικ.
- F Τάπα φραγής
- G Απορρίμματα που περιέχουν γράσα
- H Έγινε πλήρωση με λάδι
- I Βαλβίδα συγκράτησης λαδιού
- J Χρόνος εκκίνησης
- K Σε λειτουργία
- L Κενό
- M Σωστή ποσότητα λίπανσης
- N Σφάλμα
- O Αιτία
- P Τρόπος αντιμετώπισης
- Q Γείωση με κολιέ συγκράτησης

- I Ιδιότητες
- II Ενεργοποίηση
- III Εγκατάσταση
- IV Χρόνοι παροχής
- V Κατά τη διάρκεια του χρόνου παροχής
- VI Αντικατάσταση
- VII Διάθεση
- VIII Αντιμετώπιση σφαλμάτων
- IX Σήμανση



- A Discharge period in months
- B Activator screw
- C Storage conditions
- D Gas generator (metal pellet)
- E Installation-/Exchange date
- F Plug
- G Oil containing waste
- H Oil filled
- I Oil retaining valve
- J Time until first discharge
- K In operation
- L Empty
- M The right lubricant amount
- N Error
- O Cause
- P Corrective action
- Q Grounding with bracket

- I Properties
- II Activation
- III Installation
- IV Discharge periods
- V During operation
- VI Exchange
- VII Waste disposal
- VIII Trouble shooting
- IX Markings



es

Las instrucciones sirven para trabajar con seguridad en y con el sistema de lubricación automática, que lubrica rodamientos, cojinetes de deslizamiento, cadenas, guías, engranajes abiertos, etc.



Este sistema de lubricación es de un solo uso y no debe ser abierto ni desmontado.

Evitar el contacto de aceite/grasa con los ojos, la piel y la vestimenta, así como la ingestión de aceite/grasa.

No permitir que el aceite/la grasa llegue a la tierra ni al alcantarillado. Observar las hojas de datos de seguridad de los aceites y grasas.



Proteja el medio ambiente reciclando los materiales que puedan tener valor. Tenga en cuenta las directrices de eliminación de residuos pertinentes en su país.



Las hojas de datos de los lubricantes se pueden obtener en nuestra página principal o a través del distribuidor local.

No se asumirá la garantía por aquellos daños y anomalías de funcionamiento que se originen por haber utilizado inapropiadamente o por haber trabajado inadecuadamente en o con el sistema de lubricación.



- I Características**
- II Activación**
- III Instalación**
- IV Tiempo de lubricación**
- V Durante la lubricación**
- VI Cambio**
- VII Eliminación de residuos**
- VIII Eliminación de fallos**
- IX Distintivo**

- A** Tiempo de dosificación en meses
- B** Tornillo activador
- C** Condiciones de almacenamiento
- D** Generador de gas (pastilla metálica)
- E** Fecha de instalación/cambio
- F** Tapón cierre
- G** Residuos con grasa
- H** Relleno con aceite
- I** Válvula dosificadora de aceite
- J** Tiempo de puesta en marcha
- K** En funcionamiento
- L** Vacío
- M** Cantidad correcta a dosificar
- N** Error
- O** Causa
- P** Remedio
- Q** Derivación en tierra con abrazadera

fi

Ohjeiden tarkoitus on varmistaa automaattisen rulla- ja liukulaakereita, ketjuja, kiskoja, avonaisia vaihteistoja jne. voitelevan voitelujärjestelmän turvallinen käyttäminen.



Voitelujärjestelmä on kertakäyttöinen, eikä sitä saa avata tai purkaa.

Vältä öljyn/rasvan joutumista kosketuksiin silmien, ihon tai vaatteiden kanssa. Vältä öljyn/rasvan nielemistä.

Älä päästä öljyä/rasvaa maaperään tai viemäriverkkoon.

Noudata öljyn ja rasvan tuotiedoissa annettuja ohjeita.



Suojaa ympäristöä kierrättämällä arvokkaat raaka-aineet. Huomioi maassasi voimassa olevat jätehuoltomääräykset.



Voit ladata voiteluaineiden tuotetiedot Internet-sivuiltamme tai pyytää niitä paikalliselta jälleenmyyjältä.

Emme vastaa vaurioista ja käyttöhäiriöistä, jotka johtuvat voiteluainejärjestelmän epäasianmukaisesta käytöstä tai epäasianmukaisesta työskentelystä järjestelmän parissa.



- I Ominaisuudet**
- II Aktivointi**
- III Asennus**
- IV Käyttöajat**
- V Käyttöajan aikana**
- VI Vaihteisto**
- VII Hävitys**
- VIII Vian etsintä**
- IX Merkintä**

- A** Syöttöjakson pituus kuukausissa
- B** Aktivointiruuvi
- C** Varastoinnin edellytykset
- D** Kaasuntuottaja (metallitabletti)
- E** Asennus-/vaihtopäivämäärä
- F** Kiristystulppa
- G** Rasvapitoinen jäte
- H** Öljytäyteinen
- I** Öljyn kuristusventtiili
- J** Käynnistysaika
- K** Käytössä
- L** Tyhjä
- M** Oikea voiteluainemäärä
- N** Vika
- O** Syy
- P** Vian poisto
- Q** Maadoitus kiinnikkeen kautta

fr

Les instructions ont pour but d'assurer un travail en toute sécurité du et avec le système de lubrification automatique alimentant les paliers à roulement, les paliers lisses, les chaînes, les guidages et les engrenages ouverts, etc.



Le système de graissage n'est utilisable qu'une seule fois et ne doit pas être ouvert, ni démonté.

Éviter le contact de l'huile/de la graisse avec les yeux, la peau et les vêtements et éviter l'ingestion d'huile/de graisse.

L'huile/la graisse ne doit pas pénétrer dans le sol ou dans la canalisation. Respecter les fiches techniques de sécurité des huiles et des graisses.



Les fiches de données des lubrifiants sont téléchargeables sur notre site web ou peuvent être demandées auprès du service commercial.

Nous ne pouvons pas être tenus responsables de dommages et dérangements résultant d'une utilisation non conforme et d'un mode de travail non correct avec et du système de lubrification.



Protégez l'environnement en vous assurant que les matières premières de valeur soient recyclées. Respectez les directives d'élimination des déchets en vigueur dans votre pays.

hu

Ennek az útmutatónak a célja, hogy biztonságosan végezhesen munkát az automatikus kenőrendszeren, illetve kenőrendszerrel, amely gördülő- és siklócsapágyak, láncok, vezetékek, nyitott hajtóművek stb. kenését látja el.



A kenőrendszert csak egyszer kell alkalmazni, és nem szabad felnyitni vagy szétszedni.

Kerülje az olaj és a zsír érintkezését a szemmel, bőrrel és ruházzal, valamint ne nyelje le az olajat és a zsírt.

Ne engedje, hogy olaj vagy zsír a talajba vagy a csatornahálózatba kerüljön.

Vegye figyelembe az olajok és zsírok biztonsági adatlapjait.



A kenőanyagok adatait a honlapunkról vagy beszerezhetők a helyi forgalmazótól.

Olyan károkért és üzemzavarokért, amelyek a kenőrendszer rendeltetésellenes használata, vagy a kenőrendszeren, illetve a kenőrendszerrel szakszerűtlenül végzett munkák miatt keletkeznek, nem vállalunk felelősséget.



Óvja a környezetet az értékes nyersanyagok újrahasznosításával. Vegye figyelembe az adott ország ártalmatlanításra vonatkozó mindenkor érvényes irányelveit.

- A Durée de distribution en mois
- B Vis d'activation
- C Conditions de stockage
- D Générateur de gaz (Pastille d'alliage métallique)
- E Date de l'installation/remplacement
- F Bouchon d'obturation
- G Déchets contenant de la graisse
- H Rempli avec de l'huile
- I Clapet limiteur de débit
- J Temps de démarrage
- K En service
- L Vide
- M Quantité de graisse juste
- N Erreurs
- O Cause
- P Remède
- Q La mise à la terre avec collier de serrage

- I Propriétés
- II Activation
- III Installation
- IV Durée de distribution
- V Pendant la durée de distribution
- VI Remplacement
- VII Elimination
- VIII Dépannage
- IX Identification



- A Adagolási idő hónapokban
- B Aktiválósavár
- C Tárolási feltételek
- D Gázfejlesztő (fémtabletta)
- E Telepítés/csere dátuma
- F Záródugó
- G Olajos hulladék
- H Olaj feltöltve
- I Olajfejlesztőszelep
- J Bemelegedési idő
- K Bekapcsolva
- L Üres
- M Megfelelő kenési mennyiség
- N Hiba
- O Ok
- P Elhárítás
- Q Földelés tartóbilinccsel

- I Tulajdonságok
- II Aktiválás
- III Telepítés
- IV Adagolási idők
- V Használat közben
- VI Csere
- VII Ártalmatlanítás
- VIII Hibaelhárítás
- IX Jelölés



it

Le presenti istruzioni per l'uso sono concepite per il funzionamento sicuro del sistema automatico per la lubrificazione di cuscinetti volenti, cuscinetti lisci, catene, guide, ingranaggi scoperti, ecc.



Il sistema di lubrificazione non è riutilizzabile e non deve essere aperto né smontato.

Evitare che l'olio/il grasso entri in contatto con occhi, pelle e abiti; non ingerire l'olio o il grasso.

Evitare che l'olio/il grasso penetri nel terreno o nel sistema fognario.

Prestare attenzione alle schede tecniche di sicurezza di oli e grassi.



Le schede dei lubrificanti si possono anche scaricare tramite la nostra homepage oppure richiedere al rivenditore locale.

Non si assume alcuna responsabilità per danni o anomalie di funzionamento dovuti a un utilizzo improprio del sistema di lubrificazione o a interventi non appropriati eseguiti sullo stesso.



Tutelate l'ambiente avviando al riciclaggio le pregiate materie prime. Rispettate sempre le direttive sullo smaltimento vigenti nel vostro paese.

ja

本書は自動潤滑システム、転がり軸受、滑り軸受け、チェーン、ガイドやギアなどでの安全な作業を確保するための説明書です。



潤滑システムは絶対に再使用しないでください。また、開いたり解体したりしてはなりません。

オイル/グリースが目、皮膚や衣類につかないよう、また、オイル/グリースを飲み込まないようご注意ください。

オイル/グリースを地面や下水に流さないでください。

オイルとグリースの安全データシートをご参照ください。



潤滑油のデータシートは弊社ホームページ又は販売店でご入手いただけます。

潤滑システムの不適正使用又は不適正作業による損害や故障につきましては、弊社では責任を負いかねます。



貴重な資源はリサイクルし、環境保護に努めてください。また、ご使用地域における廃棄に関する規定を順守してください。

- A Erogazione in mesi
- B Vite di attivazione
- C Condizioni di conservazione
- D Elemento gasogeno (compressa metallica)
- E Data di installazione/sostituzione
- F Tappo chiusura
- G Rifiuti contenenti olio
- H Riempito con olio
- I Valvola per olio
- J Tempo di avvio
- K In funzione
- L Vuoto
- M Quantità corretta di lubrificante
- N Errore
- O Causa
- P Azione correttiva
- Q Messa a terra con fascetta

- I Proprietà
- II Attivazione
- III Installazione
- IV Periodi di erogazione
- V Durante il periodo di erogazione
- VI Sostituzione
- VII Smaltimento
- VIII Eliminazione degli errori
- IX Contrassegno



- A 供給周期 (月)
- B 起動ネジ
- C 保管条件
- D ガス生成物質(メタルペレット)
- E 設置日 / 交換日
- F 栓
- G 油性廃棄物
- H オイル充填
- I オイル止めバルブ
- J 起動時間
- K 稼働中
- L 空
- M 適正潤滑量
- N エラー
- O 原因
- P 解決策
- Q 保持クランプで接地 (アース) を取ります

- I 特徴
- II 起動
- III 設置
- IV 吐出期間
- V 運転中
- VI 交換
- VII 廃棄
- VIII トラブルシューティング
- IX マーク





nl

De handleiding dient voor veilig werken aan en met het automatische smeersysteem dat wentel- en glijlagers, kettingen, geleidingen, open aandrijvingen enz. smeert.



Het smeersysteem mag slechts één keer worden gebruikt en mag niet worden geopend of uit elkaar worden genomen.

Vermijd het contact met ogen, huid en kleding met de olie en/of het vet. Vermijd de inname van olie en vet.

Vergewis U ervan dat de olie en/of het vet niet in de afvoer of de bodem terecht komen.

Veiligheidsinformatiebladen van olie en vetten in acht nemen.



Smeermiddel informatiebladen kunnen via onze homepage of bij de plaatselijke handelaar worden aangevraagd.

Wij kunnen niet verantwoordelijk worden gesteld voor schade en bedrijfsstoringen die het gevolg zijn van gebruik in strijd met de voorschriften en door ondeskundig werken aan en met het smeersysteem.



Bescherm het milieu door waardevolle grondstoffen en materialen in te leveren voor recycling. Volg de nationale regelgeving over afvalverwerking.

no

Veiledningen skal følges for sikkert arbeid på og med det automatiske smøresystemet, som smører rulle- og glidelager, kjeder, føringer, åpne gir osv.



Smøresystemet må bare brukes én gang og må ikke åpnes eller tas fra hverandre.

Unngå at øyne, hud og klær kommer i kontakt med olje/fett, og unngå å svelge olje/fett.

Sørg for at olje/fett ikke kommer ned i bakken eller i havner i avløpssystemet.

Følg sikkerhetsdatablader for olje og fett.



Datablader for smøremidler er tilgjengelige på vår hjemmeside eller fra din lokale forhandler.

Det tas intet ansvar for skader og driftsfeil som skyldes feil bruk og ikke forskriftsmessig arbeid på og med smøresystemet.



Beskytt miljøet, ved at verdifulle råstoffer tilføres gjenvinning. Vær oppmerksom retningslinjene for avfallshåndtering til de landet ditt.

- A Afgifte tid i maanden
- B Activeringsschroef
- C Opslagvoorwaarden
- D Gasgenerator (metaaltabte)
- E Datum installatie/verversen
- F Sluitdop
- G Vethoudend afval
- H Met olie gevuld
- I Olie terugslagventiel
- J Aanlooptijd
- K In werking
- L Leeg
- M Correcte smeerhoeveelheid
- N Fout
- O Oorzaak
- P Maatregel
- Q Aarding met montageklem

- I Eigenschappen
- II Activering
- III Installatie
- IV Afgiftetijden
- V Tijdens de afgiftetijd
- VI Verversen
- VII Afvalafvoer
- VIII Verhelpen van fouten
- IX Kenmerk



- A Tømmeperiode i måneder
- B Aktiveringsskrue
- C Lagringsbetingelser
- D Gassgenerator (metalltablett)
- E Dato for installasjon/bytte
- F Stopplugg
- G Fettholdig avfall
- H Oljefyll
- I Olje tilbakeslags ventil
- J Starttid
- K I drift
- L Tom
- M Riktig smøremengde
- N Feil
- O Årsak
- P Tiltak
- Q Brakett med jording

- I Egenskaper
- II Aktivering
- III Installasjon
- IV Dispenseringstider
- V I dispenseringstiden
- VI Bytte
- VII Deponering
- VIII Utbedring av feil
- IX Merking



pl

Zadaniem niniejszej instrukcji jest zapewnienie bezpiecznej eksploatacji automatycznego układu smarowania przeznaczonego do łożysk tocznych i ślizgowych, łańcuchów, przewodnic, otwartych przekładni, itp.



Układu smarowania można użyć tylko raz, a także nie można go otwierać ani rozmontowywać.

Unikać kontaktu oleju/smaru z oczami, skórą i ubraniem oraz połknięcia oleju/smaru.

Nie dopuścić do dostania się oleju/smaru do gleby lub kanalizacji.

Przestrzegać wskazówek podanych w kartach charakterystyki olejów i smarów.



Należy chronić środowisko naturalne, przekazując wartościowe surowce do ponownego wykorzystania. Należy przestrzegać wytycznych dotyczących utylizacji obowiązujących w poszczególnych krajach.



Karty informacyjne smarów są dostępne na naszej stronie internetowej lub u lokalnego dystrybutora.

Producent nie ponosi odpowiedzialności za szkody i usterki spowodowane niewłaściwym stosowaniem oraz nieprawidłowym użytkowaniem układu smarowania.

pt

O manual destina-se a trabalhar em segurança no e com o sistema de lubrificação automático que lubrifica chumaceiras de fricção e de rolamentos, correntes, guias, engrenagens abertas, etc.



O sistema de lubrificação só pode ser usado uma única vez e não pode ser aberto nem desmontado.

Evitar o contacto do óleo/massa com os olhos, pele e vestuário bem como a ingestão de óleo/massa.

Não deixar escorrer óleo/massa para o solo ou para os esgotos.

Ter em atenção as fichas de dados de segurança dos óleos e massas.



Proteja o meio ambiente reciclando as matérias-primas valiosas. Respeite as diretivas de reciclagem válidas no seu país.

As fichas de dados do lubrificante podem ser obtidas através da nossa página principal ou no distribuidor local.

Não são assumidas quaisquer responsabilidades por danos e avarias que sejam causados por utilização incorrecta ou trabalhos incorrectos no e com o sistema de lubrificação.

- A Czas dozowania w miesiącach
- B Śruba uruchamiająca
- C Warunki przechowywania
- D Generator gazu (płytk metalowa)
- E Data instalacji/wymiany
- F Korek
- G Odpad zawierający smar
- H Napelniony olejem
- I Zawór zwrotny oleju
- J Czas rozruchu
- K Pracuje
- L Pusto
- M Prawidłowa ilość smaru
- N Błąd
- O Przyczyna
- P Pomoc
- Q Uziemienie z obejmą trzymającą

### I Właściwości

- II Aktywacja
- III Instalacja
- IV Czasy dozowania
- V W czasie dozowania
- VI Wymiana
- VII Utylizacja
- VIII Usuwanie usterek
- IX Oznaczenie



- A Período de distribuição em meses
- B Parafuso de activação
- C Condições de armazenamento
- D Gerador de gás (pastilha metálica)
- E Data de instalação e substituição
- F Tampão vazamento
- G Resíduos com lubrificação
- H Abastecido de óleo
- I Válvula de retenção de óleo
- J Tempo de arranque
- K Em funcionamento
- L Vazio
- M Quantidade correcta de lubrificante
- N Erro
- O Causa
- P Suporte
- Q Ligação a terra com braçadeira de suporte

### I Características

- II Activação
- III Instalação
- IV Períodos de lubrificação
- V Durante o período de lubrificação
- VI Substituição
- VII Eliminação
- VIII Eliminação do erro
- IX Marcação



RO

Manualul servește siguranței în lucru la și cu sistemul automat de lubrifiere, sistem care lubrifiază rulmenții și lagărele de alunecare, lanțurile, ghidajele, transmisiile deschise etc.



Sistemul de lubrifiere poate fi folosit o singură dată și nu are voie să fie desfăcut sau demontat.

Evitați contactul uleiului/unsorii cu ochii, pielea și îmbrăcămintea și ingerarea uleiului/unsorii.

Nu este permisă deversarea uleiului/unsorii în sol sau în canalizare.

Respectați fișele cu datele de securitate pentru uleiuri și unsoari.



Fișele cu date despre lubrifianț pot fi procurate de pe pagina noastră de internet sau de la distribuitorul local.

Nu ne asumăm răspunderea pentru deteriorările și disfuncționalitățile apărute datorită utilizării abuzive și lucrărilor efectuate necorespunzător la sistemul de lubrifiere și cu acesta.



Protejați mediul prin reciclarea materiilor prime valoroase. Țineți seama de directivele privind reciclarea aplicabile în țara dumneavoastră.

- A Durată de aplicare (în luni de zile)
- B Șurub de activare
- C Condiții de depozitare
- D Generator de gaz (tableată metalică)
- E Data de instalare/schimbare
- F Bușoane
- G Deșeu cu conținut de unsoare
- H Umplut cu ulei
- I Supapă de reținere a uleiului
- J Timp de pornire
- K În funcțiune
- L Gol
- M Cantitate corectă de lubrifianț
- N Eroare
- O Cauza
- P Soluționare
- Q Împământare cu bridă de fixare

- I Proprietăți
- II Activare
- III Instalarea
- IV Durate de dispensare
- V În timpul perioadei de dispensare
- VI Schimbarea
- VII Eliminarea ca deșeu
- VIII Remedierea defectiunii
- IX Identificare



RU

Данное руководство служит для обеспечения безопасности работ с автоматической смазочной системой, предназначенной для смазывания подшипников качения и скольжения, цепей, направляющих, открытых редукторов и т. д.



Смазочную систему следует использовать только один раз, не разрешается открывать или разбирать смазочную систему. Избегайте контакта масла/смазки с глазами, кожей и одеждой, а также избегайте проглатывания масла/смазки. Не допускать попадания масла/смазки в грунт или канализацию. Соблюдать данные в паспортах безопасности на масла и смазки.



Паспорта безопасности на смазочные материалы можно заказать через нашу домашнюю страницу или у локального дилера.

Мы не берем на себя ответственность за повреждения и эксплуатационные сбои, вызванные ненадлежащим применением и неправильной работой со смазочной системой.



В целях охраны окружающей среды передавайте ценное сырье на вторичную переработку. Придерживайтесь положений по утилизации, действующих в Вашей стране.

- A Время подачи в месяцах
- B Вит активирования
- C Условия хранения
- D Газогенератор (металлическая таблетка)
- E Дата установки/замены
- F Заглушка
- G Отходы, содержащие смазку
- H Масло залито
- I Масляный запорный клапан
- J Время пуска
- K В рабочем режиме
- L Пуста
- M Правильное количество смазки
- N Ошибка
- O Причина
- P Устранение
- Q Заземление с зажимом

- I Характеристики
- II Активирование
- III Установка
- IV Время подачи
- V Во время подачи
- VI Замена
- VII Утилизация
- VIII Устранение ошибок
- IX Маркировка



sk

Tento návod podporuje bezpečnú prácu s automatickým mazacím systémom, ktorým sa mažu valivé a klznú ložiská, reťaze, riadenia, otvorené prevodovky, a podobne.



Mazací systém sa musí použiť iba raz a nesmie sa otvárať ani rozoberať.

Vyhýbajte sa kontaktu očí, pokožky a odevu s olejmi či tukmi, ako aj požitiu olejov či tukov.

Neznečisťujte pôdu olejmi ani tukmi, ani ich nevypúšťajte do kanalizácie.

Všimnite si hácky bezpečnostných údajov olejov a tukov.



Dátové listy mazív si môžete stiahnuť z našej domovskej stránky alebo ich získajte od miestnych dodávateľov.

Nepreberáme žiadnu zodpovednosť za škody a prevádzkové poruchy, ktoré vznikli v dôsledku neodborného používania a nesprávnej obsluhy mazacieho systému.



Cenné suroviny odovzdávajte na recykláciu a chráňte tak životné prostredie. Riadte sa príslušnými predpismi pre likvidáciu vo vašej krajine.

sl

Navodila so namenjena za varno uporabo in varno delo na samodejnem mazalnem sistemu za mazanje valjčnih in drsnih ležajev, verig, vodil, odprtih menjalnikov itd.



Mazalni sistem lahko uporabite samo enkrat in ga ni dovoljeno odpirati ali razstavljati.

Preprečite stik z očmi, kožo ali oblačili zaradi olja/masti in zauživanja olj/masti.

Olje/mast ne sme preiti v zemljo ali v kanalizacijo.

Upoštevajte varnostne podatkovne liste olj in masti.



Podatkovne liste mazív najdete na naši spletni strani ali jih dobite pri lokalnih prodajalcih.

Ne prevzemamo odgovornosti za škodo in motnje delovanja, ki nastanejo zaradi nepravilne uporabe in nestrokovnih del na in z mazalnim sistemom.



Poskrbite za varstvo okolja tako, da oddate dragocene surovine v recikliranje. Upoštevajte veljavne lokalne predpise za odstranjevanje.

- A Doba poskytovania v mesiacoch
- B Aktivačná skrutka
- C Podmienky skladovania
- D Vyvíjač plynu (kovová tableta)
- E Dátum inštalácie/výmeny
- F Uzatváracie zátky
- G Odpad s obsahom tuku
- H Olej naplnený
- I Retenčný ventil oleja
- J Doba rozbehu
- K V prevádzke
- L Prázdna
- M Správne mazacie množstvo
- N Poruchy
- O Príčiny
- P Pomoc
- Q Uzemnenie s pridržiavacou sponou

- I **Vlastnosti**
- II **Aktivácia**
- III **Inštalácia**
- IV **Doby dávkovania**
- V **Počas doby dávkovania**
- VI **Výmena**
- VII **Likvidácia odpadu**
- VIII **Odstraňovanie porúch**
- IX **Identifikácia**



- A Čas doziranja v mesecih
- B Vijak za aktiviranje
- C Pogoji skladiščenja
- D Uplinjevalnik (kovinska tableta)
- E Datum namestitve/zamenjave
- F Zaporni čep
- G Odpadki, ki vsebujejo maščobe
- H Napolnjeno z oljem
- I Zadrževalni ventil za olje
- J Zagonski čas
- K Deluje
- L Prazno
- M Pravilna količina maziva
- N Napaka
- O Vzrok
- P Pomoč
- Q Ozemljitev z oporno objemko

- I **Lastnosti**
- II **Aktiviranje**
- III **Namestitve**
- IV **Trajanje dispenzerja**
- V **Med trajanjem dispenzerja**
- VI **Zamenjava**
- VII **Odstranjevanje**
- VIII **Odpravljajte težave**
- IX **Oznaka**



SV

Anvisningarna är till för säkert arbete på och med det automatiska smörjsystemet som smörjer rull- och glidlager, kedjor, styrningar, öppna transmissioner etc.



Smörjsystemet får endast användas en gång och får inte öppnas eller plockas isär.

Undvik kontakt med ögon, hud och kläder genom olja/fett och att svälja olja/fett.

Låt inte olja/fett komma ner i jorden eller i avloppssystemet.

Beakta säkerhetsdatabladet för oljorna och fetterna.



Skona miljön genom återföra värdefulla råämnen till återvinning. Beakta landets regler om avfallhantering.



Smörjmedelsdatablad kan fås via vår webbplats eller från lokala handlare. Vi ansvarar inte för skador och driftstörningar som uppstår genom felaktig användning och genom ej fackmässigt arbete på och med smörjsystemet.

tr

Kullanım kılavuzunun amacı, otomatik yağlama sistemlerinde güvenli çalışmayı sağlamaktır. Bu yağlama sistemi rulman yatakları, kayar yataklar, zincirler, kılavuzlar, açık tahrikleri vs. yağlamak için kullanılır.



Yağlama sistemi sadece bir kere kullanılabilir, açılmamalıdır veya parçalara ayrılmalıdır.

Yağın/gresin göz, cilt ve kıyafetle teması engellenmelidir, yağ/gres yutulmamalıdır.

Yağ/gres toprak alana veya kanalizasyona ulaşmamalıdır.

Yağların ve greslerin Güvenlik Bilgi Form'ları dikkate alınmalıdır.



Değerli ham maddeleri geri dönüşüme sevk ederek çevreyi koruyun. Ülkenizin ilgili imha yönetmeliklerini dikkate alın.



Yağlama maddelerine ait veri formları, internet sitemizden veya yerel satıcıdan temin edilebilir.

Yağlama sisteminin öngörülen şekilde kullanılmamasından dolayı ve sistem üzerinde veya sistem ile birlikte yapılan uygunsuz çalışmalar nedeniyle oluşan hasarlar ve işletim arızaları için hiçbir sorumluluk üstlenilmez.

- A Tömningstid i månader
- B Aktiveringsskruv
- C Lagringsvillkor
- D Gasgenerator (metalltablett)
- E Installation-/utbytesdatum
- F Plugg
- G Fetthaltigt avfall
- H Oljefyll
- I Backventil
- J Starttid
- K I drift
- L Tom
- M Korrekt smörjmängd
- N Fel
- O Orsak
- P Åtgärd
- Q Jordning i fästpunkt

- I Egenskaper
- II Aktivering
- III Installation
- IV Tömningstider
- V Under tömningstiden
- VI Byte
- VII Avfallshantering
- VIII Åtgärdande av fel
- IX Märkning



- A Yağlama zamanı ay olarak
- B Etkinleştirme civatası
- C Depolama koşulları
- D Gaz jeneratörü (metal tablet)
- E Kurulum/değiştirme tarihi
- F Tapa
- G Yağ içerikli atık
- H Yağ doldurulmuş
- I Yağ tutma valfi
- J Başlama süresi
- K Çalışıyor
- L Boş
- M Doğru yağlama miktarı
- N Arıza
- O Neden
- P Çözüm
- Q Tutucu kelepçe ile topraklama

- I Özellikler
- II Etkinleştirme
- III Kurulum
- IV Yağlama zamanları
- V Yağlama zamanı esnasında
- VI Değişimi
- VII Bertaraf
- VIII Arıza giderme
- IX İşaretleme



zh

此操作指南是滚动轴承、滑动轴承、链条、滑槽、开放式传动装置的自动化润滑系统的安全工作指南。



润滑系统只能使用一次，不能打开或者拆卸。

避免眼睛、皮肤和衣物接触到润滑油/润滑脂，避免吞食润滑油/润滑脂。

不要把润滑油/润滑脂排放到土壤或下水道中。

注意润滑油和 润滑脂的安全数据表。



可以登录我们的网站下载或从当地经销商处索取润滑材料数据说明表。

如果由于对润滑系统的错误使用或不当操作造成了损失和运行故障，我们不对此类损失和故障承担责任。



为了保护环境，根据当地法律循环利用有价值的原料。

- A 有效使用时间，单位：月
- B 活化螺钉
- C 存放条件
- D 气体发生器（金属盘片）
- E 安装日期/更换日期
- F 密封塞
- G 含油脂的废物
- H 灌满润滑油
- I 油保留阀
- J 起动时间
- K 运行中
- L 空了
- M 适当的滑润量
- N 故障
- O 原因
- P 补救
- Q 带夹具的接地

- I 性能
- II 激活
- III 安装
- IV 有效使用时间
- V 在有效使用期间内
- VI 更换
- VII 废物处理
- VIII 故障排除
- IX 标记



---

---

---

---

---

---

---

---

---

---



---

---

---

---

---

---

---

---

---

---