

Book-style EMC/RFI Filter for Inverters and Power Drive Systems

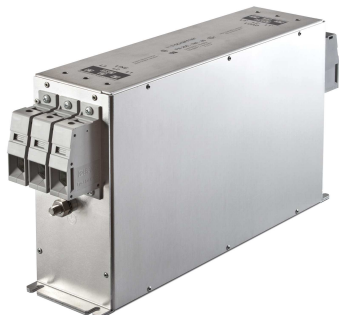

- Industry standard EMC solution for three-phase PDS filtering
- Slim space-saving book-style housing
- Solid safety connector blocks or optional wire output connections
- Excellent attenuation performance
- HV versions for up to 690 VAC
- HVIT versions for IT distribution networks
- P/L versions with low leakage current



Performance indicators

Attenuation performance



Rated current [A]

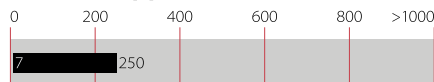

Approvals



UL/CSA: FN 258 up to 180 A (ex. -180-07)

Features and benefits

- FN 258 range of filters provides state-of-the-art EMI attenuation based on an innovative multi-stage filter topology. They help to ensure compliance with Class A or even Class B limits
- The slim book-style shape allows a convenient and space-saving installation next to inverters and motor drives
- With 480 VAC rating and filter modules from 7 to 250 A, FN 258 are ready for the most diverse applications worldwide
- FN 258 HV filters up to 130 A are designed for 690 VAC distribution networks
- FN 258 HVIT filters up to 130 A meet the special requirements for the application in industrial 690 VAC IT distribution networks
- FN 258 L and FN 258 P filters help to fulfill tough requirements in respect of leakage current limitation and provide an excellent solution to overcome problems with nuisance tripping of sensitive earth leakage detectors

Technical specifications

Maximum continuous operating voltage	3x 480/277 VAC (FN 258, FN 258 L, FN 258 P) 3x 690/400 VAC (FN 258 HV, FN 258 HVIT)
Rated currents	7 to 250 A @50°C (480 V filters)
Operating frequency	dc to 60 Hz
High potential test voltage	P → E 2650 VDC for 2 sec (480 V filters) P → P 2100 VDC for 2 sec (480 V filters) P → E 3100 VDC for 2 sec (690 V filters) P → P 3000 VDC for 2 sec (690 V filters)
Protection category	IP 20
Overload capability	4x rated current at switch on, 1.5x rated current for 1 minute, once per hour
Temperature range (operation and storage)	-25°C to +100°C (25/100/21)
Flammability corresponding to	UL 94 V-2 or better
Design corresponding to	UL 1283, CSA 22.2 No. 8 1986, IEC/EN 60939
MTBF @ 50°C/400 V (Mil-HB-217F)	220,000 hours

Typical applications

- Three-phase variable speed drives and power drive systems (PDS)
- IT power distribution networks (FN 258 HVIT)
- Applications comprising energy conversion devices (inverters, converters)
- Process automation equipment
- Three-phase power supplies and UPS
- Applications with low-leakage current requirements (FN 258 L and FN 258 P)

Typical electrical schematic

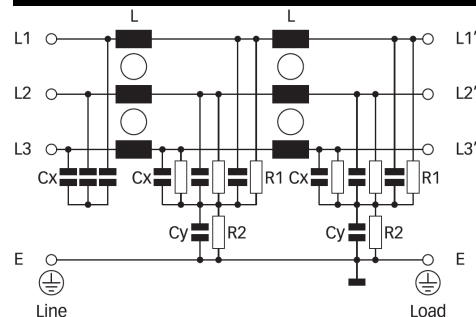

Note: HVIT versions without discharge resistor to ground.

Filter selection table

Filter*	Rated current	Typical drive	Leakage current***	Power loss	Input connections	Output connections		Weight [kg]
	@ 50°C (40°C) [A]	power rating** [kW]	@ 440 VAC/50 Hz [mA]	@ 25°C/50 Hz [W]				
FN 258-7-..	7 (7.7)	4	16.5	9	-29	-07	-29	1.0
FN 258-16-..	16 (17.5)	7.5	18.3	20	-29	-07	-29	1.4
FN 258-30-..	30 (33)	15	24.2	21	-33	-07	-33	1.7
FN 258-42-..	42 (46)	22	25.8	30	-33	-07	-33	2.5
FN 258-55-..	55 (60)	30	25.8	30	-34	-07	-34	2.9
FN 258-75-34	75 (82)	37	25.8	24	-34		-34	3.9
FN 258-100-35	100 (110)	55	25.8	51	-35		-35	5.5
FN 258-130-35	130 (143)	75	30.0	50	-35		-35	6.9
FN 258-180-..	180 (197)	90	30.0	73	-40	-07	-40	11.0
FN 258-250-..	250 (275)	132	30.0	79	-40	-07	-40	12.0
FN 258 HV-7-29	7 (7.7)	5.5	13.0	9	-29		-29	1.0
FN 258 HV-16-29	16 (17.5)	11	19.0	20	-29		-29	1.5
FN 258 HV-30-33	30 (33)	22	19.0	21	-33		-33	1.8
FN 258 HV-42-33	42 (46)	30	21.6	30	-33		-33	2.6
FN 258 HV-55-34	55 (60)	45	21.6	30	-34		-34	3.0
FN 258 HV-75-34	75 (82)	55	21.6	24	-34		-34	4.3
FN 258 HV-100-35	100 (110)	90	21.6	51	-35		-35	5.6
FN 258 HV-130-35	130 (143)	110	25.0	50	-35		-35	7.1
FN 258 HVIT-7-29	7 (7.7)	5.5	13.0	9	-29		-29	1.0
FN 258 HVIT-16-29	16 (17.5)	11	19.0	20	-29		-29	1.5
FN 258 HVIT-30-33	30 (33)	22	19.0	21	-33		-33	1.8
FN 258 HVIT-42-33	42 (46)	30	21.6	30	-33		-33	2.6
FN 258 HVIT-55-34	55 (60)	45	21.6	30	-34		-34	3.0
FN 258 HVIT-75-34	75 (82)	55	21.6	24	-34		-34	4.3
FN 258 HVIT-100-35	100 (110)	90	21.6	51	-35		-35	5.6
FN 258 HVIT-130-35	130 (143)	110	25.0	50	-35		-35	7.1
FN 258 L-7-..	7 (7.7)	4	0.8	9	-29	-07	-29	1.0
FN 258 L-16-..	16 (17.5)	7.5	0.8	20	-29	-07	-29	1.4
FN 258 L-30-..	30 (33)	15	0.8	21	-33	-07	-33	1.7
FN 258 L-42-..	42 (46)	22	0.7	30	-33	-07	-33	2.5
FN 258 L-55-..	55 (60)	30	0.7	30	-34	-07	-34	2.9
FN 258 L-75-34	75 (82)	37	0.7	24	-34		-34	3.9
FN 258 L-100-35	100 (110)	55	0.7	51	-35		-35	5.5
FN 258 L-130-35	130 (143)	75	0.7	50	-35		-35	6.9
FN 258 L-180-..	180 (197)	90	0.7	73	-40	-07	-40	11.0
FN 258 L-250-07	250 (275)	132	0.7	79	-40	-07		12.0
FN 258 P-7-..	7 (7.7)	4	3.3	9	-29	-07	-29	1.0
FN 258 P-16-..	16 (17.5)	7.5	3.3	20	-29	-07	-29	1.4
FN 258 P-30-..	30 (33)	15	3.3	21	-33	-07	-33	1.7
FN 258 P-42-..	42 (46)	22	3.5	30	-33	-07	-33	2.5
FN 258 P-55-..	55 (60)	30	3.5	30	-34	-07	-34	2.9
FN 258 P-75-34	75 (82)	37	3.5	24	-34		-34	3.9
FN 258 P-100-35	100 (110)	55	3.5	51	-35		-35	5.5
FN 258 P-130-35	130 (143)	75	3.5	50	-35		-35	6.9
FN 258 P-180-..	180 (197)	90	3.5	73	-40	-07	-40	11.0
FN 258 P-250-07	250 (275)	132	3.6	79	-40	-07		12.0

* To compile a complete part number, please replace the -.. with the required output connection style.

** Calculated at rated current, 440 VAC (FN 258)/690 VAC (FN 258 HV) and $\cos \phi=0.8$. The exact value depends upon the efficiency of the drive, the motor and the entire application.

***Maximum leakage under normal operating conditions (FN 258 at 440 V, FN 258 HV at 690 V). Note: if two phases are interrupted, worst case leakage could reach 5.7 times higher levels.

Typical filter attenuation

Per CISPR 17; A=50 Ω/50 Ω sym; B=50 Ω/50 Ω asym; C=0.1 Ω/100 Ω sym; D=100 Ω/0.1 Ω sym

7 to 30 A types

42 to 100 A types

130 A types

180 and 250 A types

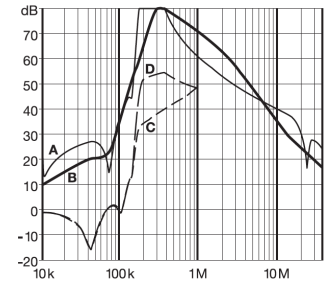
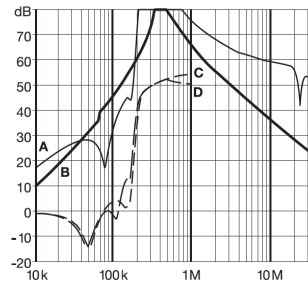
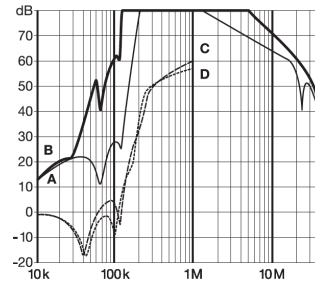
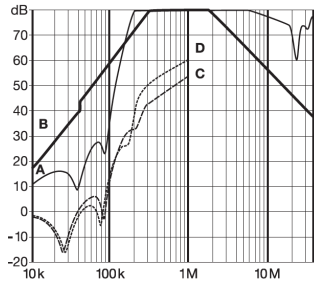

Note: typical attenuation performance of FN 258 standard filters. The behavior of FN 258 HV, FN 258 HVT, FN 258 P and FN 258 L may be slightly different.

Mechanical data

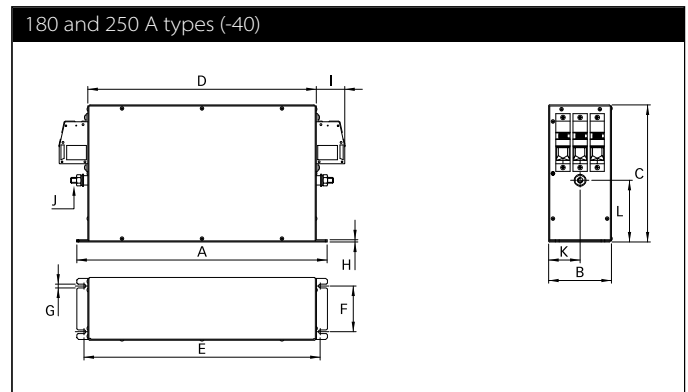
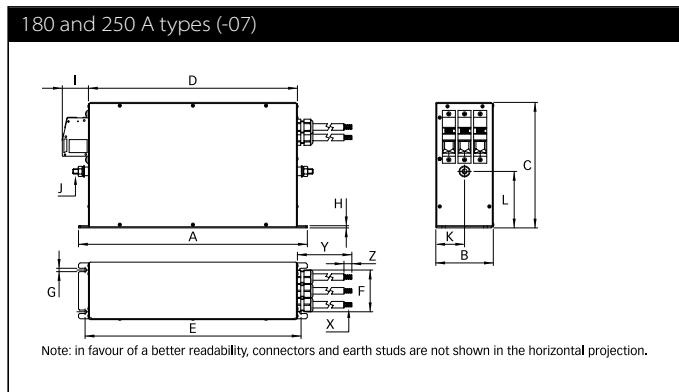
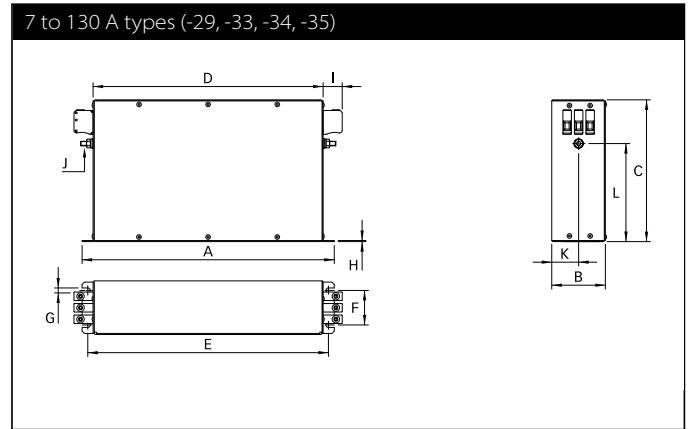
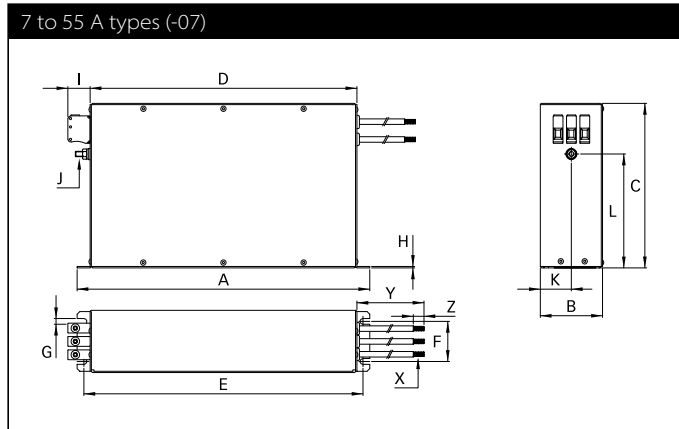

Note: in favour of a better readability, connectors and earth studs are not shown in the horizontal projection.

Dimensions





	7 A	16 A	30 A	42 A	55 A	75 A	100 A	130 A	180 A	250 A
A	255	305	335	329	329	329	379	439	438	478
B	50	55	60	70	80	80	90	110	110	110
C	126	142	150	185	185	220	220	240	240	240
D	225	275	305	300	300	300	350	400	400	440
E	240	290	320	314	314	314	364	414	413	453
F	25	30	35	45	55	55	65	80	80	80
G	6.5	6.5	6.5	6.5	6.5	6.5	6.5	6.5	6.5	6.5
H	1	1	1	1.5	1.5	1.5	1.5	3	4	4
I	10.9	10.9	25	25	39	39	45	45	51	51
J	M5	M5	M5	M6	M6	M6	M10	M10	M10	M10
K	25	27.5	30	35	40	40	45	55	55	55
L	85	100	110	130	105	140	130	140	110	110
X*	AWG 16	AWG 14	AWG 10	AWG 8	AWG 6				50 mm ²	70 mm ²
Y*	300 ±10	300 ±10	400 ±10	500 ±10	500 ±10				500 ±10	500 ±10
Z*	9	9	9	12	12				15	15

* Filters with output wire connections (-07) only.

All dimensions in mm; 1 inch = 25.4 mm

Tolerances according: ISO 2768-m/EN 22768-m

Filter input/output connector cross sections

	-29	-33	-34	-35	-40
					
Solid wire	6 mm ²	16 mm ²	35 mm ²	50 mm ²	95 mm ²
Flex wire	4 mm ²	10 mm ²	25 mm ²	50 mm ²	95 mm ²
AWG type wire	AWG 10	AWG 6	AWG 2	AWG 1/0	AWG 4/0
Recommended torque	0.6-0.8 Nm	1.5-1.8 Nm	4.0-4.5 Nm	7-8 Nm	17-20 Nm

Please visit www.schaffner.com to find more details on filter connectors.

