

NM1 series moulded case circuit breaker

Application

The breaker is mainly used in distribution network of AC 50Hz/60Hz, rated voltage up to 690V, rated working current up to 630A to distribute electric power and to protect the line and the equipment from being damaged due to overload, short current and under-voltage. It can also be used for infrequent motor start and for motor overload, short circuit and under-voltage protections. The breaker can be installed vertically or horizontally. The product is in conformity with the standards IEC60947-2 and GB14048.2.

Model meaning

Model meaning

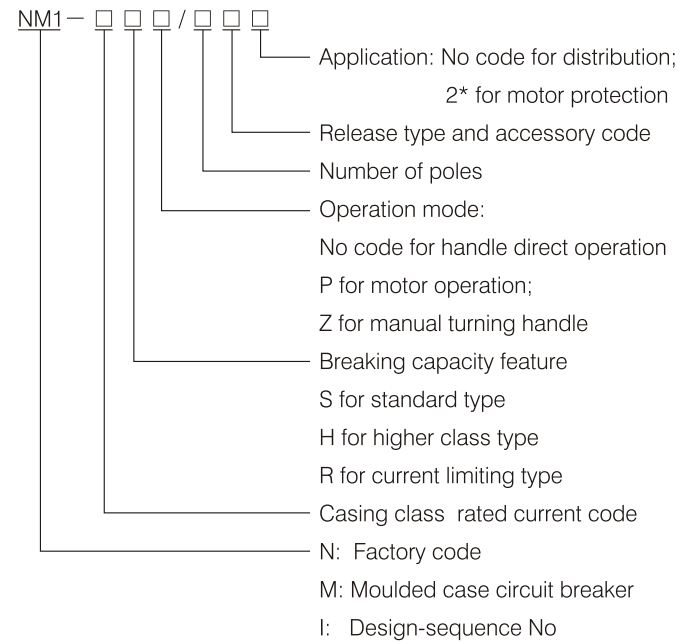

Classification

According to breaking capacity of breaker:

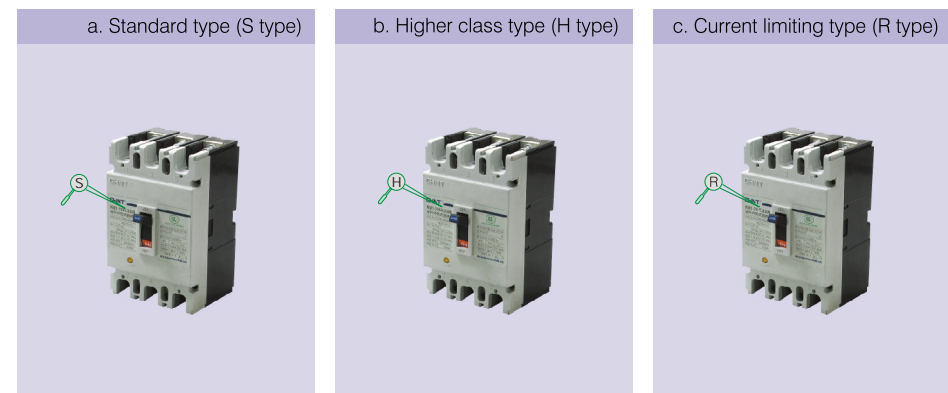

According to wiring mode:

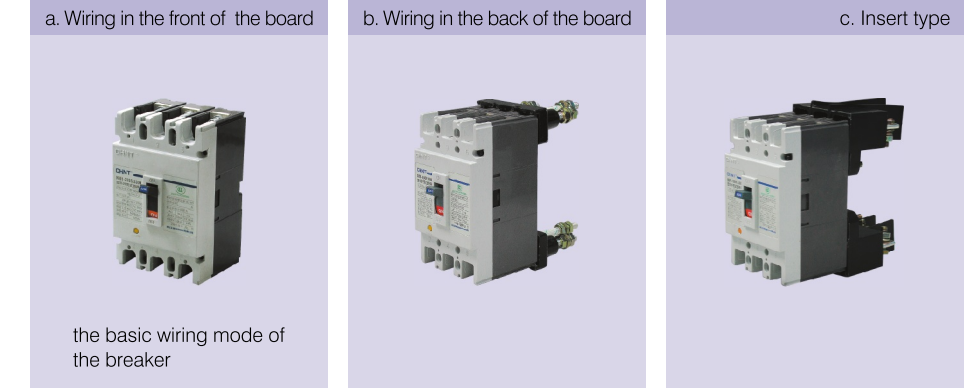

According to operation mode:

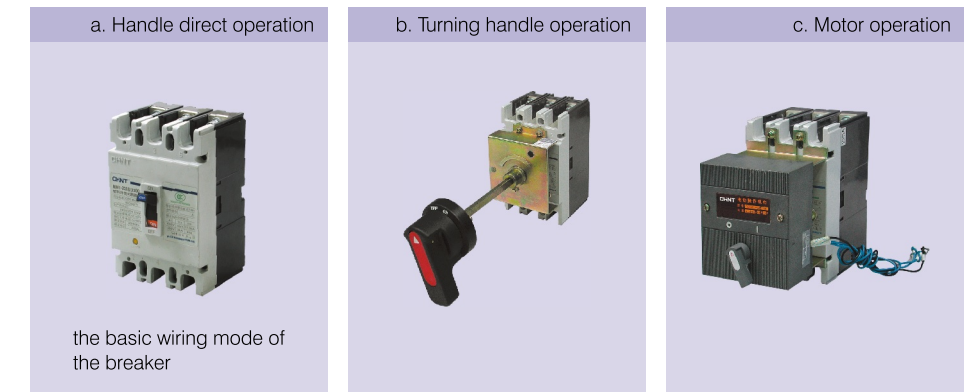

According to number of poles:

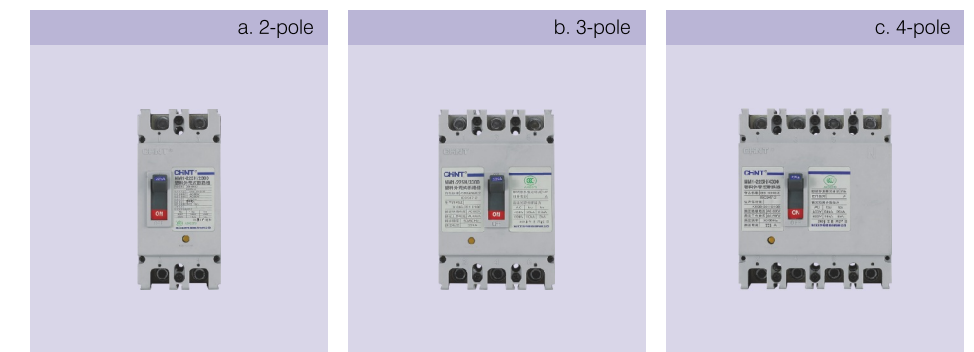

Working condition

Environmental temperature

The upper limit of the environmental temperature is +40°C.

The lower limit of the temperature is 5°C.

The average temperature in 24 hours shall not exceed +35°C.

Altitude: The altitude of the installation place shall not exceed 2000m.











Pollution grade: Grade III

Atmosphere condition:











The relative humidity shall not exceed 50% when the environmental temperature is +40°C.

The relative humidity may be higher at the lower temperature condition. The maximum month-average relative humidity is 90% in the most humid month with a minimum month-average temperature +25°C. The factor that dew may occur on the product surface due to temperature change shall be taken into consideration.



Main technical parameter

Model	NM1-63S/3P	NM1-63H/3P	NM1-63H/4P	NM1-100S/3P	NM1-100H/2P	NM1-100H/3P	NM1-100H/4P	NM1-100R/3P	NM1-225S/3P	NM1-225H/2P																						
Picture																																
Casing class rated current(A)	63	63	63	100	100	100	100	100	225	225																						
Rated current (A)	10, 16, 20, 32, 40, 50, 63	10, 16, 20, 32, 40, 50, 63	10, 16, 20, 32, 40, 50, 63	16, 20, 32, 40, 50, 63, 80, 100	16, 20, 32, 40, 50, 63, 80, 100	16, 20, 32, 40, 50, 63, 80, 100	16, 20, 32, 40, 50, 63, 80, 100	16, 20, 32, 40, 50, 63, 80, 100	100, 125, 160, 180, 200, 225	100, 125, 160, 180, 200, 225																						
Rated operation voltage (V)	400	400	400	690	690	690	690	690	690	690																						
Rated insulation voltage (V)	500	500	500	800	800	800	800	800	800	800																						
Rated ultimate short circuit breaking capacity(kA) 400V/690V	15*	35*	35*	30/2	50/5	50/5	50/5	65/8	30/2	50/5																						
Rated operation short circuit breaking capacity (kA) 400V/690V	7.5*	17.5*	17.5*	15/1	25/2.5	25/2.5	25/2.5	32.5/4	15/1	25/2.5																						
Arcing distance (mm)	≤50	≤50	≤50	≤50	≤50	≤50	≤50	≤50	≤50	≤50																						
Application	<table border="0"> <tr> <td>Power distribution</td> <td>●</td><td>●</td><td>●</td><td>●</td><td>●</td><td>●</td><td>●</td><td>●</td><td>●</td><td>●</td> </tr> <tr> <td>Motor protection</td> <td>●</td><td>●</td><td>—</td><td>●</td><td>—</td><td>●</td><td>—</td><td>●</td><td>●</td><td>—</td> </tr> </table>										Power distribution	●	●	●	●	●	●	●	●	●	●	Motor protection	●	●	—	●	—	●	—	●	●	—
Power distribution	●	●	●	●	●	●	●	●	●	●																						
Motor protection	●	●	—	●	—	●	—	●	●	—																						

Note: 1, * stand for test parameter at 400V 2, 6A without thermal release

Model	NM1-225H/3P	NM1-225H/4P	NM1-225R/3P	NM1-400S/3P	NM1-400S/4P	NM1-400H/3P	NM1-400R/3P	NM1-630S/3P	NM1-630S/4P	NM1-630H/3P																						
Picture																																
Casing class rated current(A)	225	225	225	400	400	400	400	630	630	630																						
Rated current (A)	100, 125, 160, 180, 200, 225	100, 125, 160, 180, 200, 225	100, 125, 160, 180, 200, 225	225, 250, 315, 350, 400	225, 250, 315, 350, 400	225, 250, 315, 350, 400	225, 250, 315, 350, 400	400, 500, 630	400, 500, 630	400, 500, 630																						
Rated operation voltage (V)	690	690	690	690	690	690	690	690	690	690																						
Rated insulation voltage (V)	800	800	800	800	800	800	800	800	800	800																						
Rated ultimate short circuit breaking capacity(kA) 400V/690V	50/5	50/5	65/8	40/5	40/5	55/8	70/10	40/5	40/5	55/8																						
Rated operation short circuit breaking capacity (kA) 400V/690V	25/2.5	25/2.5	32.5/4	20/2.5	20/2.5	27.5/4	35/5	20/2.5	20/2.5	27.5/4																						
Arcing distance (mm)	≤50	≤50	≤50	≤100	≤100	≤100	≤100	≤100	≤100	≤100																						
Application	<table border="0"> <tr> <td>Use for power distribution</td> <td>●</td><td>●</td><td>●</td><td>●</td><td>●</td><td>●</td><td>●</td><td>●</td><td>●</td><td>●</td> </tr> <tr> <td>Use for motor protection</td> <td>●</td><td>—</td><td>●</td><td>●</td><td>—</td><td>●</td><td>●</td><td>●</td><td>—</td><td>●</td> </tr> </table>										Use for power distribution	●	●	●	●	●	●	●	●	●	●	Use for motor protection	●	—	●	●	—	●	●	●	—	●
Use for power distribution	●	●	●	●	●	●	●	●	●	●																						
Use for motor protection	●	—	●	●	—	●	●	●	—	●																						

The rated value of the breaker

Model	NM1-630R/3P	NM1-800H/3P	NM1-800R/3P
Picture			
Casing class rated current(A)	630	800	800
Rated current (A)	400, 500, 630	630, 700, 800	630, 700, 800
Rated operation voltage (V)	690	690	690
Rated insulation voltage (V)	800	800	800
Rated ultimate short circuit breaking capacity(kA) 400V/690V	70/10	60*	70*
Rated operation short circuit breaking capacity (kA) 400V/690V	35/5	30*	35*
Arcing distance (mm)	≤100	≤100	≤100
Application	Use for power distribution ● Use for motor protection ●	● ●	● ●

Note: * stand for test parameter at 400V

Inverse time switch-off action property of the over current tripping gear of the breaker (used for power distribution) at the status that all poles are energized simultaneously

No.	Test current	I/In	Specified time	Initial status
1	Specified no-trip current	1.05	2h(In>63A), 1h(In≤63A)	Cold position
2	Specified trip current	1.30	2h(In>63A), 1h(In≤63A)	Following the test no. 1

Inverse time-lag switch-off action property of the over current tripping gear of the breaker (used for motor protection) at the status that all poles are energized simultaneously

No.	Rated current	Specified time	Initial status
1	1.0In	>2h	Cold position
2	1.2In	≤2h	Following the test no. 1
3	1.5In	≤4min	Hot position
4	7.2In	4s≤T≤10s	Cold position



The neutral pole of breaker(4P) is on the right side of the breaker, the rated current of the breaker C and D type with the neutral pole

Casing class current of the breaker	Rated current of the breaker	Rated current with neutral of the breaker
100	16	16
100	20	20
100	32	32
100	40	40
100	50	50
100	63	63
100	80	63
100	100	63
225	100	100
225	125	100
225	160	100
225	180	100
225	200	100
225	225	125
400	225	225
400	250	225
400	315	225
400	350	250
400	400	250
630	400	250
630	500	315
630	630	350

Inverse time protection performance curve of the breaker (for power distribution)

Curve of action feature

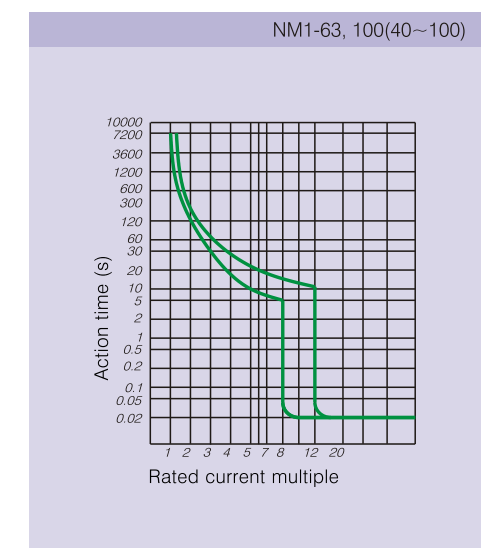
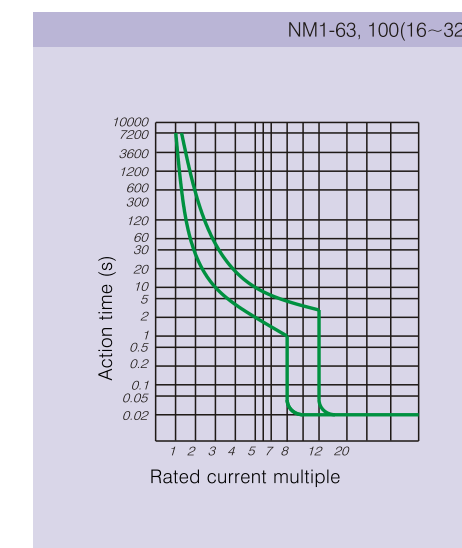

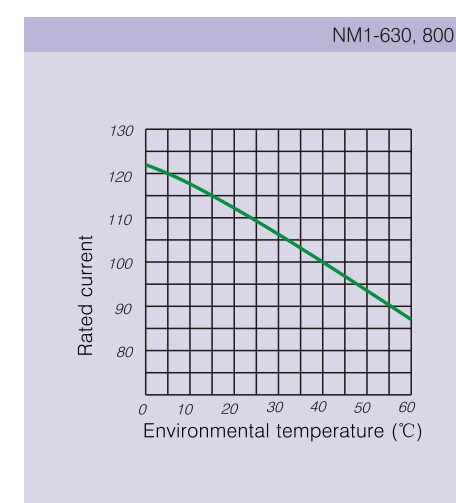
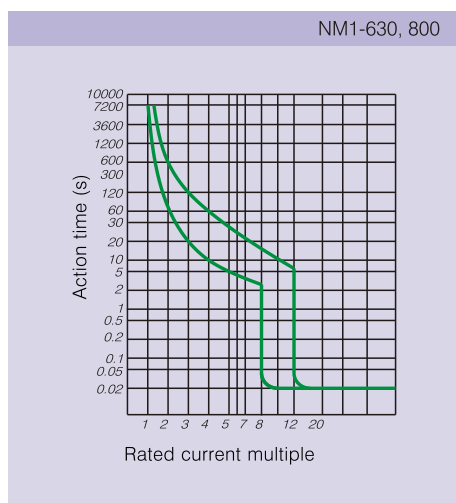
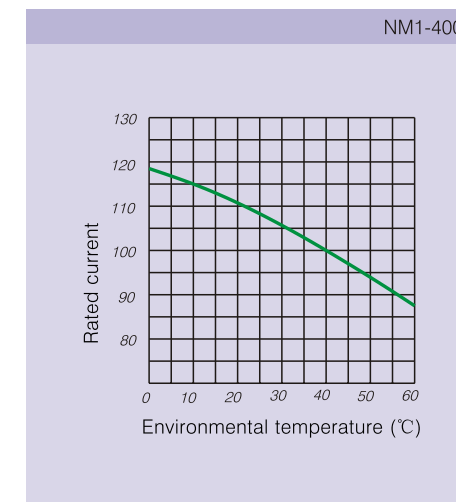
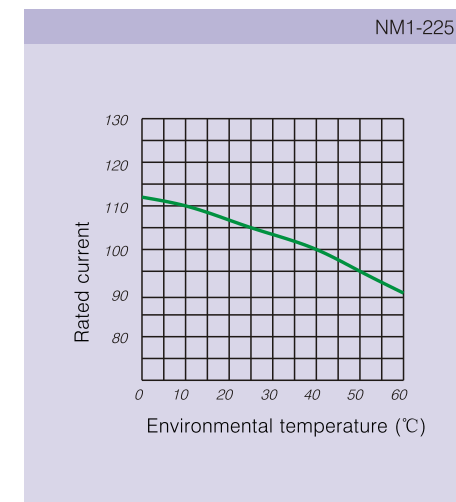
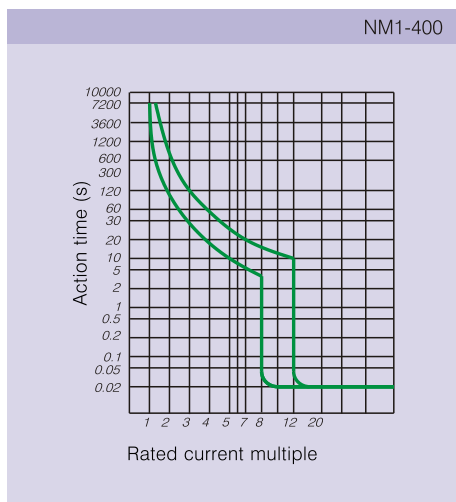
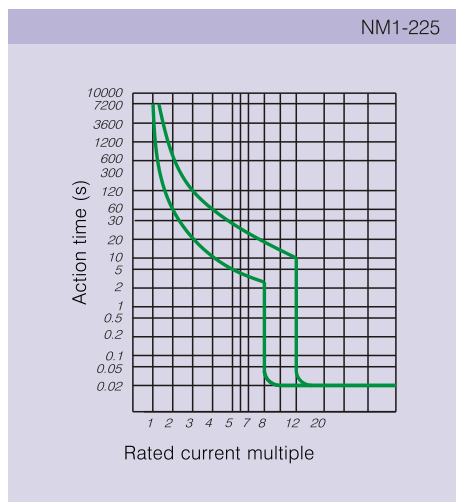

Temperature correction curve

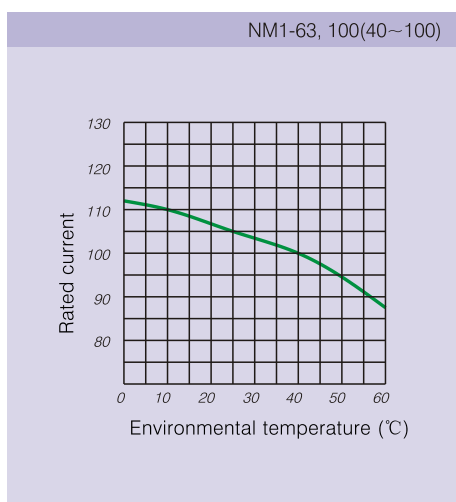
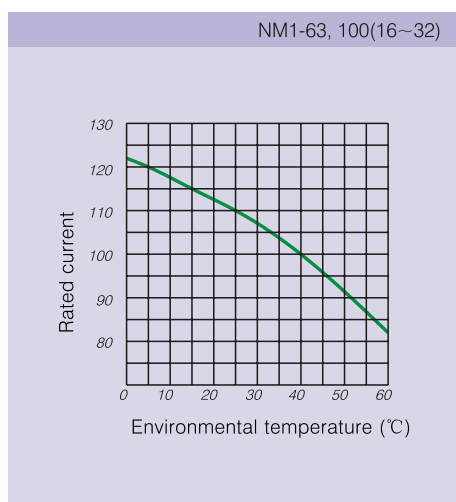

Inner accessories

Under-voltage release

The under-voltage release shall act to switch off the breaker when the power voltage decreases (even if slowly decreases) to 70%~35% rated voltage. It shall prevent the breaker from re-closing, if the power voltage decreases to less than 35% rated voltage. It shall ensure to close the breaker, if the power voltage is equal to or greater than 85% rated voltage.

The rated voltage of the under-voltage release is 50Hz, 230V and 400V.

Code of under-voltage release

code	A2	A4	D1	D2
voltage	AC 230V	AC 400V	DC 110V	DC 230V
rated frequency	50Hz	50Hz	—	—

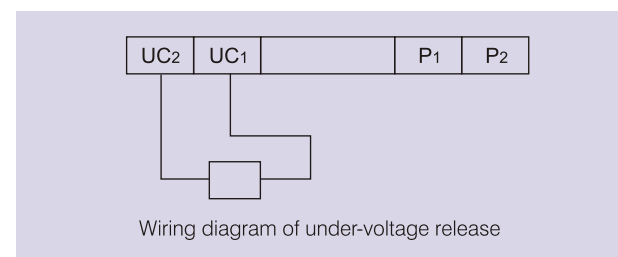

Shunt release

The rated control voltage of the shunt release is 50Hz, 230V and 400V.

The breaker shall be reliably switched off under 70%~110% rated voltage.

Code of shunt release

code	A2	A4	D1	D2	D3
voltage	AC 230V	AC 400V	DC 110V	DC 230V	DC 24V
rated frequency	50HZ	50HZ	-	-	-

Note: when voltage is DC 24V, rated current up to 5A±10%

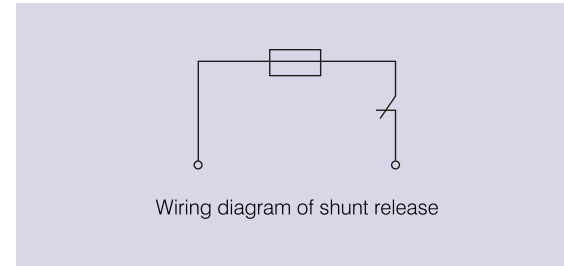

Auxiliary contacts

Rated parameter of auxiliary contact

Casing class	Conventional heating current Ith A	Rated current Ie A at AC 400 V	Rated current Ie A at DC 230 V
I _{nm} ≤ 225A	3	0.26	0.14
I _{nm} ≥ 400A	6	3	0.2

The status of auxiliary contact

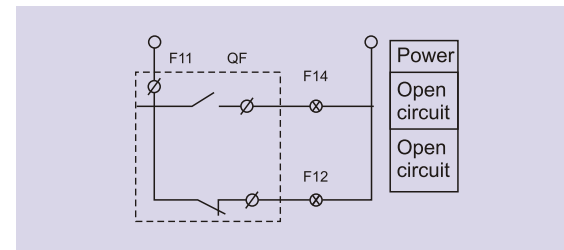
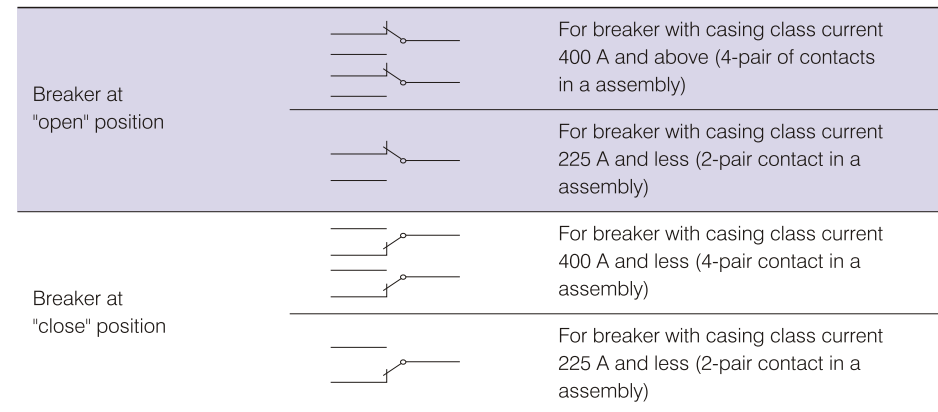

Alarm contact

The alarm contact does not act when the relay is at normal open/close status. Only after free release alarm (or fault release), can the contact change its original position, i.e. normal open



becomes close, or normal close becomes open. After the breaker closes again, the alarm contact recovers to its original status.

The status of auxiliary contact

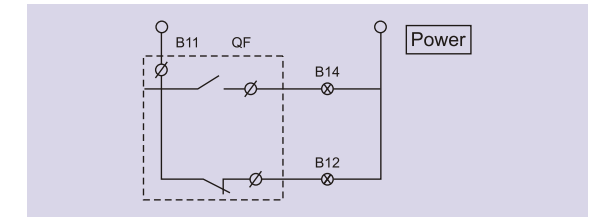
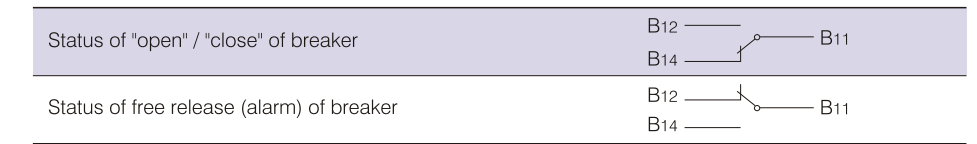

Installation of inner accessories and wiring mode

Release mode / Accessory code	Code of accessory		Installation of accessories and wiring mode			
	Electromagnet release	Compound release	NM1-63S, H NM1-100S, H, R NM1-225S, H, R	NM1-400S NM1-630	NM1-400H	NM1-630H NM1-800
			3P, 4P	3P, 4P	3P	4P
No accessory	200	300				
Alarm contact	208	308				
Shunt release	210	310				
Auxiliary contact	220	320				
Under-voltage release	230	330				
Shunt release, auxiliary contact	240	340				
Shunt release, under-voltage release	250	350				
Two sets of auxiliary contact	260	360				
Auxiliary contact, under-voltage release	270	370				
Shunt release, alarm contact	218	318				
Auxiliary contact, alarm contact	228	328				
Under-voltage release, alarm contact	238	338				
Shunt release, auxiliary contact, alarm contact	248	348				
Two sets of auxiliary contact, alarm contact	268	368				
Auxiliary contact, under-voltage release, alarm contact	278	378				

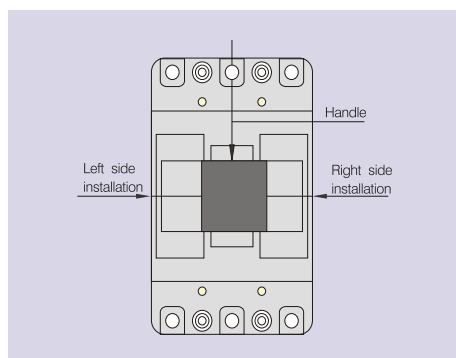

Outer accessories

Electromagnet operation mechanism (NM1-63, 100, 225)

Type	NM1-63, NM1-100, NM1-225
Model	
Structure form	Electromagnet
Code of AV voltage	A2, A4
Code of DC voltage	D1, D2

Open/close wiring diagram of electromagnet operation

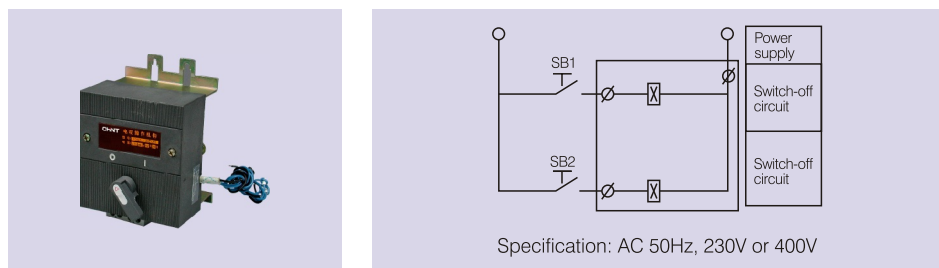

Motor operation mechanism (NM1-400, 630)

Type	NM1-400, NM1-630
Model	
Structure form	Motor
Code of AV voltage	A2, A4
Code of DC voltage	D1, D2

Open / close wiring diagram of motor operation

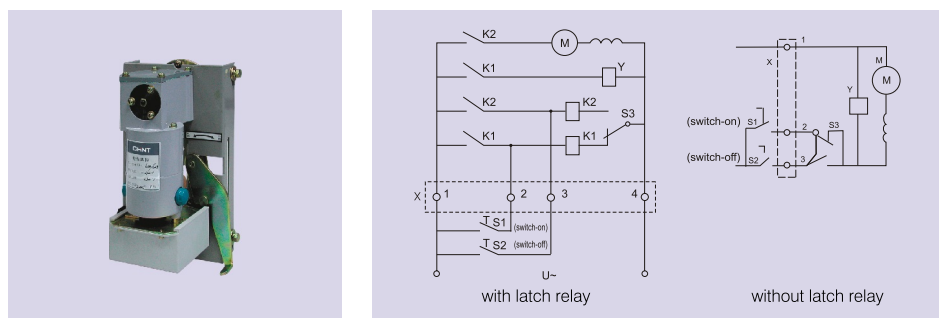

S1, S2 operation button (prepared by user)
X wiring terminal
K1, K2 latchrelay S3 inching switch
M special series motor Y brake electromagnet



Turning handle operation mechanism

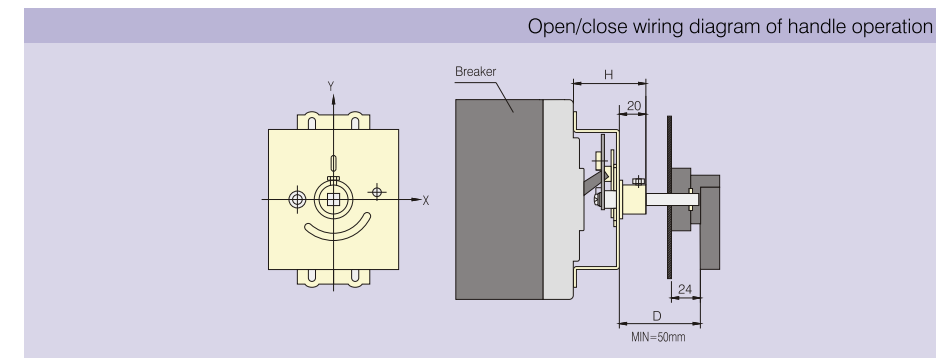

Type	NM1-63	NM1-100	NM1-225	NM1-400S	NM1-400H NM1-400R	NM1-630S	NM1-630R NM1-800H NM1-800R
Installation size	49	54	54	84	76	83	76
Y value of the handle related to the center of the breaker	0	0	0	0	-10	0	-20

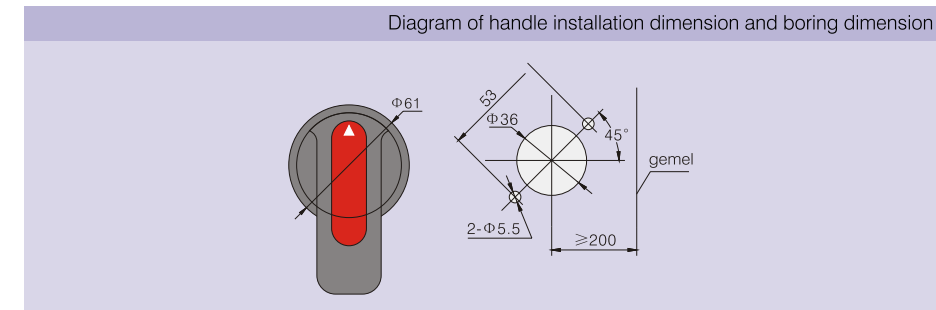

Mechanical interlocking

Type	A	B	C	D	E	F	L	Φd
NM1-63								
NM1-100	30	129	90	30	90	155	210	4.5×6*
NM1-225	35	126	100	30	100	165	240	5.5
NM1-400	44	194	172	20	62	257	330	7
NM1-630	58	200	175	48	62	270	412	7
NM1-800								

Note: 1, * stands for hole length
2, install the breaker on the frame first, then install the mechanical interlocking on the breaker.

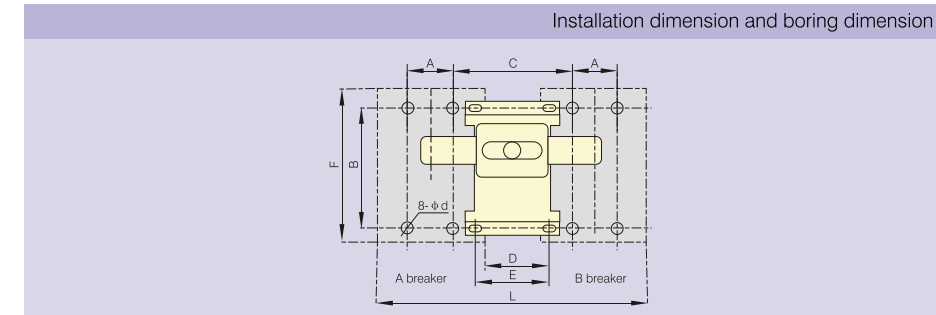

Installation dimension and outline dimension

NM1-63, 100, 225 (wiring in the front of the board)

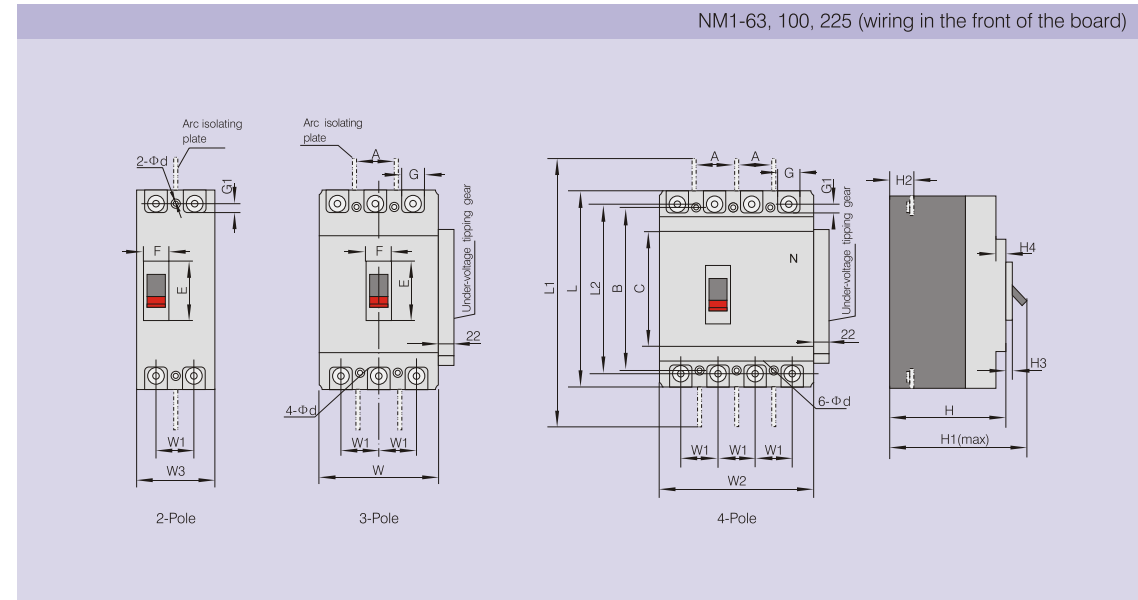

		Model					
		NM1-63S	NM1-63H	NM1-100S	NM1-100H NM1-100R	NM1-225S	NM1-225H NM1-225R
Outline dimension	C	85	85	84	84	102	102
	E	48	48	50	50	50	50
	F	22	22	22	22	22	22
	G	14	14	17	17	23	23
	G1						
	H	73	81	68	86	86	103
	H1	90	98.5	86	102	110	127
	H2	20	27	24	24	24	24
	H3	4.5	4.5	4	4	4	4
	H4	7	7	7	7	5	5
	L	135	135	155	155	165	165
	L1	170	173	255	255	360	360
	L2	117	117	136	136	144	144
W	76	76	90	90	105	105	
W1	25	25	30	30	35	35	
W2		101	---	120	---	140	
W3		---	---	64.5	---	74.5	
Installation dimension	A	25	25	30	30	35	35
	B	117	117	129	129	126	126
	Φd	3.5	3.5	4.5×6	4.5×6	5.5	5.5

NM1-400, 630, 800 (wiring in the front of the board)

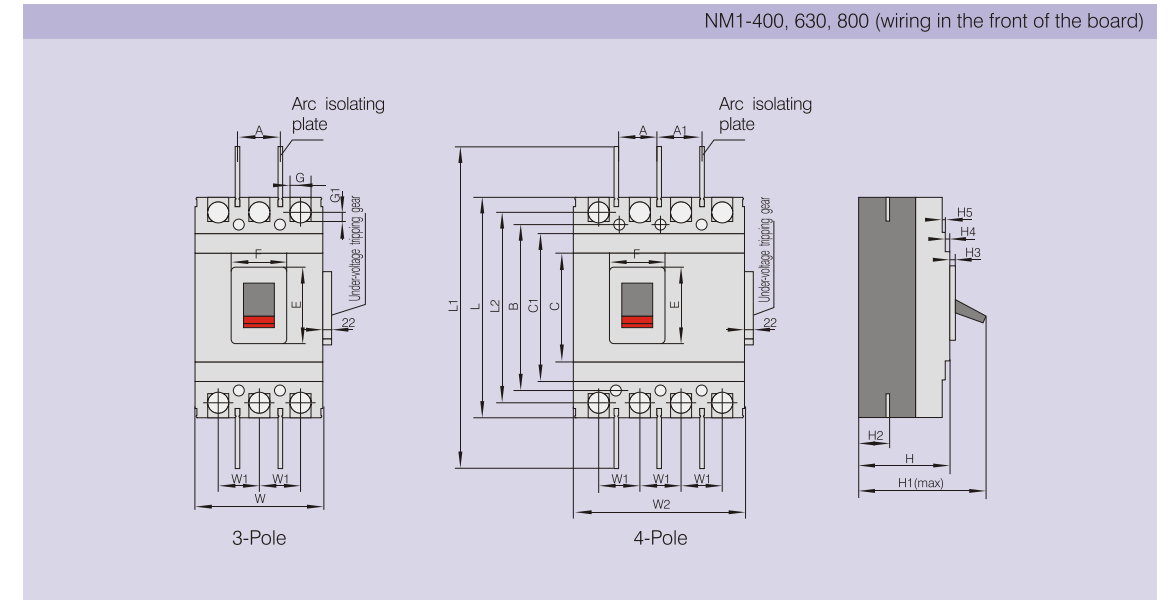

		Model				
		NM1-400S	NM1-400H NM1-400R	NM1-630S	NM1-630H	NM1-630R NM1-800H/R
Outline dimension	C	102	129	134	134	155
	C1	179	175	184	184	205
	E	90	89	89	89	106
	F	62	65	65	65	66
	G	29.5	32.5	44	44	44
	H	104	107	111	111	107
	H1	155	150	160	160	148
	H2	38	39	44	44	33
	H3	6	6	6.5	6.5	4.5
	H4	6	4.5	3.5	3.5	4.5
	H5	2.5	4.5	4.5	4.5	8
	L	258	257	270	270	280
	L1	457	457	470	470	470
L2	225	225	234	234	243	
W	140	150	182	182	210	
W1	44	48	58	58	70	
W2	198	---	240	---	---	
Installation dimension	A	44	44	58	58	70
	A1	50	---	58	---	---
	B	194	194	200	200	243
	Φd	7	7	7	7	7

Wiring at back of the board

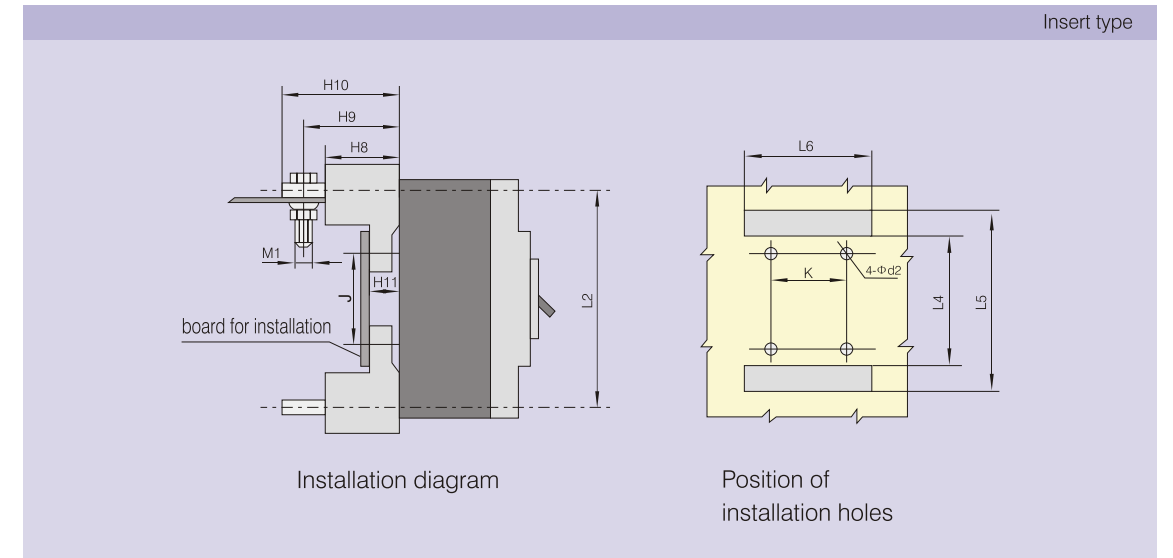
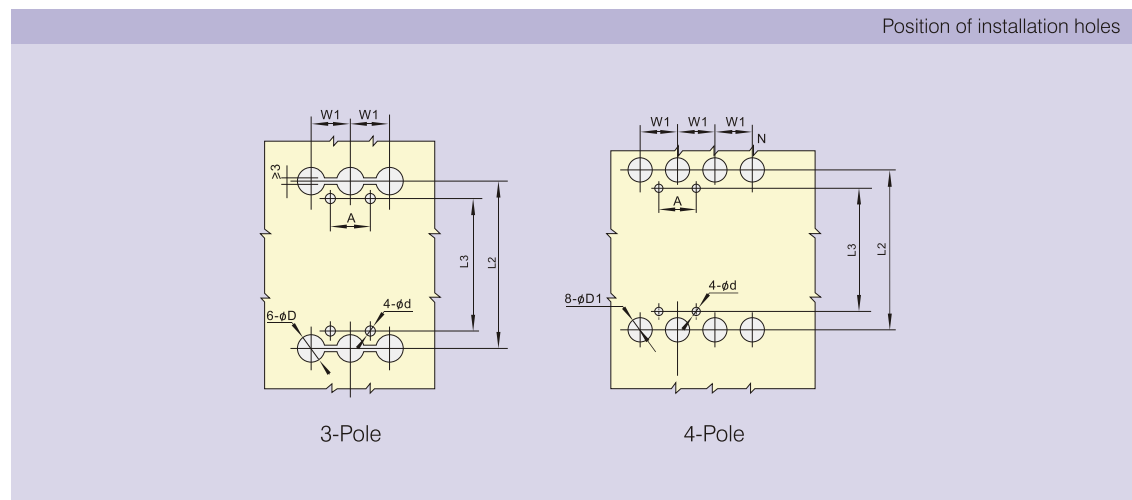
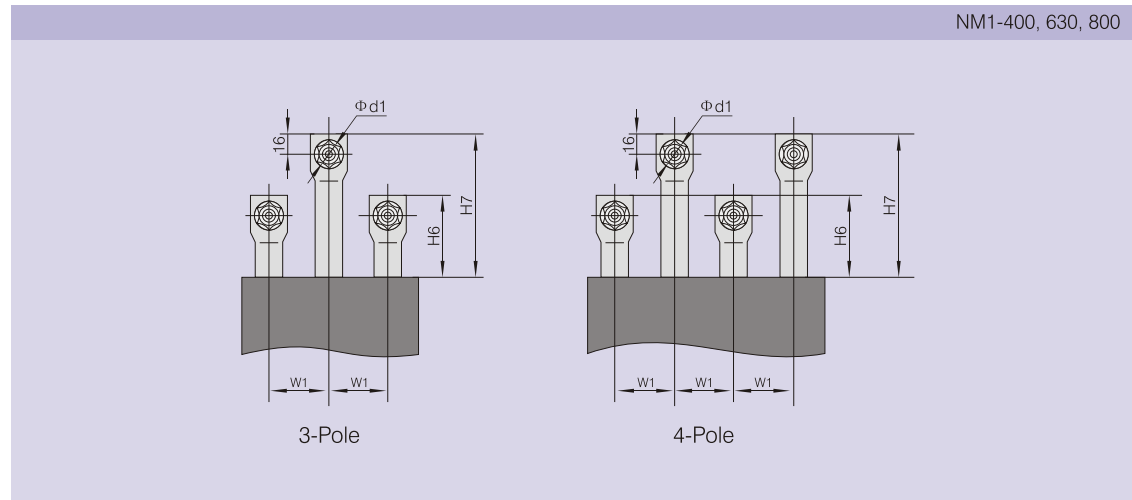
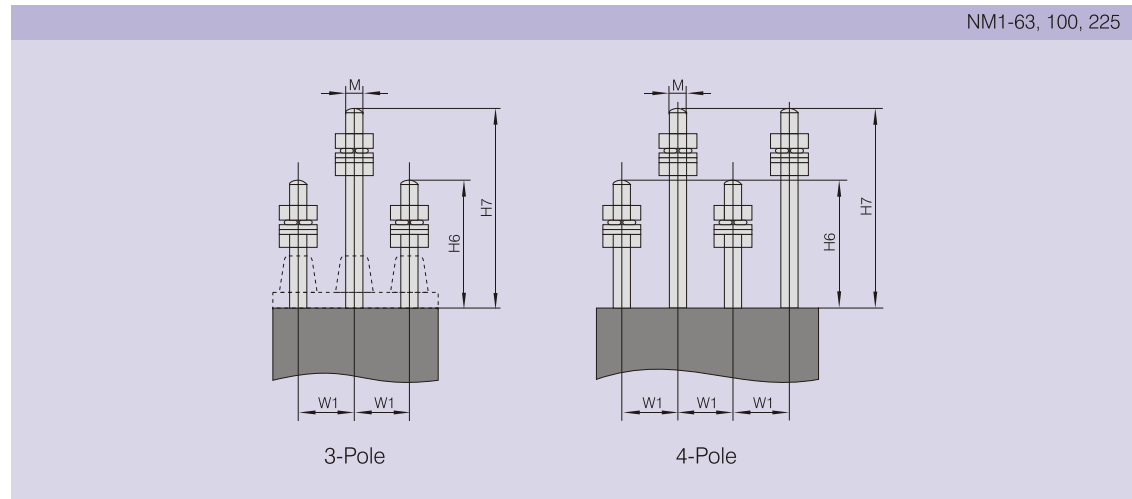

	Model						
	NM1-63S	NM1-100S	NM1-225S	NM1-400S	NM1-400H	NM1-630S	NM1-630R
	NM1-63H	NM1-100HR	NM1-225H NM1-225R		NM1-400R	NM1-630H	NM1-800H NM1-800R
A	25	30	35	44	44	58	70
Φd	3.5	4.5 × 6 (hole length)	5.5	7	7	7	7
Φd1							
Φd2	6	8	8	8.5	9	8.5	12
ΦD	8	24	26	31	33	37	37
ΦD1	8	16	20	33	37	37	37
H6	44	68	66	60	65	65	48
H7	66	108	110	120	120	125	125
H8	28	51	51	61	60	60	87
H9	38	65.5	72	---	83.5	93	---
H10	44	78	91	99	106.5	112	106
H11	8.5	17.5	17.5	22	21	21	26.5
L2	117	136	144	225	225	234	243
L3	117	108	124	194	194	200	243
L4	97	95	90	165	163	165	173
L5	138	180	190	285	285	302	305
L6	80	95	110	145	155	185	215
W1	50	60	70	87	96	111	140

Outline dimension of wiring at back of the board