

Pushbuttons—Non-Illuminated and Illuminated



Contents

<i>Description</i>	<i>Page</i>
Pushbuttons—Non-Illuminated and Illuminated	
Non-Illuminated, Flush, Momentary	36
Non-Illuminated, Flush, Maintained	39
Non-Illuminated, Extended, Momentary	41
Non-Illuminated, Extended, Maintained	43
Illuminated, Flush, Momentary	46
Illuminated, Flush, Maintained	49
Illuminated, Extended, Momentary	51
Illuminated, Extended, Maintained	53

Pushbuttons—Non-Illuminated and Illuminated

Product Description

Eaton’s M22 pushbutton line is a complete, modular and versatile offering. From field-convertible maintained operators to customizable laser engraved buttons, the M22 pushbutton line provides endless opportunity for flexibility and reduced inventory. Each operator type provides options for ordering as complete or component parts allowing for a perfect fit for each application. All of this flexibility comes in a very rugged design.

Features

- Field convertible from maintained to momentary (available on maintained pushbuttons only)
- Customizable laser engraving on all buttons
- LED offering only for improved brightness quality and up to 100,000 hours of operation
- More than five million mechanical operations on momentary and 1 million on maintained pushbuttons
- Modular construction makes assembly fast and simplifies stocking of components and complete devices
- Capable of communicating via ASi protocol with ASi adapter modules

Protection Type

- IP67, IP69K
- NEMA 4X, 13

47.4 Pushbuttons and Indicating Lights

22.5 mm Modular Pushbuttons—M22

Catalog Number Selection

Catalog Number Selection is for illustrative purposes only and not to be used to create new catalog numbers.

Non-Illuminated Pushbuttons

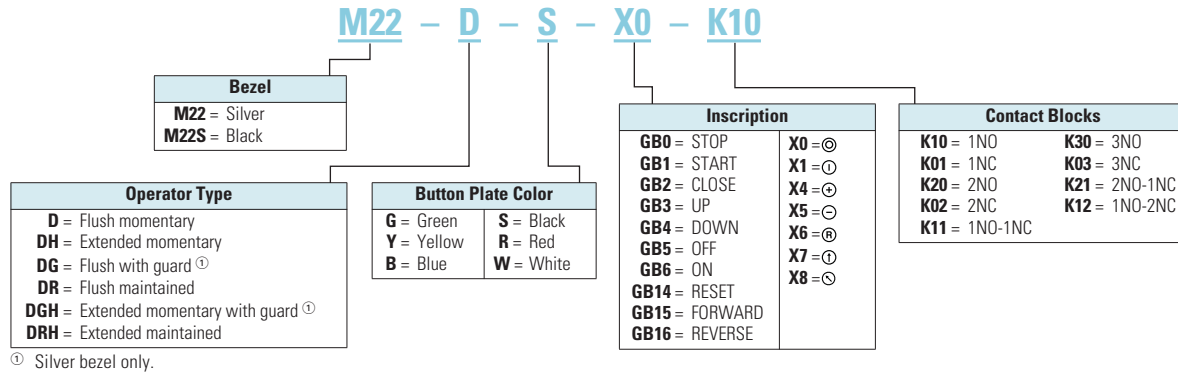

Product Selection

Non-Illuminated Pushbuttons, Flush, Momentary

Complete Devices

	Bezel	Button Color	Contact Block Configuration ^①	Catalog Number
	Silver	Black	NO	M22-D-S-K10
			NC	M22-D-S-K01
			2NO	M22-D-S-K20
			2NC	M22-D-S-K02
			1NO-1NC	M22-D-S-K11
		Red	NO	M22-D-R-K10
			NC	M22-D-R-K01
			2NO	M22-D-R-K20
			2NC	M22-D-R-K02
			1NO-1NC	M22-D-R-K11
			Green	NO
		NC		M22-D-G-K01
2NO	M22-D-G-K20			
2NC	M22-D-G-K02			
1NO-1NC	M22-D-G-K11			
	Black	Black	NO	M22S-D-S-K10
			NC	M22S-D-S-K01
			2NO	M22S-D-S-K20
			2NC	M22S-D-S-K02
			1NO-1NC	M22S-D-S-K11
		Red	NO	M22S-D-R-K10
			NC	M22S-D-R-K01
			2NO	M22S-D-R-K20
			2NC	M22S-D-R-K02
			1NO-1NC	M22S-D-R-K11
			Green	NO
		NC		M22S-D-G-K01
2NO	M22S-D-G-K20			
2NC	M22S-D-G-K02			
1NO-1NC	M22S-D-G-K11			

Note

^① All NC contact blocks are positively driven contact. ⊖

Non-Illuminated Pushbuttons, Flush, Momentary

Operators Only ^①

	Bezel	Button Color	Inscription	Catalog Number
M22-D-G 	Silver	Black	—	M22-D-S
		Red	—	M22-D-R
			STOP	M22-D-R-GB0
			⊙	M22-D-R-X0
		Green	—	M22-D-G
			START	M22-D-G-GB1
			⓪	M22-D-G-X1
		White	—	M22-D-W
		Blue	—	M22-D-B
		Yellow	—	M22-D-Y
		—	—	M22-D-X-SRG ^②
		—	—	M22-D-X-SWRGYB ^③
		M22S-D-G 	Black	Black
Red	—			M22S-D-R
	STOP			M22S-D-R-GB0
	⊙			M22S-D-R-X0
Green	—			M22S-D-G
	START			M22S-D-G-GB1
	⓪			M22S-D-G-X1
White	—			M22S-D-W
Blue	—			M22S-D-B
Yellow	—			M22S-D-Y
—	—			M22S-D-X-SRG ^②
—	—			M22S-D-X-SWRGYB ^③
M22-DG-G 	Silver guarded			Black
		Red	—	M22-DG-R
		Green	—	M22-DG-G
		White	—	M22-DG-W
		Blue	—	M22-DG-B
		Yellow	—	M22-DG-Y
		—	—	M22-DG-X-SRG ^②
		—	—	M22-DG-X-SWRGYB ^③

Notes

- ① Includes contact block mounting adapter.
- ② Buttonless operator comes with three color buttons (black, red, green).
- ③ Buttonless operator comes with all six color buttons (black, white, red, green, yellow, blue).

Non-Illuminated Pushbuttons, Flush, Maintained ^①

Operators Only ^②

M22-DR-S



Bezel	Button Color	Catalog Number
Silver	Black	M22-DR-S
	Red	M22-DR-R
	Green	M22-DR-G
	White	M22-DR-W
	Blue	M22-DR-B
	Yellow	M22-DR-Y
	③	M22-DR-X-SRG
	④	M22-DR-X-SWRGYB
Black	Black	M22S-DR-S
	Red	M22S-DR-R
	Green	M22S-DR-G
	White	M22S-DR-W
	Blue	M22S-DR-B
	Yellow	M22S-DR-Y
	③	M22S-DR-X-SRG
	④	M22S-DR-X-SWRGYB

M22S-DR-S



Notes

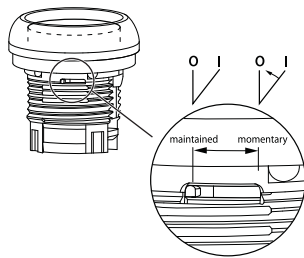

- ① Maintained pushbuttons can be converted in the field to momentary operation by switching the locking ring, which is accessible through the side of the operator body.
- ② Includes contact block mounting adapter.
- ③ Buttonless operator comes with three color buttons (black, red, green).
- ④ Buttonless operator comes with all six color buttons (black, white, red, green, yellow, blue).





Note: This pilot device features a selectable function switch that enables the device to be set to either maintained or momentary operation.

Non-Illuminated Pushbuttons, Extended, Momentary

Complete Devices

	Bezel	Button Color	Contact Block Configuration ①	Catalog Number
 <p>M22-DH-R-K10</p>	Silver	Red	NO	M22-DH-R-K10
			NC	M22-DH-R-K01
			2NO	M22-DH-R-K20
			2NC	M22-DH-R-K02
			1NO-1NC	M22-DH-R-K11
 <p>M22S-DH-R-K10</p>	Black	Red	NO	M22S-DH-R-K10
			NC	M22S-DH-R-K01
			2NO	M22S-DH-R-K20
			2NC	M22S-DH-R-K02
			1NO-1NC	M22S-DH-R-K11
 <p>M22-DGH-R-K10</p>	Silver guarded	Red	NO	M22-DGH-R-K10
			NC	M22-DGH-R-K01
			2NO	M22-DGH-R-K20
			2NC	M22-DGH-R-K02
			1NO-1NC	M22-DGH-R-K11

Operators Only ②



	Bezel	Button Color	Inscription	Catalog Number
 <p>M22-DH-R</p>	Silver	Black	—	M22-DH-S
		Red	—	M22-DH-R
			STOP	M22-DH-R-GB0
			⊙	M22-DH-R-X0
		Green	—	M22-DH-G
		White	—	M22-DH-W
		Blue	—	M22-DH-B
		Yellow	—	M22-DH-Y
		③	—	M22-DH-X-SRG
		④	—	M22-DH-X-SWRGYB
		 <p>M22S-DH-R</p>	Black	Black
Red	—			M22S-DH-R
	STOP			M22S-DH-R-GB0
	⊙			M22S-DH-R-X0
Green	—			M22S-DH-G
White	—			M22S-DH-W
Blue	—			M22S-DH-B
Yellow	—			M22S-DH-Y
③	—			M22S-DH-X-SRG
④	—			M22S-DH-X-SWRGYB
 <p>M22-DGH-R</p>	Silver guarded			Black
		Red	—	M22-DGH-R
			STOP	M22-DGH-R-GB0
			⊙	M22-DGH-R-X0
		Green	—	M22-DGH-G
		White	—	M22-DGH-W
		Blue	—	M22-DGH-B
		Yellow	—	M22-DGH-Y

Notes

- ① All NC contact blocks are positively driven contact. ⊖
- ② Includes contact block mounting adapter.
- ③ Buttonless operator comes with three color buttons (black, red, green).
- ④ Buttonless operator comes with all six color buttons (black, white, red, green, yellow, blue).

Non-Illuminated Pushbuttons, Extended, Maintained^①

Operators Only^②

	Bezel	Button Color	Catalog Number
M22-DRH-W 	Silver	Black	M22-DRH-S
		Red	M22-DRH-R
		Green	M22-DRH-G
		White	M22-DRH-W
		Blue	M22-DRH-B
		Yellow	M22-DRH-Y
		③	M22-DRH-X-SRG
M22S-DRH-W 	Black	Black	M22S-DRH-S
		Red	M22S-DRH-R
		Green	M22S-DRH-G
		White	M22S-DRH-W
		Blue	M22S-DRH-B
		Yellow	M22S-DRH-Y
		③	M22S-DRH-X-SRG
④	M22S-DRH-X-SWRGYB		

Notes

- ① Maintained pushbuttons can be converted in the field to momentary operation by switching the locking ring, which is accessible through the side of the operator body.
- ② Includes contact block mounting adapter.
- ③ Buttonless operator comes with three color buttons (black, red, green).
- ④ Buttonless operator comes with all six color buttons (black, white, red, green, yellow, blue).

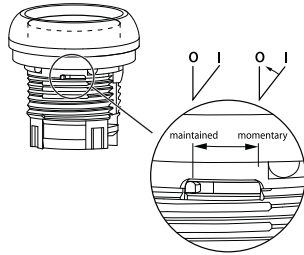

Note: This pilot device features a selectable function switch that enables the device to be set to either maintained or momentary operation.