

SLSE30-750Q5

– Emitter

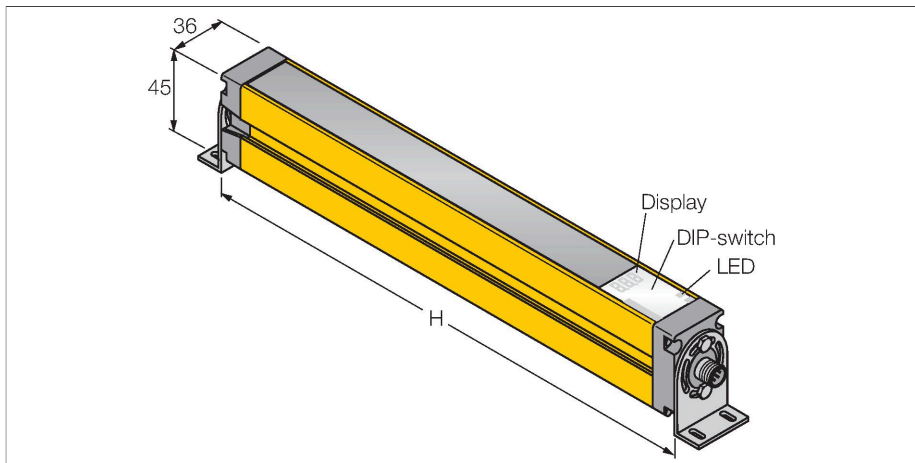

Technical data

Type	SLSE30-750Q5
ID	3071240
Optical data	
Function	Light screen
Light type	IR
Wavelength	950 nm
Optical resolution	30 mm
Range	100...18000 mm
Scan field	750 mm
Number of beams	50
With muting function	no
Scan Code	Adjustable
Electrical data	
Operating voltage	20...28 VDC
Residual ripple	< 10 % U _{ss}
DC rated operational current	≤ 100 mA
Short-circuit protection	yes
Reverse polarity protection	yes
Response time typical	< 17 ms
With restart interlock	yes
Blanking function	yes
Mechanical data	
Design	Rectangular, EZ-Screen
Dimensions	45 x 36 x 821 mm
Housing material	Metal, AL, Yellow polyester
Lens	plastic, Acrylic
Cascadable	No

Features

- Male M12 × 1, 5-pin
- Test function
- Protection class IP65
- Adjustment via DIP switch
- Operating voltage 24 VDC +15 %
- Resolution 30 mm
- Scan field 750 mm
- All devices incl. 2 EZA-MBK-11 mounting brackets; 900 mm devices and longer additionally incl. 1 EZA-MBK-12
- Personnel safety Cat 4, PL e acc. to EN ISO 13849-1:2008
- Type 4 according to IEC 61496-1,-2
- SIL 3 to IEC 61508

Wiring diagram

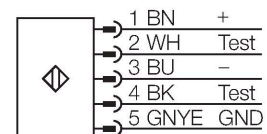

Functional principle

The high-resolution safety light screen for personnel protection consists of an emitter and a receiver. The system is optically synchronized, making the wiring between emitter and receiver redundant. The receiver's safety switching outputs are directly connected to a load relay and trigger an immediate stop of the dangerous machine cycle. Personnel safety degree type 4 acc. to IEC 61496 is fulfilled through 2 channel monitoring of the switching device and the multiple-redundant construction with mutual processor control.

Technical data

Electrical connection	Connector, M12 × 1
Number of cores	5
Ambient temperature	0...+50 °C
Protection class	IP65
Power-on indication	LED, Green
Tests/approvals	
Vibration resistance	10-55 Hz at 0.35 mm
Shock test	10 g at 16 ms (6000 cycles)
Approvals	CE, cULus listed

Accessories

EZA-MBK-11

3071470

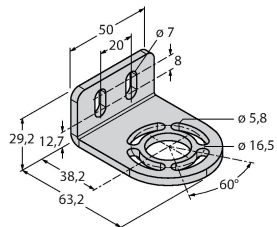

Mounting bracket, steel, black-finished, for EZ-ARRAY and EZ-SCREEN standard and cascade 14 & 30 mm

EZA-MBK-12

3071756

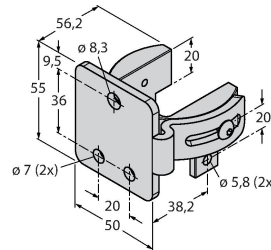

Mounting bracket, steel, black-finished, for EZ-ARRAY and EZ-SCREEN standard and cascade 14 & 30 mm

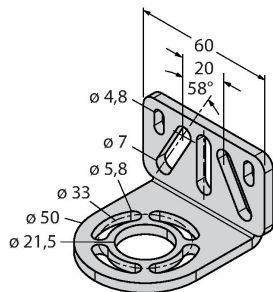

EZA-MBK-20

3072587



Mounting bracket, steel, black-finished, for EZ-ARRAY and EZ-SCREEN standard 14 & 30 mm

Accessories

Dimension drawing	Type	ID	
	QDE-515D	3070880	Connection cable for safety light screens, PVC, yellow, length 4.57 m, female connection, M12 x 1, 5-pin
	QDE-525D	3070881	Connection cable, PVC, yellow, length: 2.44 m, female M12 x 1 - male M12, 8-pin
	QDE-550D	3070882	Connection cable for safety light screens, PVC, yellow, length 15.3 m, female connection, M12 x 1, 5-pin
	QDE-575D	3071464	Connection cable, PVC, yellow, length: 22.9 m, female M12 x 1, 5-pin

Dimension drawing	Type	ID	
	QDE-5100D	3071465	Connection cable for safety light screens, PVC, yellow, length 30.5 m, female connection, M12 x 1, 5-pin
	DEE2R-51D	3072333	Connection cable, PVC, yellow, length: 0.31 m, female M12 x 1 - male M12 x 1, 5-pin
	DEE2R-53D	3072334	Connection cable, PVC, yellow, length: 0.91 m, female M12 x 1 - male M12 x 1, 5-pin
	DEE2R-58D_	3072636	Connection cable, PVC, yellow, length: 2.44 m, female M12 x 1 - male M12 x 1, 5-pin
	DEE2R-515D	3072335	Connection cable, PVC, yellow, length: 4.57 m, female M12 x 1 - male M12 x 1, 5-pin
	DEE2R-525D	3072336	Connection cable, PVC, yellow, length: 7.62 m, female M12 x 1 - male M12 x 1, 5-pin
	DEE2R-550D	3072337	Connection cable, PVC, yellow, length: 15.2 m, female M12 x 1 - male M12 x 1, 5-pin
	DEE2R-575D	3072338	Connection cable, PVC, yellow, length: 22.9 m, female M12 x 1 - male M12 x 1, 5-pin
	DEE2R-5100D	3072339	Connection cable, PVC, yellow, length: 30.5 m, female M12 x 1 - male M12 x 1, 5-pin
	DEE2R-58D	3094307	Connection cable, PVC, yellow, length: 2.44 m, M12 x 1 female connector, 5-pin, on M12 x 1 male connector, 5-pin