

RI-10S10C-2B4096-H1181

Incremental Encoder

Industrial Line

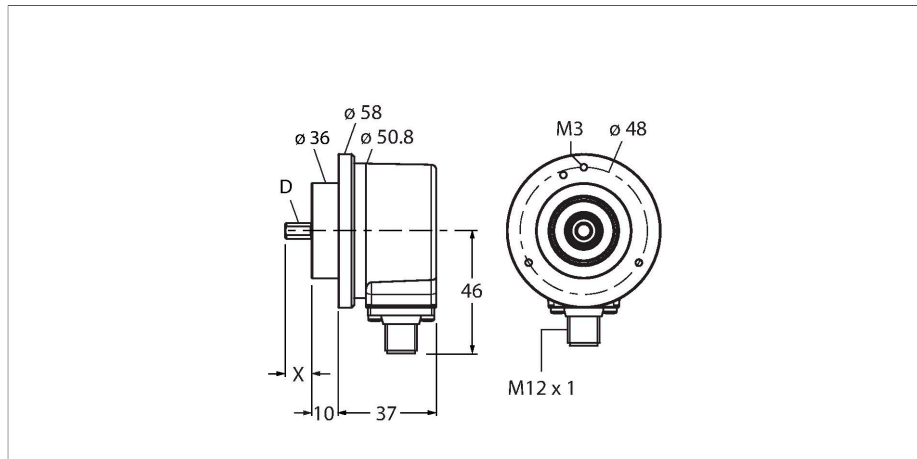

Features

- Clamping flange, Ø 58 mm
- Solid shaft, Ø 10 mm × 20 mm
- Optical measuring principle
- Shaft material: stainless steel
- Protection class IP67 on housing and shaft side
- -40...+85 °C
- Max. 6000 rpm (continuous operation 3000 rpm)
- 10...30 VDC
- Push-pull/HTL with inversion
- Pulse frequency max. 300 kHz
- M12 × 1 male, 8-pin
- 4096 pulses per revolution

Technical data

Type	RI-10S10C-2B4096-H1181
Ident. no.	1545207
Measuring principle	Photoelectric
Max. Rotational Speed	6000 rpm
Moment of inertia of the rotor	$1.8 \times 10^{-6} \text{ kgm}^2$
Starting torque	< 0.05 Nm
Ambient temperature	-40...+85 °C
Operating voltage	10...30 VDC
No-load current	≤ 100 mA
Output current	≤ 30 mA
Short-circuit protection	yes
Wire breakage/Reverse polarity protection	yes
Output function	Push-Pull/HTL, invertable
Output type	incremental
Resolution, incremental	4096 ppr
Pulse frequency max.	300 kHz
Signal level high	min. $U_B - 1 \text{ V}$
Signal level low	max. 0.5 V
Design	Solid shaft
Flange type	Clamping flange
Flange diameter	Ø 58 mm
Shaft Type	Solid shaft
Shaft diameter D (mm)	10
Shaft length X	20 mm
Shaft material	Stainless steel
Housing material	Die-cast zinc

Wiring diagram

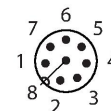
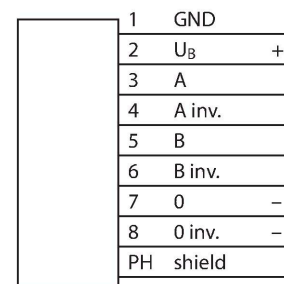

Technical data

Electrical connection	Connectors, M12 × 1
	8-pin
Axial shaft load	50 N
Radial shaft load	100 N
Vibration resistance (EN 60068-2-6)	300 m/s ² , 10...2000 Hz
Shock resistance (EN 60068-2-27)	3000 m/s ² 6 ms
Protection class housing	IP67
Protection class shaft	IP67

Signal	Gnd	+U_e	A	A inv.	B	B inv.	0	0 inv.	Shield
Pin configuration	1	2	3	4	5	6	7	8	PH

Accessories

<p>RCS-19-10-10</p>	<p>1545356</p> <p>Bellows coupling, outer diameter: 19 mm, bore diameter: 10 mm/10 mm</p>	<p>RCS-19-10-08</p>	<p>1545357</p> <p>Bellows coupling, outer diameter: 19 mm, bore diameter: 10 mm/8 mm</p>
<p>RCS-19-10-06</p>	<p>1545358</p> <p>Bellows coupling, outer diameter: 19 mm, bore diameter: 10 mm/6 mm</p>	<p>RCS-19-12-10</p>	<p>1545355</p> <p>Bellows coupling, outer diameter: 19 mm, bore diameter: 12 mm/10 mm</p>
<p>RFA-2</p>	<p>1544631</p> <p>Aluminium flange adapter, rectangular, for solid shaft encoders with clamping flange; edge length 63.5 mm; 3 mm thick</p>	<p>RFA-13</p>	<p>1544642</p> <p>Aluminium flange adapter, rectangular, for solid shaft encoders with clamping flange; edge length 80 mm; 4 mm thick</p>
<p>RFA-1</p>	<p>1544630</p> <p>Aluminium flange adapter, rectangular, for solid shaft encoders with clamping flange; edge length 58 mm; 4 mm thick</p>	<p>RFA-4</p>	<p>1544633</p> <p>Euro flange – aluminium flange adapter for solid shaft encoders, Ø 115 mm; reference diameter 100 mm; adapts 58 mm clamping flange to Euro flange</p>
<p>RFA-6</p>	<p>1544635</p> <p>Aluminium flange adapter for solid shaft encoders with clamping flange, Ø 58 mm; adapts clamping flange to synchro flange</p>	<p>RFA-7</p>	<p>1544636</p> <p>Aluminium flange adapter for solid shaft encoders, Ø 65 mm; adapts to Ø 65 mm flange and 48 mm reference diameter</p>

RFA-8

1544637

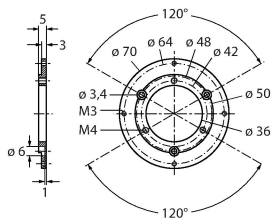

Aluminium flange adapter for solid shaft encoders with clamping flange, Ø 70 mm; thickness 4 mm, adapts to Ø 70 mm flange

RFA-9

1544638

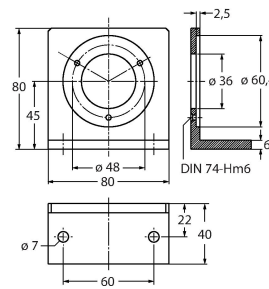

Aluminium angle flange for solid shaft encoders with Ø 58 mm clamping flange

RFA-11

1544640

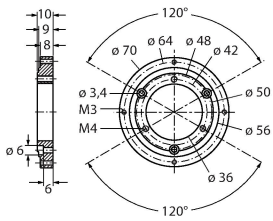

Aluminium flange adapter for solid shaft encoders with clamping flange, Ø 70 mm; thickness 10 mm, adapts to Ø 70 mm flange

RFA-12

1544641

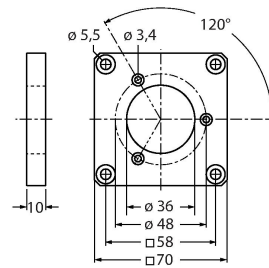

Aluminium flange adapter, rectangular, for solid shaft encoders with clamping flange; edge length 70 mm; 10 mm thick