

Original Instruction Manual

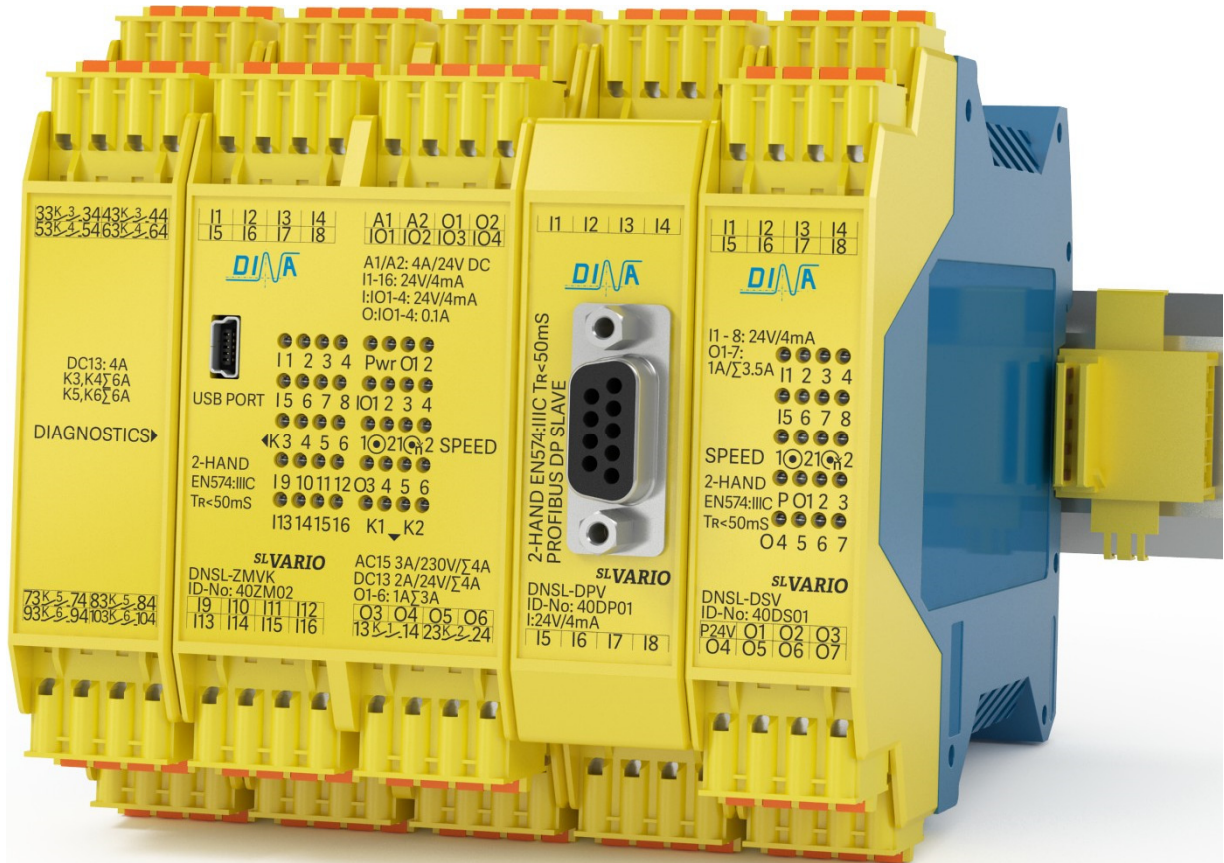

we are safety.

The direct way to safe automation

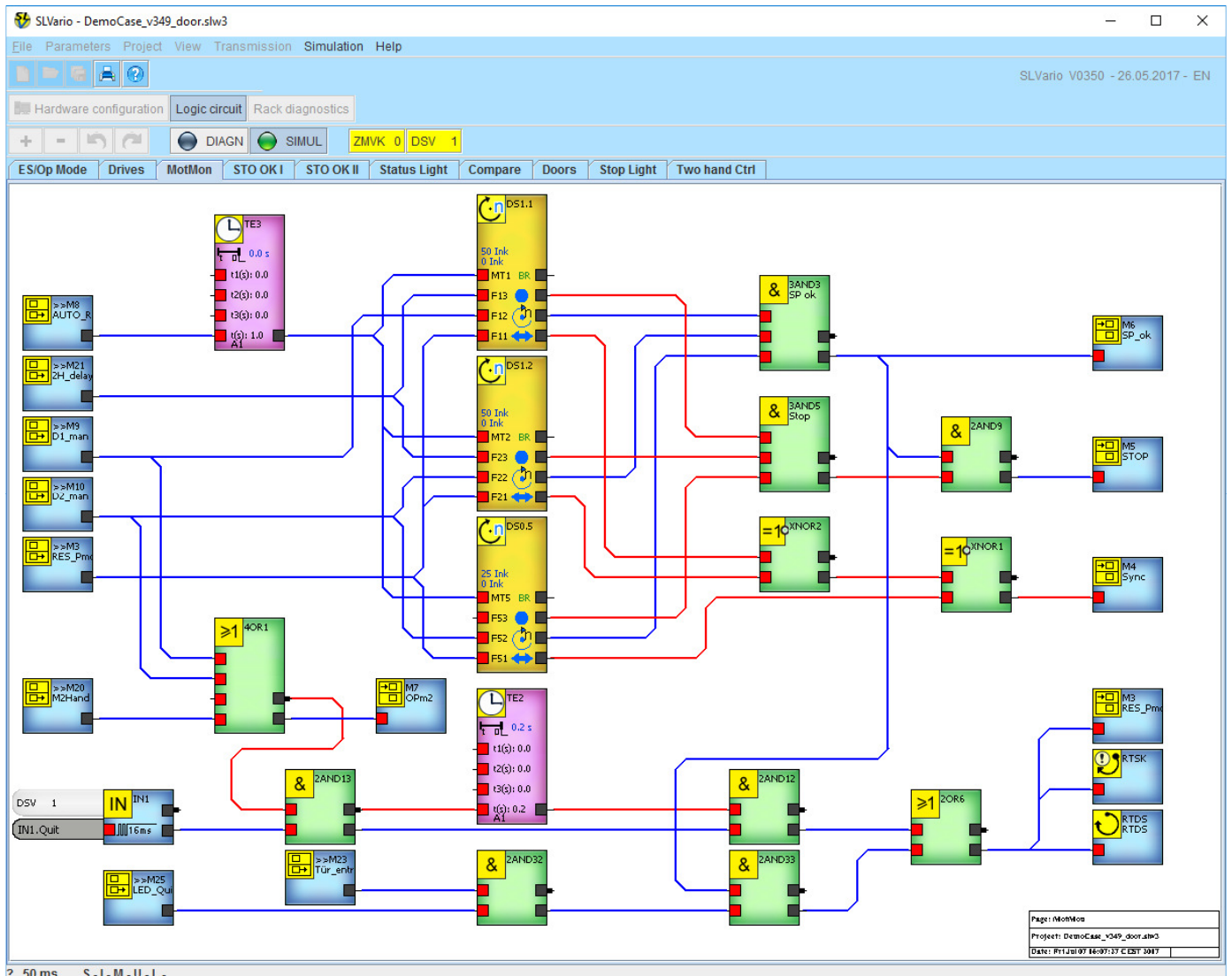
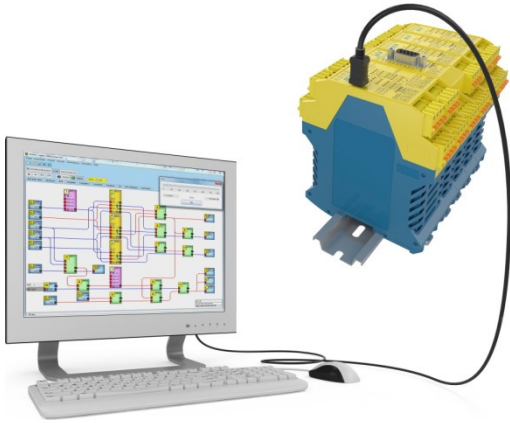

Contents

Contents

1	SL VARO Modules.....	6
2	Intended purpose	6
2.1	Certification data.....	6
3	Safety regulation.....	7
3.1	Important notes and validation	7
4	Product description	8
4.1	Mounting	9
4.2	Terminal	9
5	Central modules.....	10
5.1	Connection schematic	10
5.2	Central module DNSL-ZMVA.....	11
5.3	Front side.....	12
5.4	Switching status display	12
6	Standstill and speed monitoring.....	13
6.1	Connection schematic	13
6.2	Front side.....	14
6.3	Switching status display	14
7	In-, output modules.....	15
7.1	Connection schematic	15
7.2	Front side.....	16
7.3	Switching status display	16
8	Field bus modules.....	17
8.1	Usage	17
8.2	Connection schematic	17
8.3	Front side.....	18
8.4	Switching status display	18
9	Cascade module DNSL-CMV.....	19
9.1	Usage.....	19
9.2	Serial cascade.....	19
9.3	Addressing of the function modules.....	20
9.4	Front and side view	20
9.5	Switching status display	20
10	Network module DNSL-NIV	21
10.1	Usage of DNSL-NIV	21
10.2	Connection schematic	21
10.3	Networking of SL VARIO applications	21
10.4	Front and side view	22
10.5	Switching status display	22
11	Network module DNSL-NRV	23
11.1	Usage of DNSL-NRV.....	23
11.2	Connection schematic	24
11.3	RJ45 Female connection schematic, front and side view.....	24

Contents

12	Inputs for safety functions	25
12.1	Analogue inputs at the central module.....	25
12.2	Inputs for function mode selection switch (FMSS) at central module	25
12.3	Inputs for Tow-Hand function according EN 574: Type IIIC.....	25
12.4	Inputs for shut down mats, switch rails and bumpers at central module.....	26
12.5	Important notes with using of shutdown mats, switch rails and bumpers	26
12.6	Inputs for Safety circuits (SC) with manual Quit.....	27
12.7	Inputs for Safety circuits (SC) with Quit via Q.....	28
12.8	Quit of safety circuit (SC).....	28
12.9	Inputs for Safety circuits (SC) without Quit.....	29
13	Data in- and outputs at the field bus.....	29
14	Inputs for standstill and speed monitoring.....	30
14.1	Inputs for standstill and speed monitoring at the central module	30
14.2	Requirements for the sensors for safe monitoring.....	30
14.3	Input for safe standstill and speed monitoring at DNSL-DSV and DSV2	31
14.4	Requirements of the incremental measuring system	31
14.5	Two sensors measuring system with DNSL-DSV	31
14.6	Ramp monitoring with DNSL-DSV and DSV2	32
14.7	Inputs for standstill and speed monitoring at DNSL-DSIV	32
14.8	Input for standstill and speed monitoring at DNSL-DRV.....	32
14.9	Inputs for standstill and speed monitoring at DNSL-SIV.....	33
14.10	Direction monitoring with DSV, DSV2, DSIV, DRV und SIV	33
14.11	Quit of speed monitoring	33
14.12	DNCO function to monitor the Peripheral speed	34
14.13	DNCO1 connection schematic.....	34
14.14	Selection of DNCO-Multiplexer	34
15	Cable adapter DNDA.....	35
16	Outputs at SL VARIO	36
17	General technical data	37
17.1	Electrical characteristics	37
17.2	Environment conditions.....	37
17.3	Technical data of the Semiconductor outputs.....	37
	Technical data Semiconductor outputs.....	37
17.4	Technical data of the contact outputs.....	38
17.5	Electrical life of the contact outputs	38
18	Dimensions.....	39
18.1	Fitting and remove	39

1 SL VARO Modules

Central modules	Speed monitoring	In-, output modules	Network module	Field busses	Cascade module
DNSL-ZMV DNSL-ZMVA DNSL-ZMVD DNSL-ZMVK	DNSL-DSV DNSL-DSV2 DNSL-DSIV DNSL-DRV DNSL-SIV	DNSL-INV DNSL-IOV DNSL-RMV	DNSL-NIV DNSL-NRV	DNSL-COV DNSL-DPV DNSL-ECV DNSL-EPV DNSL-MOV DNSL-PLV DNSL-PNV	DNSL-CMV

2 Intended purpose



Testing based on:

EN 55011: 2009+A1 2010 (class A), DIN EN 61326-1: 2013-07, EN 61000-6-2: 2016-05, EN 61326-3-1: 2015-06, EN 61000-4-11: 2005-02

- DIN EN 60947-5-1: 2015-05
Low-voltage switch gear, part 5.1: Control circuit devices and switching elements-electromechanical control circuit devices
- DIN EN ISO 13849-1: 2016-06
Safety-related parts of control systems; Part 1: General principles for design category 4, PLe
- DIN EN ISO 13849-2: 2013-02
Safety-related parts of control systems; Part 2: Validation
- DIN EN 62061: 2016-05
Functional safety of safety-related electrical, electronic and programmable electronic control systems SIL CL3
- DIN EN 574, type IIC, two-hand control devices, DNSL-SIV type IIIB
- DIN EN ISO 13856-1:2013-08 / -2:2013-08 / -3:2013-12, for signal processing only
- GS-ET-20: 2016-10, basic principles for testing and certification of safety switch devices

Authorized person for the combination of the technical documents: Dirar Najib, CEO
Esslinger Str. 84, D 72649 Wolfschlugen,
Wolfschlugen, 2017-07-27

2.1 Certification data

Modul	MTTFd	PL	DC	SFF	PFHd	 <p>ET 13033 Sicherheit geprüft tested safety</p>  <p>US LISTED IND.CONT.EQ 1ZD7</p>  <p>T_M:20 years</p>
DNSL-ZMV	79 years	E	high	99%	3.0 x 10 ⁻⁸	
DNSL-ZMVK	141 years	E	high	99%	1.6 x 10 ⁻⁸	
DNSL-DSV	97 J years	E	high	96%	2.5 x 10 ⁻⁸	
DNSL-DRV	97 years	E	high	96%	2.5 x 10 ⁻⁸	
DNSL-SIV	165 years	D	high	95%	3.3 x 10 ⁻⁸	
DNSL-INV	238 years	E	high	95%	1.4 x 10 ⁻⁸	
DNSL-IOV	97 years	E	high	96%	2.5 x 10 ⁻⁸	
DNSL-RMV	91 years	E	high	98%	2.5 x 10 ⁻⁸	
DNSL-CMV	91 years	E	high	98%	2.5 x 10 ⁻⁸	
DNSL-NIV	214 years	D	high	95%	1.1 x 10 ⁻⁸	
DNSL-DPV	305 years	E	high	95%	8.0 x 10 ⁻⁹	
DNSL-ECV	305 years	E	high	95%	8.0 x 10 ⁻⁹	
DNSL-COV	305 years	E	high	95%	8.0 x 10 ⁻⁹	

Product is evaluated as safety device according:

- DIN EN ISO 13849-1: 2008-12, category 4, PLe, DIN EN 62061: 2005-10, SIL CL 3
- Certificated by: (Fachausschuss für Elektrotechnik, Prüf- und Zertifizierungsstelle Köln), European notified institution, Identification-number 0340
EC-Type Test certificate (DGUV Test: ET 13032 from 13-05-2013)
- EMC-directive certificated by "ELMAC GmbH Bondorf", Reg. No.: DAT-P-206/05-00
- CNL, USL: File E227037
- QM System certificated according to DIN EN ISO 9001:2015 by "DQS, Frankfurt", Reg.-No.: 067542 QM 08
- Certificate and declaration of conformity: See www.dina.de, download

3 Safety regulation

- The device may only be installed and commissioned by an electrician or trained persons who are familiar with these operating instructions and the applicable regulations regarding work safety and accident prevention.
- Observe the VDE, EN and local regulations, particularly with respect to the protective measures.
- Failure to observe the regulations may result in death, severe bodily injury or extensive property damage.
- For emergency-stop applications, either the integrated function for restart interlock must be used or automatic restarting of the machine must be prevented by means of a higher-level control.
- During transport, storage and operation adhere to the conditions specified in EN 60068-2-1, 2-2!
- Unauthorized modifications shall render any warranty null and void. Dangers may thereby arise that could result in severe injuries or even death.
- Install the device in a control cabinet with a protection class of at least IP54! Dust and moisture may otherwise result in impaired functions.
Installation in a control cabinet is mandatory.
- Ensure adequate protection circuits at output contacts for capacitive and inductive loads!
- The device is to be installed taking into account the distances required per DIN EN 50274, VDE 0660-514.
- During operation, switching devices carry dangerous voltage. Do not remove protective covers.
- Replace the device after the first malfunction!
- Properly dispose of the device at the end of its service life. 
- If these regulations are not adhered to or in the event of improper use, DINA Elektronik GmbH accepts absolutely no liability for the resulting property damages or personal injury.
- Save this product information!

3.1 Important notes and validation

- The product described here was developed to perform safety-related functions as part of a complete system.
- The complete system consists of sensors, evaluation and message units as well as concepts for safe shutdowns.
- It is the responsibility of the manufacturer of a system or machine to ensure the proper overall function.
- The manufacturer of the system is required to test and to document the effectiveness of the implemented safety concept within the complete system.
- This verification is to be performed after every modification to the safety concept or to safety parameters.
- DINA Elektronik is not in the position to guarantee the properties of a complete system that was not designed by DINA.
- DINA Elektronik GmbH also accepts no liability for recommendations that are given or implied by the following description.
- No new guarantee, warranty or liability claims that extend beyond DINA's general delivery conditions can be derived on the basis of the following description.
- To avoid EMC disturbances, the physical environmental and operating conditions at the installation location of the product must comply with section EMC of DIN EN 60204-1.
- The safety function must be required every month if there is performance level (e) and every year if there is performance level PLd is required by using contact outputs.
- The information in the general technical data at the end of the operating instructions must be adhered to.

4 Product description

- SL VARIO is a multi-functional, modular and configurable safety system.
- The system consists of a central module and different function- and field bus modules.
- The field bus enables a communication between SL VARIO and the field bus master.
- The product is appropriated to be used in machines and automation to avoid dangers.
- The central module is available in 45 or 67.5 mm housing depending on the quantity of outputs. All other modules are in 22.5 mm housing.
- Mounting happens on a 35 mm standard rail.
- The modules are connected directly to the ground via the standard rail.
- The modules are plugged together via a bus connector at the rail side. The bus is on 2 channels.
- Up to 15 modules can be used in one application.
- Modules with different functions are available.
- A variety of functions are available such as speed monitoring, logic modules, timers, safety circuits, mode selector, generator, counters, comparators, feedback, restart interlock functions.
- A lot of safe digital and analogue inputs, safe semiconductor and contact outputs are available.
- The status of inputs, outputs, power supply and diagnostic functions is displayed via LED.
- Online and rack diagnostic are available via the Designer.
- An application can be simulated without hardware.
- Overvoltage and overcurrent are monitored.
Voltage $\geq 30V$ or not connected terminal (A2) disconnects internally the terminals (A1) and (P).
- Semiconductor outputs are overload and short-circuit-proof.
- An internal temperature sensor for diagnostic function via the Designer is available in all modules.
- The user's application will be developed through the Designer. The data transfer happens via the USB interface at the central module.
- The Designer is software developed by DINA.
- A memory chip is installed inside the central module. Documents as application software, Designer and instruction manuals can be transferred to the memory using the USB interface.
- The memory chip can be used as a drive.

Remark

The function devices are tested safe and certificated as a part of the firmware.

A modification of the certified function devices as part of the firmware is excluded.

4.1 Mounting

- The central module is placed on the left side. All other modules must be added to the right side.
- For an application a central module is necessary.
- The number of the functional modules depends on the requirements.
- The plugs for measurement systems at the speed monitoring and for the data interface at the network and cascade module are on the top side of the module after mounting.
- RJ45 plugs are also at the bottom side of DNSL-ZMD and DNSL-NRV for speed monitoring and network. They are to use for description function only.
- The connecting cable can be fed directly into the cable channel.
- The field bus connector is at the front side.

Central module	Speed monitoring		In-, output modules				EtherCAT
DNSL-ZMVK	DNSL-DSIV	DNSL-DRV	DNSL-INV	DNSL-IOV	DNSL-RMV	Bus	DNSL-ECV

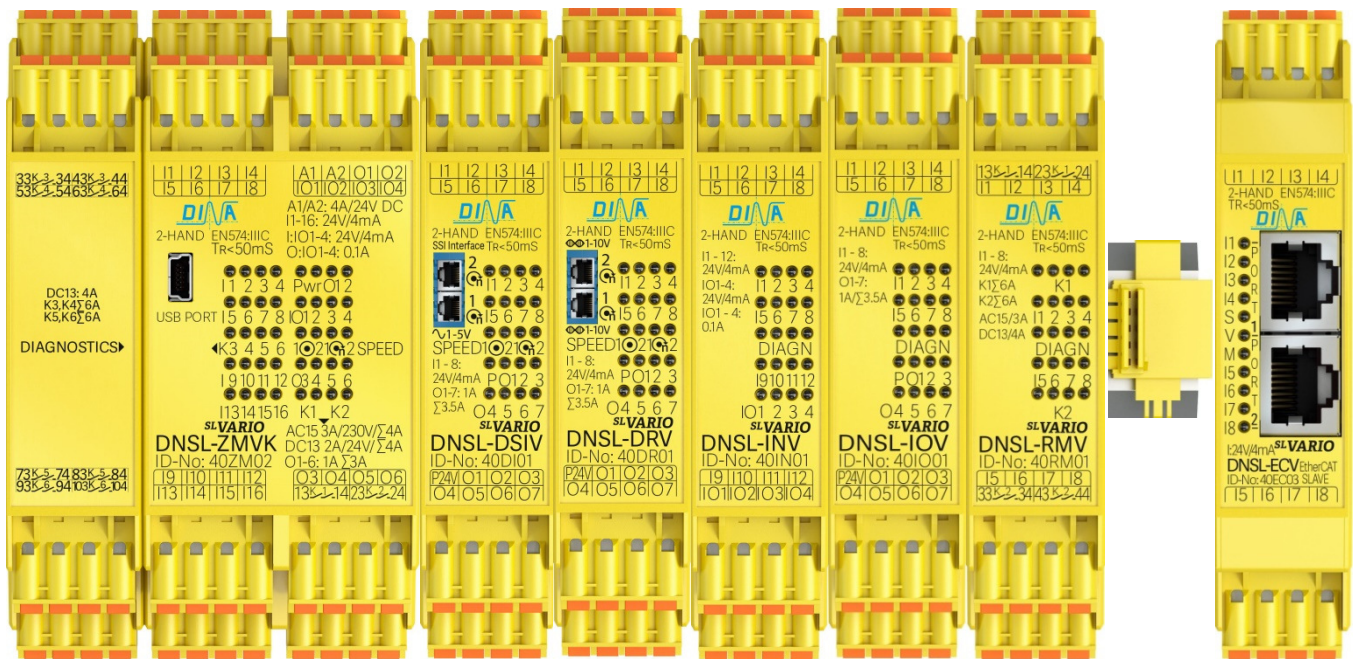

4.2 Terminal

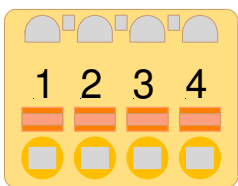

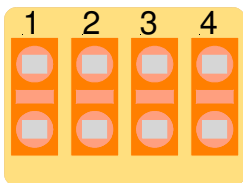

In standard the modules are equipped with single terminals.
Unlocking happen above the terminals

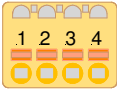
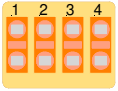

All modules are deliverable with twin terminals.
Unlocking: above or between the terminals

5 Central modules

				
DNSL-	ID-No.:	ID-No.:	Connector	Description
ZMV	40ZM01 40ZM31	40ZM21 40ZM32	I1-I8	Safe analogue-digital inputs for safety functions
ZMVK	40ZM02 40ZM04	40ZM22 40ZM24		
ZMVD	44ZM01 48ZM01	44ZM51 48ZM51		
ZMV	40ZM05 alle	40ZM25 alle		
	alle	alle	1: I9/I10 2: I11/I12	2 safe monitoring of standstill and speed via sensor with 24V signals
ZMV	40ZM03	40ZM23	1: I9-I12	2 safe monitoring of standstill, speed, position, direction and brake in different operating modes, HTL measuring system
ZMVK	40ZM04	40ZM24	2: I13-I16	
ZMVD	44ZM01 48ZM01	44ZM51 48ZM51	I17-I32	Safe digital inputs
ZMVD	48ZM01	48ZM51	I33-I48	Safe digital inputs
ZMVD	44ZM01 48ZM01	44ZM51 48ZM51		4 safe speed monitoring (44ZM51) 8 safe speed monitoring (48ZM51) of standstill, speed, position, direction and brake in different operating modes sin/cos or TTL measuring system
	alle	alle	IO1-IO4	Safe digital inputs or Safe semi-conductor outputs
	alle	alle	O1-O6	Safe semi-conductor outputs
	alle	alle	K1-K2	Safe contact outputs 40ZM31/ 32 not available
ZMVK	40ZM02 40ZM04	40ZM22 40ZM24	K3-K6	Safe contact outputs each 2 contacts
	alle	alle		USB interface for data transfer with data memory 40ZM31/32 without memory
	alle	alle	A1/ A2	Power supply 24V DC for central module and all other modules in the application. Monitored voltage

5.1 Connection schematic

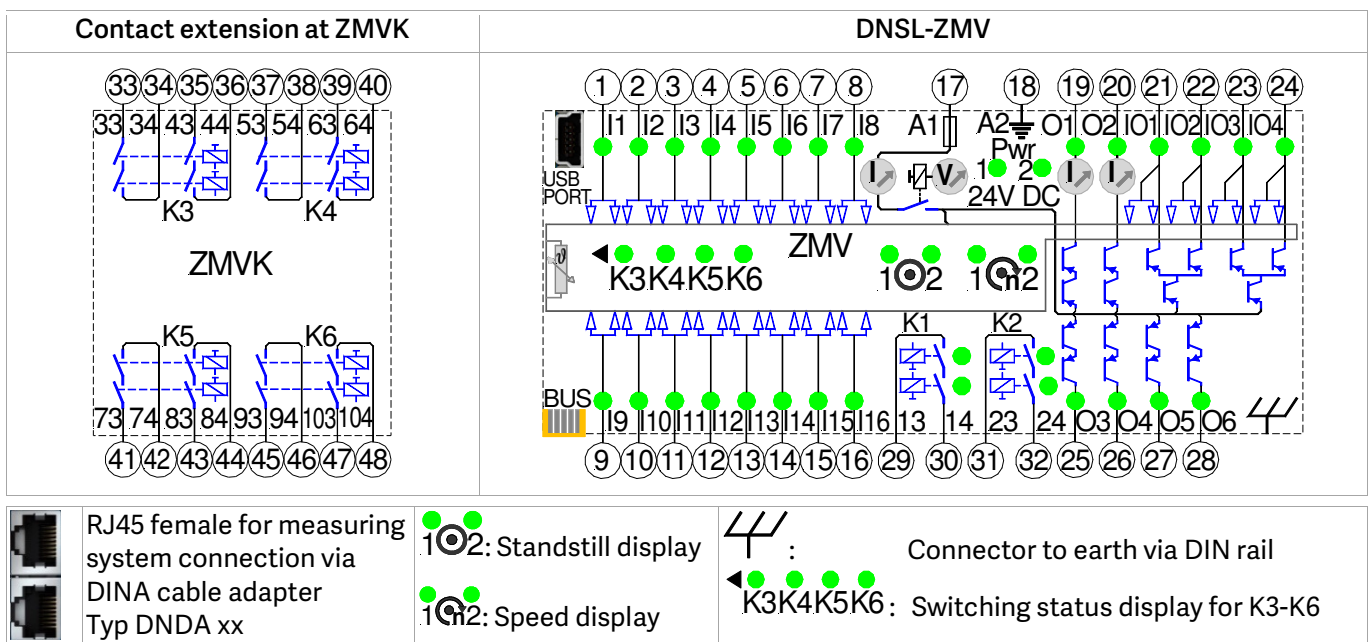

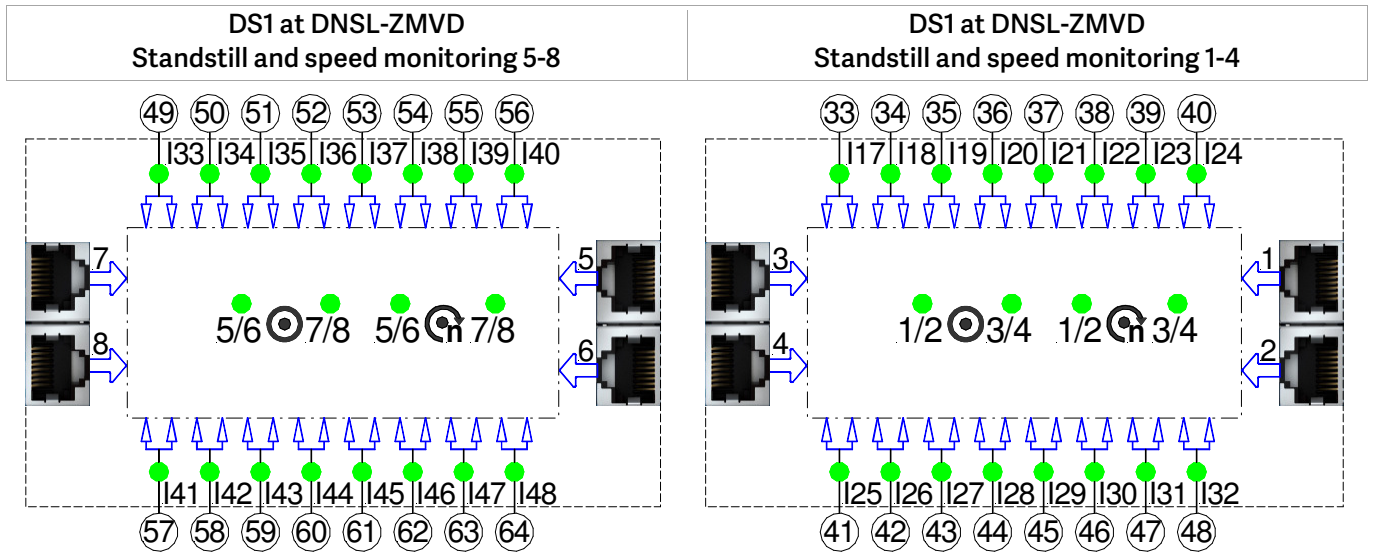

Equipment down side	Measuring system connector	Equipment upper side	Measuring system connector
	Monitoring 3 at DS1 Monitoring 7 at DS2 Monitoring 4 at DS1 Monitoring 8 at DS2		Monitoring 1 at DS1 Monitoring 5 at DS2 Monitoring 2 at DS1 Monitoring 6 at DS2

5.2 Central module DNSL-ZMVA

<p>Analogue part of DNSL-ZMVA Basis part: see DNSL-ZMV</p> <p style="text-align: center;">ZMVA</p>	<p>Front side DNSL-ZMVA</p>	<p>Description of the analogue part:</p> <p>The outputs AO1 to AO4: 4-20mA. The outputs AO5 to AO8: 0 bis 10V Current and voltage outputs are proportional to gather.</p> <p>AO1 (4 to 20mA) to AO5 (0...10V) AO2 (4 to 20mA) to AO6 (0...10V) AO3 (4 to 20mA) to AO7 (0...10V) AO4 (4 to 20mA) to AO8 (0...10V)</p> <p>The source to control the analogue outputs can be configured using the parameter mask at SL VARIO Designer. Sources are analogue terminals, standardized values (weight power), adders, subtractors etc. A minimum and a maximum has to be entered in the Designer mask. For more details see the instruction manual Designer.</p>
----------------------------------------------------------------------------------------------------------------------	------------------------------------	---------------------------------------------------------------------------------------------------------------------------------------------------------------------------------------------------------------------------------------------------------------------------------------------------------------------------------------------------------------------------------------------------------------------------------------------------------------------------------------------------------------------------------------------------------------------------------------------------------------------------------------------------------------------------------------

5.3 Front side

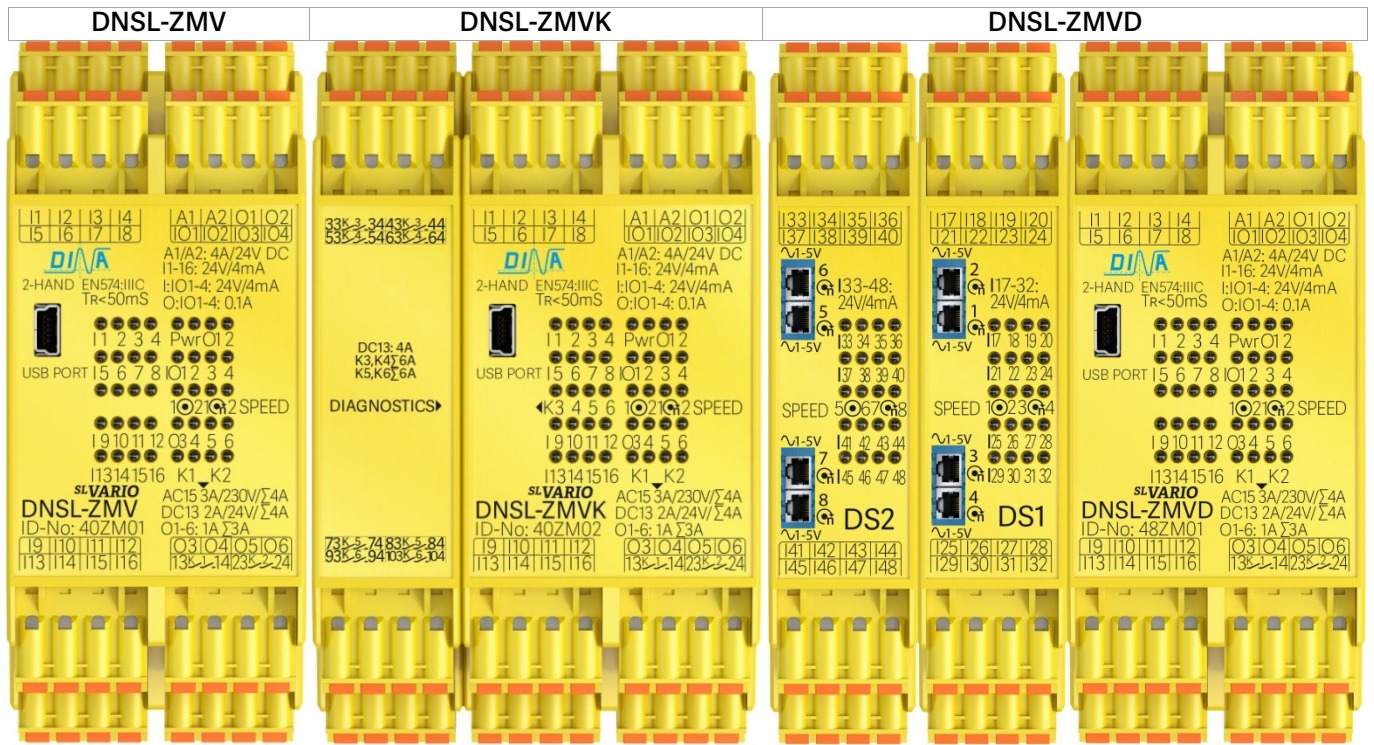



5.4 Switching status display

In-Outputs			Pwr: 1 2	
I1 — I48	Signal = 0V	Signal = 24V	Pwr 1: Data transfer	
IO1 – IO4	Signal = 0V	Signal = 24V	Pwr 1: Error	
1 2	n = 0	n > 0 / n = speed	Pwr 1: OK not Valid	
1 2	n < max.	n > max.	Pwr 1: Valid	
1 2	Measuring system not available		Pwr 2: Synchronisation	
O1 – O6	I = 0	I = 0 ≤ max.	Pwr 2: Error	
IO1 – IO4	I = 0	I = 0 ≤ max.	Pwr 2: OK	
K1 / K2				
K3 – K6				

Standstill and speed display at DS1			Standstill and speed display at DS2		
1 2	n = 0 at 1 and 2	n > 0 at 1, 2 or both	5 6	n = 0 at 5 and 6	n > 0 at 5, 6 or both
	n = 0 at 3 and 4	n > 0 at 3, 4 or both		n = 0 at 7 and 8	n > 0 at 7, 8 or both
3 4	n < max. at 1 and 2	n > max. at 1, 2 or both	7 8	n < max. at 5 and 6	n > max. at 5, 6 or both
	n < max. at 3 and 4	n > max. at 3, 4 or both		n < max. at 7 and 8	n > max. at 7, 8 or both
1 2	No Measuring system at 1	No Measuring system at 2	5 6	No Measuring system at 5	No Measuring system at 6
3 4	No Measuring system at 3	No Measuring system at 4	7 8	No Measuring system at 7	No Measuring system at 8

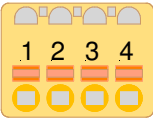
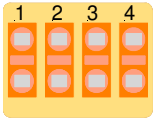
6 Standstill and speed monitoring

				
DNSL-	ID-No.:	ID-No.:	Connector	Description
DSV DSIV DRV SIV	40DS01 40DI01 40DR01 40SI01	40DS21 40DI21 40DR21 40SI21	11-18	Safe digital inputs for safety functions
	alle	alle		2 Safe monitoring of standstill, speed, position, direction and brake in different operating modes
DSV	40DS01	40DS21		Sin/Cos, TTL, HTL Measuring system,
DSV	40DS02	40DS22		HTL A and B track only
DRV	40DR01	40DR21		Resolver Measuring system
SIV	40SI01	40SI21		SSI Interface
DSIV	40DI01	40DI21		Sin/Cos, SSI interface with comparator function
DSV DRV	alle	alle	O1, O2	Semi-conductor outputs also clock outputs
DSV DRV	alle	alle	O3-O7	Safe semi-conductor outputs
DSV DSIV	40DS51 40DI01	40DS71 40DI21	O1-O7	Safe semi-conductor outputs
SIV	40SI01	40SI21	O1-O4	Safe semi-conductor outputs
	alle	alle	P	24V DC to supply the semi-conductor outputs Monitored voltage

6.1 Connection schematic

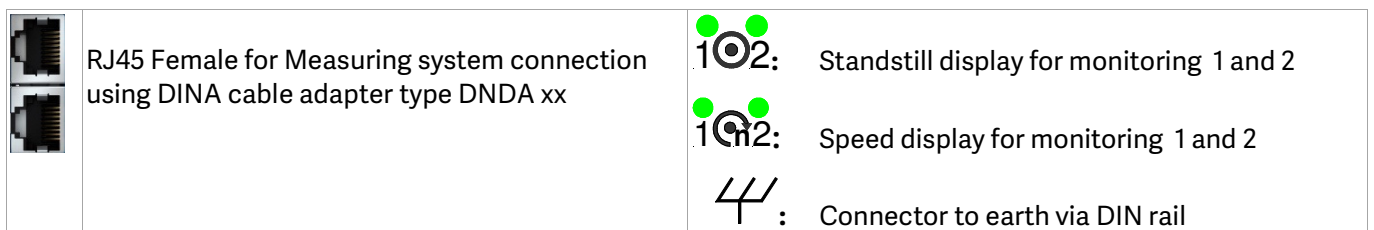
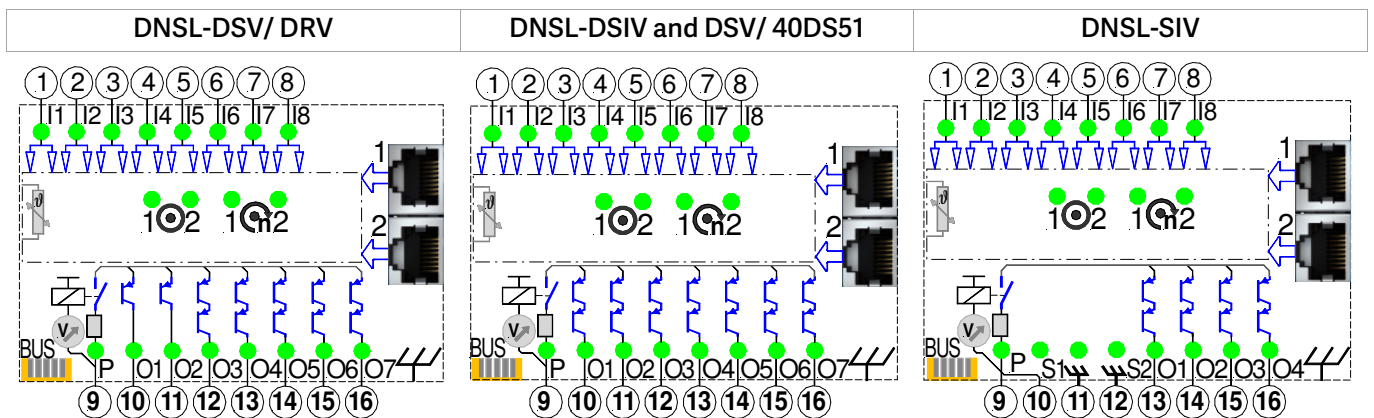

6.2 Front side

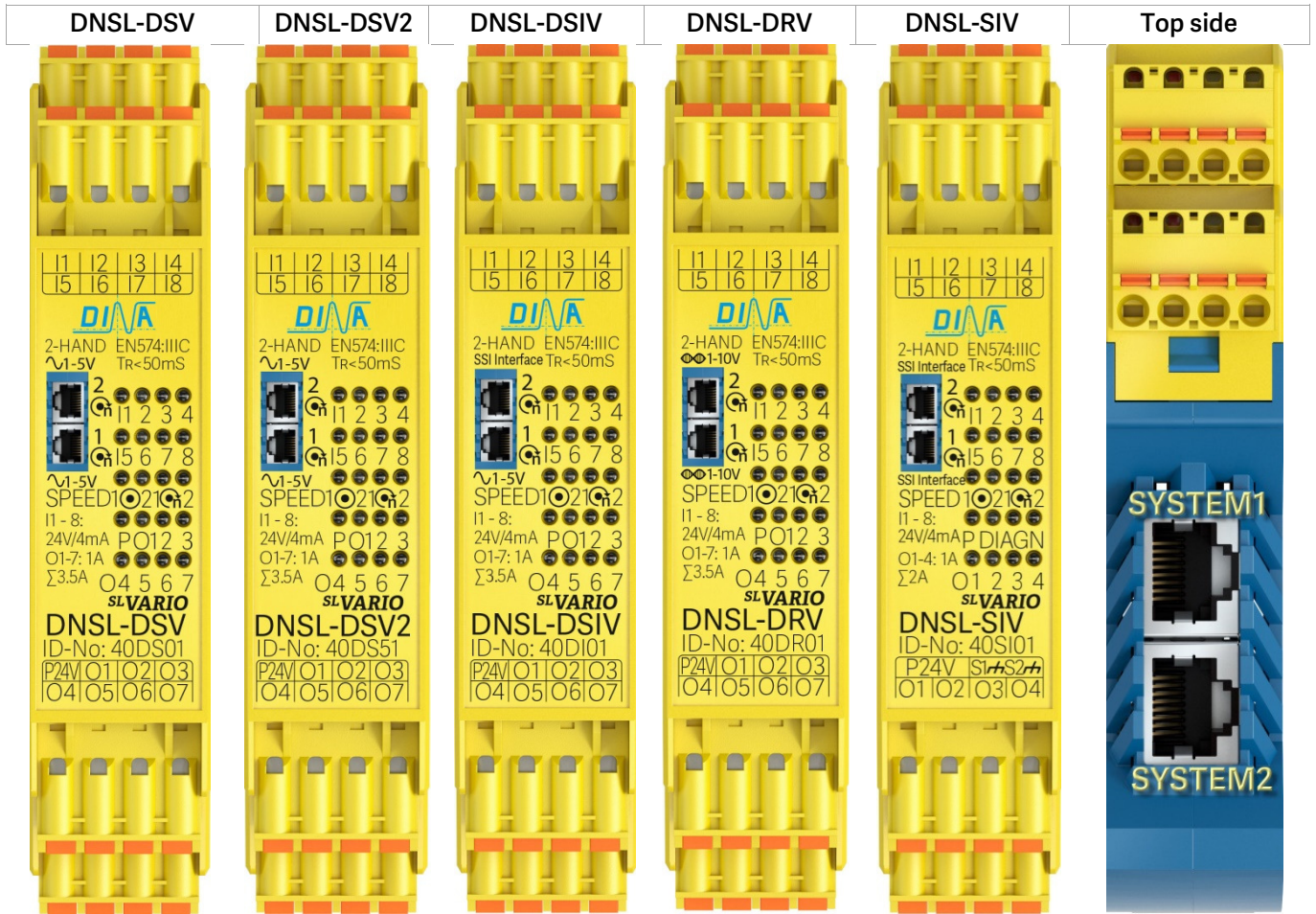

6.3 Switching status display

I1 – I8	Signal = 0V	Signal = 24V
P	Pwr = 0V	Pwr = 24V
1 2	1 2 n = 0 an 1 und 2	1 2 n > 0 at 1 and 2
1 2	1 2 n < max. an 1 und 2	1 2 n > max. at 1 and 2
1	No measuring system at monitoring 1	
2	No measuring system at monitoring 2	
O1 – O7	I = 0	I > 0 ≤ max.
O1 – O4	I = 0	I > 0 ≤ max.

n = Speed

7 In-, output modules

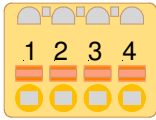
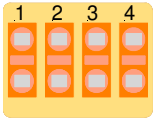
				
DNSL-	ID-No.:	ID-No.:	Connector	Description
INV	40IN01	40IN21	I1-I12	Safe digital inputs for safety functions
IOV	40IO01	40IO21	I1-I8	
RMV	40RM01	40RM21	I1-I8	
INV			I01-I04	Safe digital inputs Safe semi-conductor outputs
IOV			O1-O7	Safe semi-conductor outputs
RMV			K1, K2	Contact outputs each 2 safe NO
IOV			P	24V DC for the outputs Monitored voltage

7.1 Connection schematic

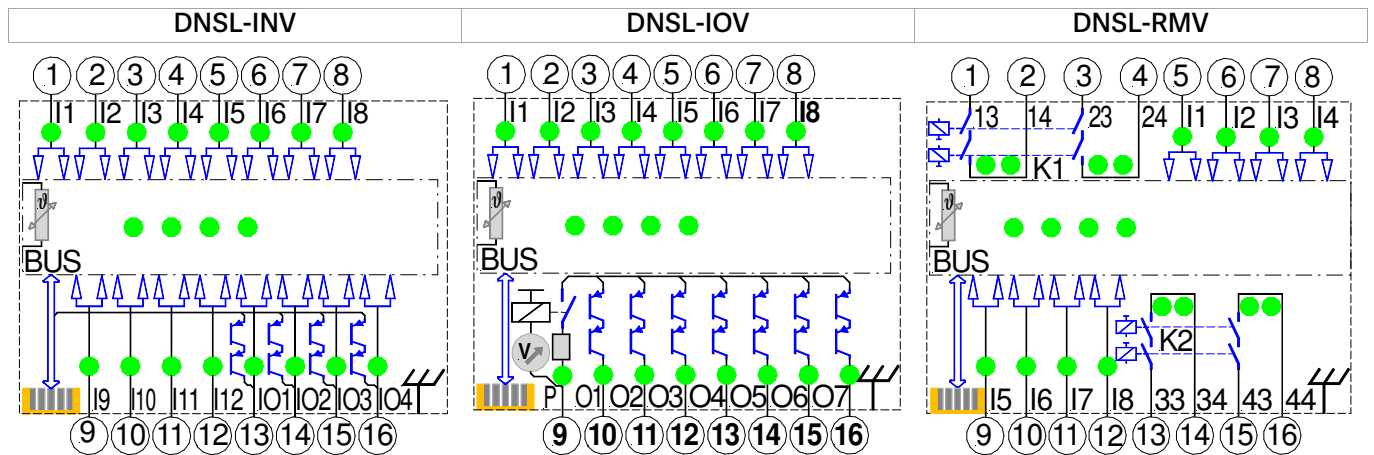

	LED Display for diagnostics		Connector to earth via DIN rail
-------------------------------------------------------------------------------------	-----------------------------	-------------------------------------------------------------------------------------	---------------------------------

7.2 Front side

DNSL-INV

DNSL-IOV

DNSL-RMV

7.3 Switching status display

DNSL-INV

I1– I12	Signal = 0 V	Signal = 24 V
IO1-IO4	Signal = 0 V	Signal = 24 V
IO1-IO4	I = 0	I > 0 ≤ max.
DIAGN	left CAN communication OK left: no CAN communication	2 – 4 right: module function OK 2 – 4 right: internal error

DNSL-IOV

I1 – I8	Signal = 0 V	Signal = 24 V
O1 – O7	I = 0	I > 0 ≤ max.
DIAGN	Always green	

DNSL-RMV

I1 – I8	Signal = 0 V	Signal = 24V
K1/ K2		
DIAGN	Always green	

8 Field bus modules

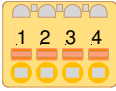
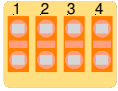
					
DNSL-	ID-No.:	ID-No.:	Function	Connector	Description
COV	40CO03	40CO23	CANopen		
DPV	40DP03 40DP04	40DP23 40DP24	Profibus DP	I1-I8	Safe digital inputs for safety functions all field bus modules
ECV	40EC03	40EC23	EtherCAT		
EPV	40EP03	40EP23	Ethernet /IP		4 Byte input data, all field bus modules
MOV	40MO03	40MO23	Modbus		8 Byte output data, all field bus modules
PLV	40PL03	40PL23	Powerlink		Number of Byte is configurable
PNV	40PN03	40PN23	ProfiNET		

8.1 Usage

- The digital inputs can be used for safety functions. See inputs for safety functions
- The field bus modules are for data transfer between SL-VARIO application and machine control via the field bus master.
- The data can be for diagnostics respectively for not safety relevant control signals
- Data transfer from or to the machine control are possible.

8.2 Connection schematic

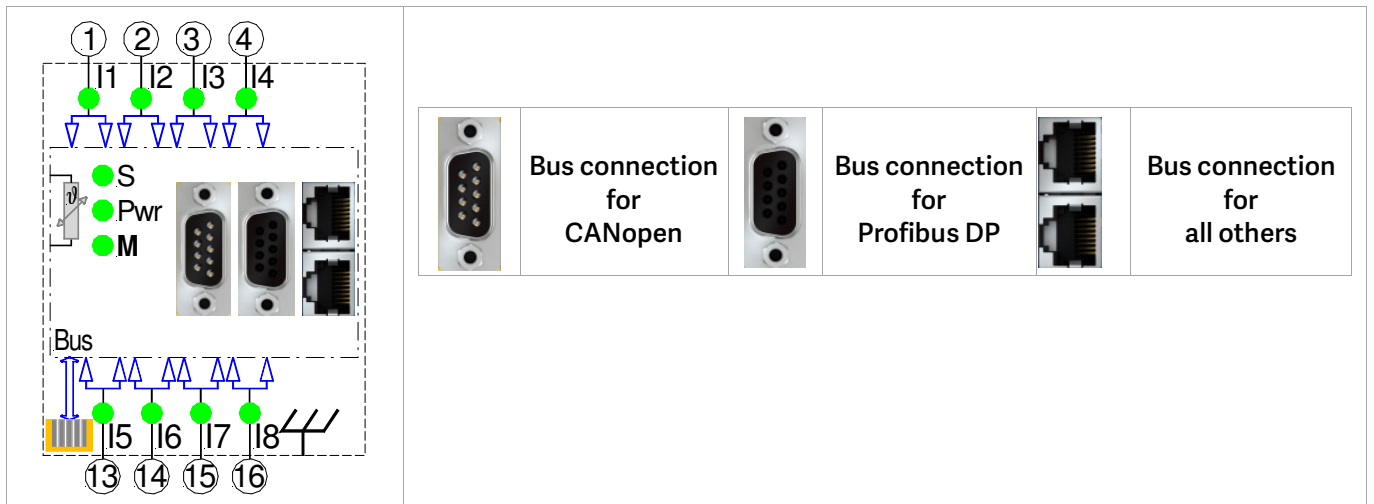

Othes on request

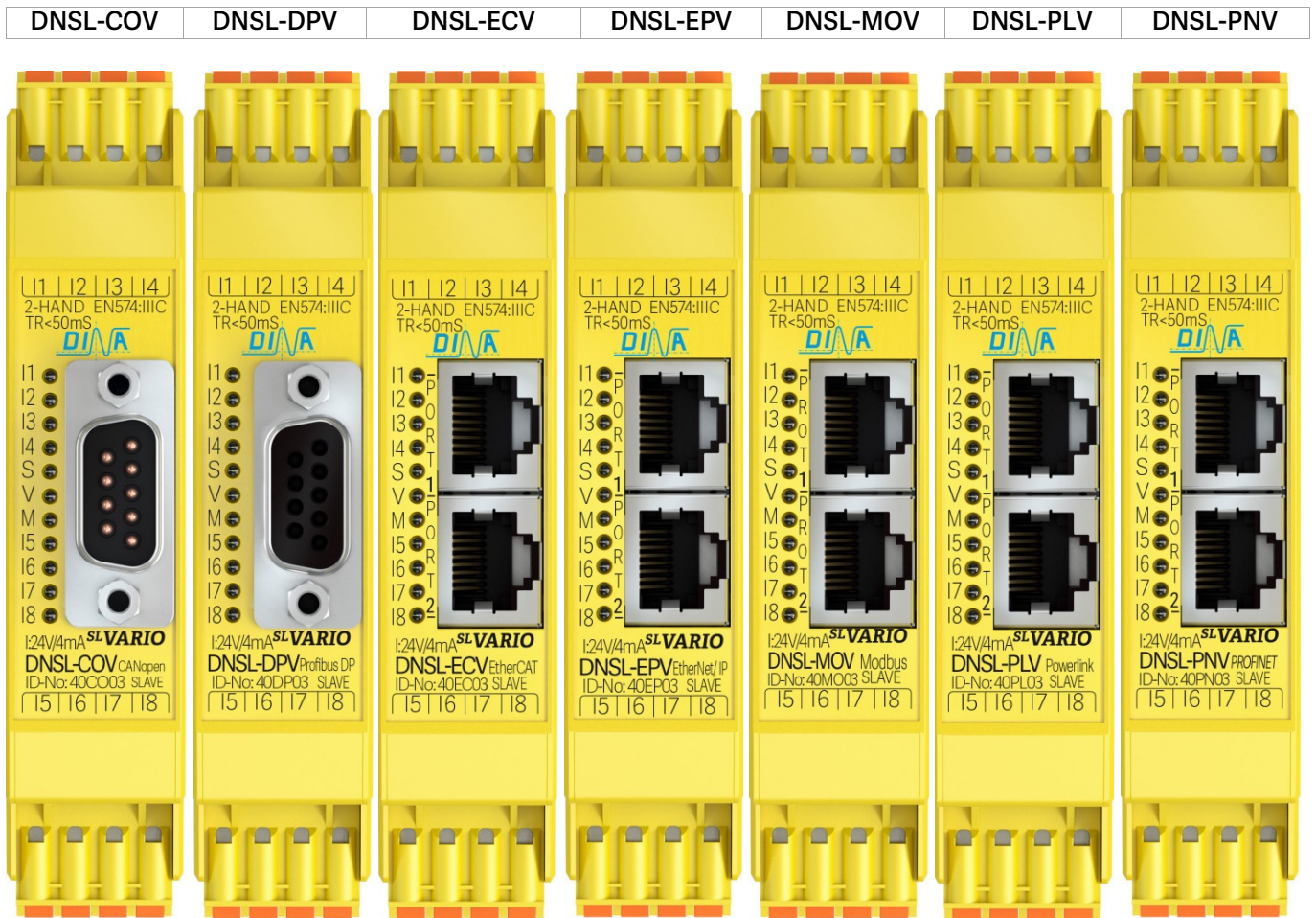

8.3 Front side



8.4 Switching status display

I1 – I8	Signal = 0V	Signal = 24V
V	Pwr = 0 V	Pwr = 24 V
M/ S	Error	OK

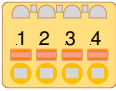
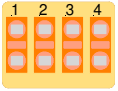
9 Cascade module DNSL-CMV

				
DNSL-CMV	ID-No.: 40CM02	ID-No.: 40CM22	Anschluss	Description
			AD1- AD4	Addressing inputs
			B	Input to adapt the bus system. In the periphery unit it must be connected to 24V DC.
				Communication interface between the base unit with the periphery unit
			A1, A2	Power supply 24V DC
			S1, S2	Interface grounding, module grounding via the rail

9.1 Usage

- Mounting of the modules of an application on different places to avoid costly wiring
- A cascade contains a base unit BU with central module and up to 5 periphery units PU
- In every unit is one DNSL-CMV.
- In the PU DNSL-CMV replaces the central module.
- Serial or starry cascade is possible.
- The units are via patch cables connected together.
- The maximal length of all patch cables is 100 m.
- The power supply 24V DC happens via A1/ A2 at CMV if there is patch cable length > 10 m.
- The addressing of the first FM in the PU happens via AD1–AD4 at CMV.
- The addressing of the follow modules in the PE happens automatically.
- 15 modules are possible in one application.
- The binary code enables 1 to 14 addresses.
- 0 and 15 are not allowed.
- B-input must be connected to 24V DC at periphery units.

Base units with the central module, necessary function modules and the cascade module DNSL-CMV	Periphery unit with DNSL-CMV and necessary function modules	Periphery unit with DNSL-CMV and necessary function modules
---------------------------------------------------------------------------------------------------	-------------------------------------------------------------	-------------------------------------------------------------

9.2 Serial cascade

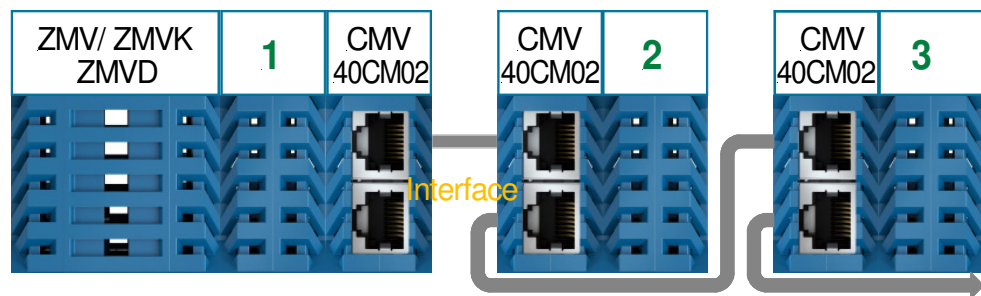

Star shape cascade

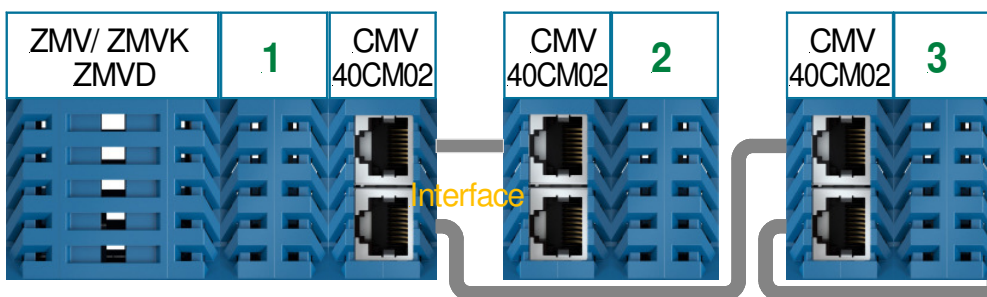

Length of all patch cable connection ≤ 100m

9.3 Addressing of the function modules

- The addressing of the first FM in the PU happens via AD1 – AD4 at CMV.
- The address of the follow modules in the PU happens automatically.





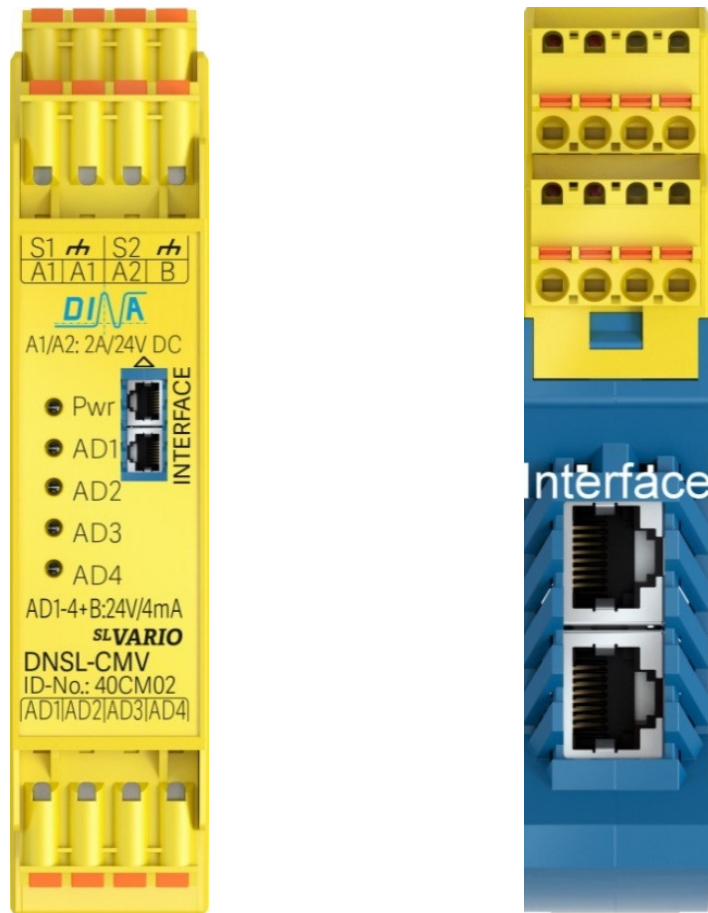

AD	BE/BU	CMV	PE1/PU1	PE2/PU2	PE3/PU3	AD1	AD2	AD3	AD4
0	ZMV								
1	FM1								
2	FM2								
3	FM3								
	CMV0								
4		CMV1	FM4						
5	auto		FM5						
6	auto		FM6						
7		CMV2		FM7					
8	auto			FM8					
9		CMV3			FM9				
10	auto				FM10				
11	auto				FM11				

By cascade modules we recommend the usage of patch cable with plugs from the company Hirose with the ID-no.: TM11AP-88P (61) to ensure the quality.



9.4 Front and side view



9.5 Switching status display

 Pwr	 Pwr = 0 V	 Pwr = 24 V
 AD1 – AD8	 Signal = 0V	 Signal = 24V

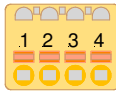
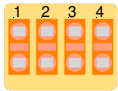
10 Network module DNSL-NIV

				
DNSL-NIV	ID-No.: 40NI01 40NI02	ID-No.: 40NI21 40NI22	Connector	Description
			I1-I8	Safe digital inputs for safety functions
				Communication interface
			O1-O4	Safe semi-conductor outputs
			P	24V DC for the outputs Monitored voltage
			S1, S2	Interface grounding

10.1 Usage of DNSL-NIV

- Data transfer between up to 8 applications
- For every system is one DNSL-NIV required.
- Via patch cable the applications will be contacted serial. The cable length can be max. 100 m.
- After a break of the data transfer a quit is required.
- Therefore a quit symbol in the Designer is provided.
- For data transfer 32 in- and 32 outputs.
- The configuration happens in the Designer.
- RJ45 connectors are to use for specified function only

10.2 Connection schematic

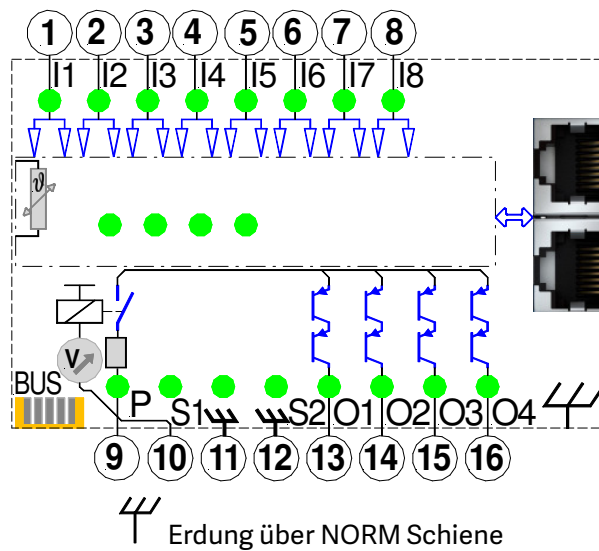

10.3 Networking of SL VARIO applications

networking up to 8 applications is possible.

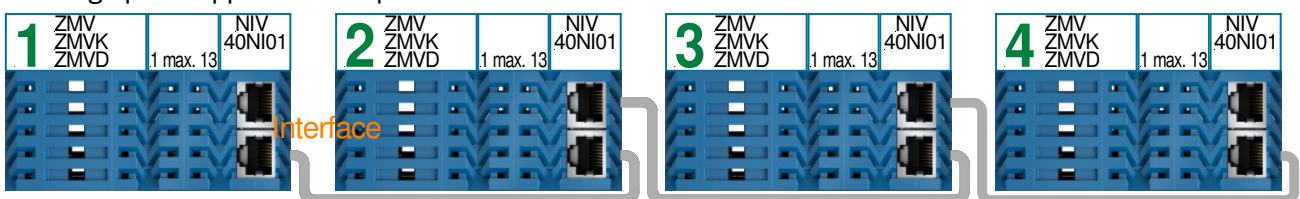

Length of all patch cable connection $\leq 100\text{m}$

10.4 Front and side view

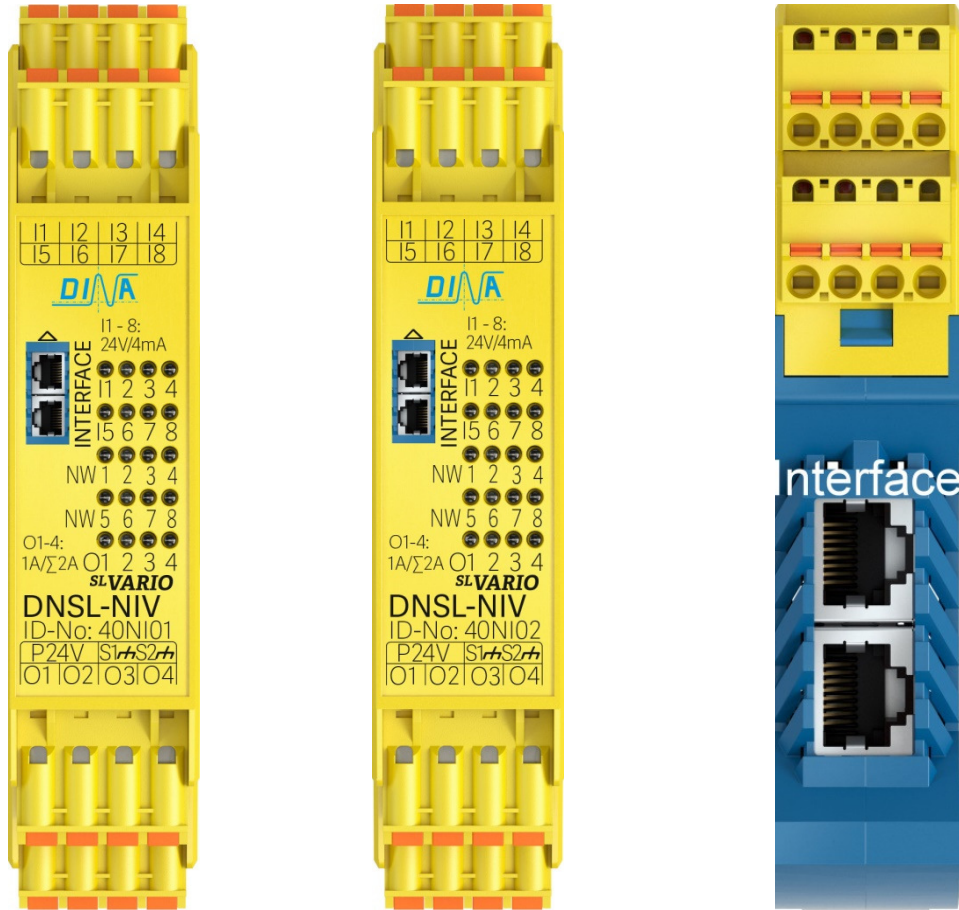



10.5 Switching status display

I1 – I8	Signal = 0V	Signal = 24V	
O1 – O4	I = 0	I > 0 ≤ max.	
NW 1 2 3 4	Network Address 1-4 for application 1-4	Local participant	Example 2: External participant 3 Receiving of data will be ignored Sanded data of 3 will be interpreted
NW 5 6 7 8	Network Address 5-8 for application 5-8	Example 1: External participant 6 Participant 6 with data transfer	Example 3: External participant 8 Participant 8 is not available

The addressing of the Participants happens at the Designer. Address 1 to 8 is possible.

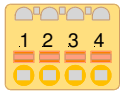
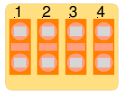
11 Network module DNSL-NRV

					
DNSL-NRV	ID-No.:	ID-No.:	Connector	Connector	Description
	40NR01	40NR21			Communication interface
			MH, ML, SH, SL		Communication interface
			A1, A2		Power supply 24V DC

11.1 Usage of DNSL-NRV

- Networking up to 8 applications is possible.
- The cable length between the applications can be up to 150 m.
- The RJ45 plugs placed at the side of NRV are only to connect with the RJ45 plugs at NIV (40NI02).
- The RJ45 plug at the front side of NRV is to connect with the RJ45 plug at NIV (40NI01).
- The connection of the four network plugs at the side of NRV is displayed via LED, at the front side is not displayed.
- The connection from NRV to NIV (40NI02) can be happen at RJ45 plug 1 or 2.

11.2 Connection schematic

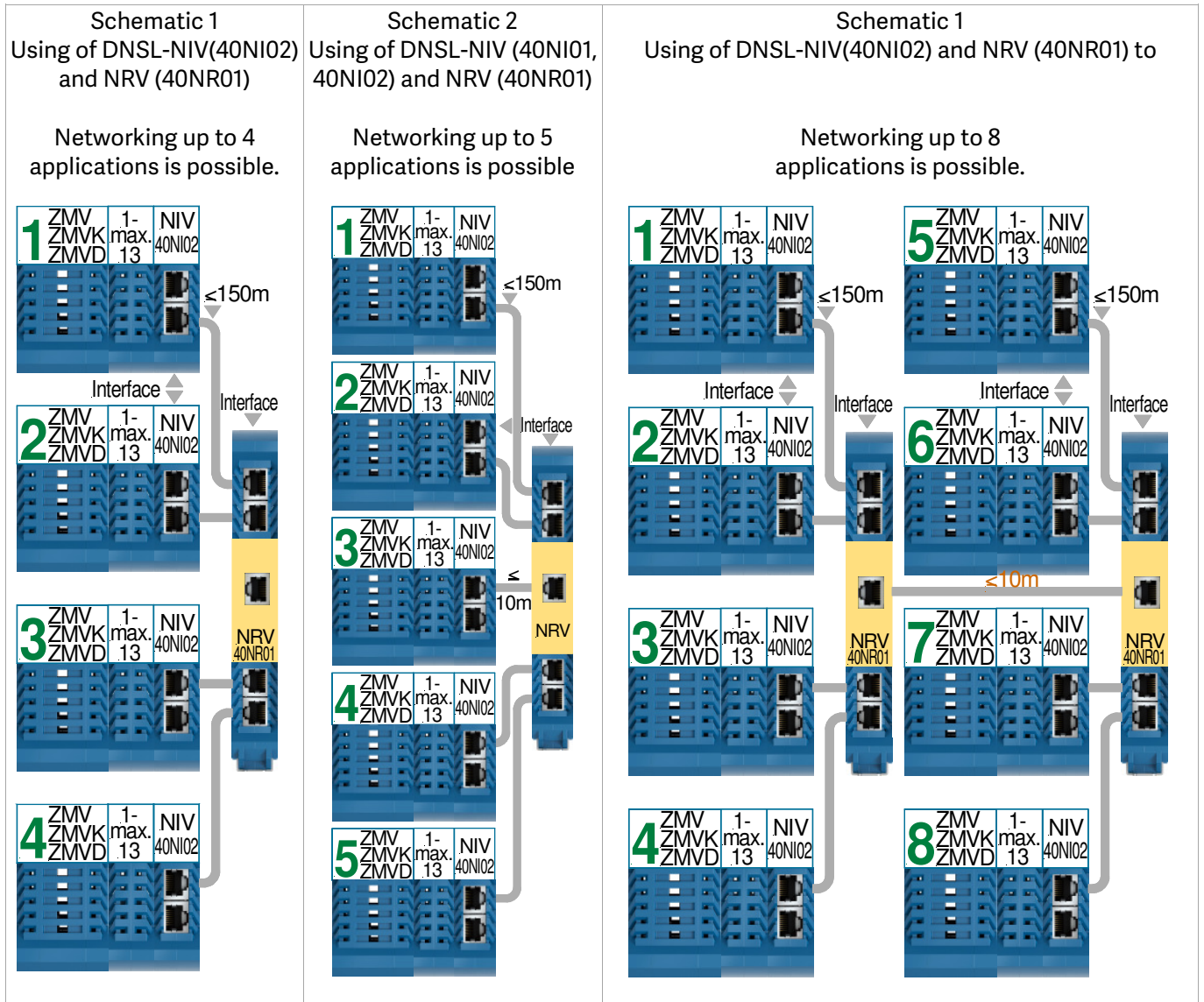

By network modules we recommend the usage of patch cable with plugs from the company Hirose with the ID-no.: TM11AP-88P (61) to ensure the quality.

11.3 RJ45 Female connection schematic, front and side view

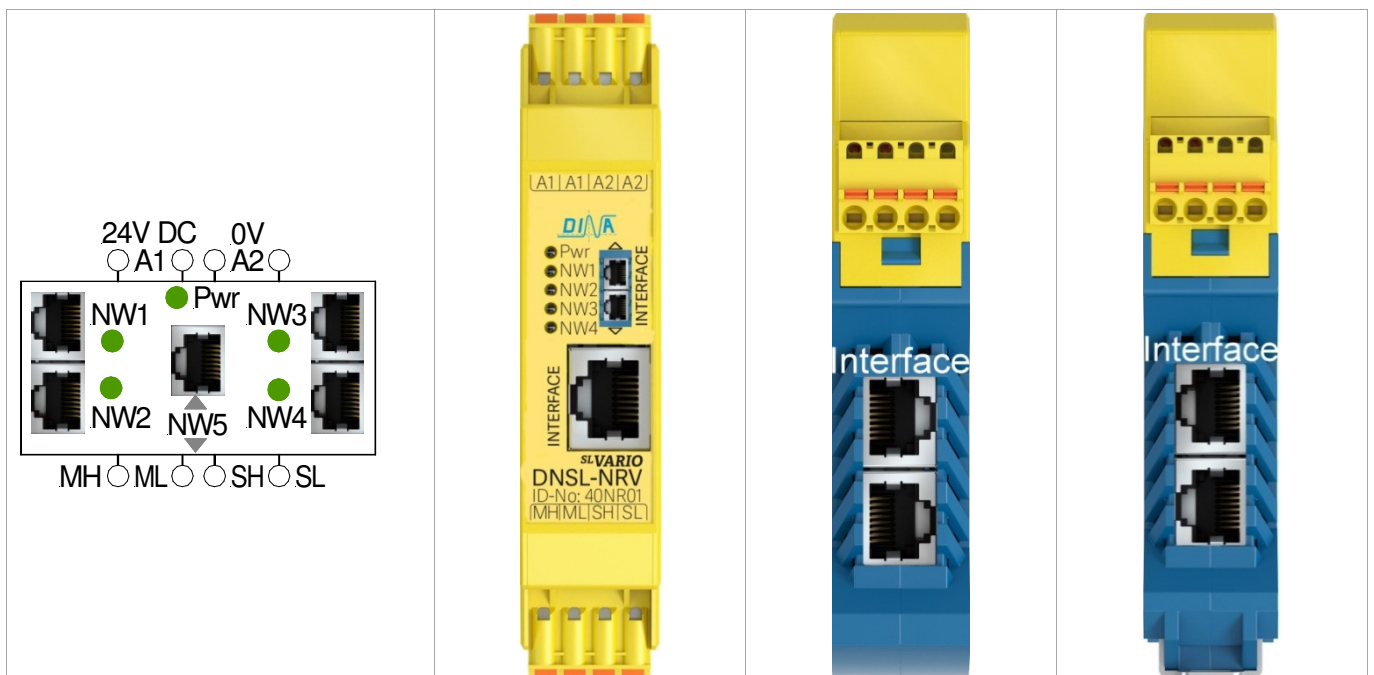

12 Inputs for safety functions

The following table shows modules with their available inputs (I) and in- outputs (IO). These can be used for different safety and not safety relevant functions.

Module DNSL	Inputs																In- Outputs				Designer Symbol
ZMV / ZMVK	I1	I2	I3	I4	I5	I6	I7	I8	I9	I10	I11	I12	I13	I14	I15	I16	IO1	IO2	IO3	IO4	 -Debounce-time- <input type="radio"/> 4ms <input checked="" type="radio"/> 16ms <input type="radio"/> 16ms clocked
INV	I1	I2	I3	I4	I5	I6	I7	I8	I9	I10	I11	I12					IO1	IO2	IO3	IO4	
DSV / DRV	I1	I2	I3	I4	I5	I6	I7	I8													
DSIV / SIV	I1	I2	I3	I4	I5	I6	I7	I8													
IOV / RMV	I1	I2	I3	I4	I5	I6	I7	I8													
FBV / NIV	I1	I2	I3	I4	I5	I6	I7	I8													

FBV: Field bus

12.1 Analogue inputs at the central module

- I1 to I8 safe inputs for safety shutdown mats
- I1 to I8 safe analogue inputs for 0 to 10V
- I1 to I8 safe analogue inputs for 4 to 20mA

12.2 Inputs for function mode selection switch (FMSS) at central module

- 2 FMSS functions are at the central module available.
- Any inputs at SL VARIO and internal designer wiring can be used also.
- One switching position can be selected. No output signal if more or none

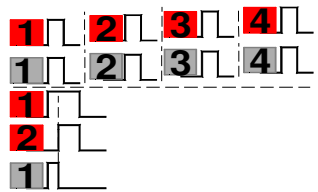
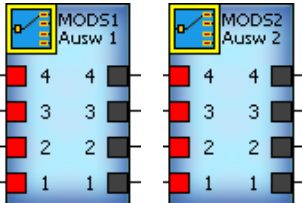
Selection	Diagram	Designer Symbol
1 to 4 : function mode 1 to 4		

12.3 Inputs for Tow-Hand function according EN 574: Type IIIC

Activate both buttons within 500ms.

Response time: < 50ms

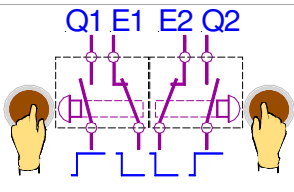
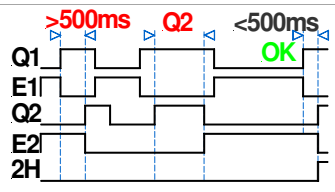
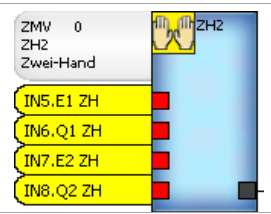
Modules	Inputs	Control	Diagram	Designer Symbol
DNSL-	E1 Q1 E2 Q2			
ZMV / ZMVK	I1 I2 I3 I4			
ZMV / ZMVK	I5 I6 I7 I8			
DRV/ DSV	I1 I2 I3 I4			
INV / IOV	I1 I2 I3 I4			
RMV / FBV	I1 I2 I3 I4			

12.4 Inputs for shut down mats, switch rails and bumpers at central module

- Up to eight short generating shutdown mats, switch rails or bumpers can be monitored safely.
- The sensors have to be connected to I1-I8 accordingly to the schematic down.
- The output SM at the symbol has to be activated via the quit symbol. The quit symbol activate all available shutdown mats.
- Mix configuration of the inputs I1-I8 is possible.
- The reaction time is $\leq 20\text{ms}$
- Power supply: 24V DC +10%, -15% (PLV)
- Safety category 4/ PLe
- For other specifications see general technical data

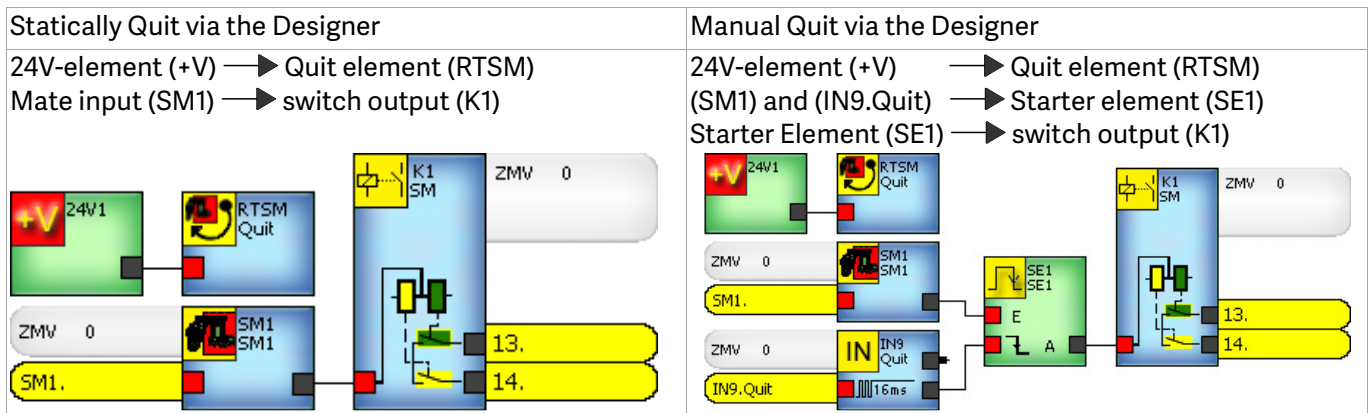
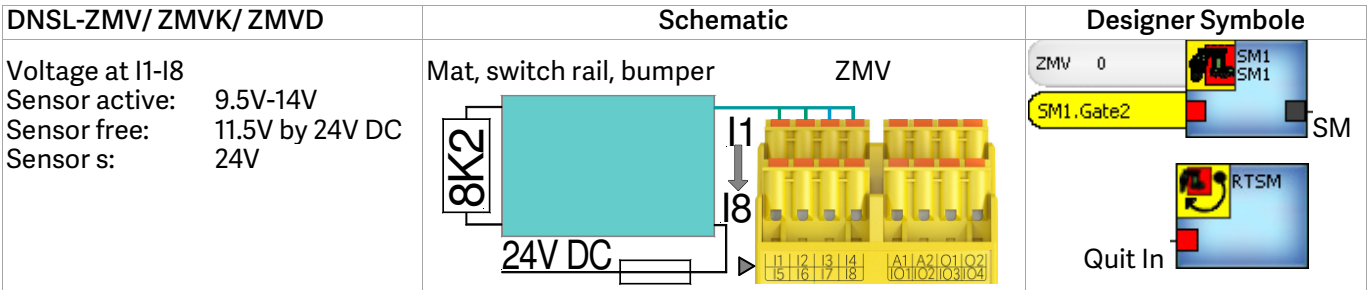

12.5 Important notes with using of shutdown mats, switch rails and bumpers

- The unit may only be installed and operated by those who are qualified electrical engineers or have received sufficient training and are familiar with both these instructions and the current regulations for safety at work and accident prevention.
- At begin of the implementing and in frequently time distance the necessary checks (function, status, rating and arrangement) must be undertaken of the user depending of the signal generator at the safety device.
- The safety function must be required every month if there is performance level (e) and every year if there is PLd is required by using contact outputs.
- The maximal length of the connection wire is depended of the environment and the cross section of the wire. Recommended maximal length 100 m
- The minimal safety distance of the signal generator of the protection device has to be determined according of DIN EN ISO 13855.
- The details in the instruction manual of the used signal generator must be considered and observed.
- Function parameters of the signal generator and control unit must be observed.
- Only signal generators with minimum 500.000 switch cycles respectively switch rails with minimum 11.000 switch cycles can be used.
- The contact load of the switch device outputs is to determinate according part: 17.5, page 38 to arrive the necessary switch cycles.
- The reaction time of the whole system is to consider.
- At the end of the service life the units have to be replaced.
- The replaced units have to be properly disposed.
- Faults and diagnostics via switching status LED (page 12), the online diagnostics via the USB interface at the control unit.

Follow details have to be considered:

Safety regulation and important notes and validation (page 7), general technical data (page 37 and 38), details in the Instruction manual of SL VARIO Designer

12.6 Inputs for Safety circuits (SC) with manual Quit

Safety circuits (SC) / input name (E, Q) / input (I)

Module	SC1			SC3			SC5			SC7		
DNSL-	E11	E12	Q1	E21	E22	Q2	E31	E32	Q3	E41	E42	Q4
ZMV/ ZMVK	I1	I2	I3	I5	I6	I7	I9	I10	I11	I13	I14	I15
INV	I1	I2	I3	I5	I6	I7	I9	I10	I11			
DSV / DRV	I1	I2	I3	I5	I6	I7						
DSIV / SIV	I1	I2	I3	I5	I6	I7						
IOV / RMV	I1	I2	I3	I5	I6	I7						
FBV/ NIV	I1	I2	I3	I5	I6	I7						

Example for emergency stop function with manual Quit

The control happens: parallel static, parallel via clock signal from SL VARIO or static antivalent.

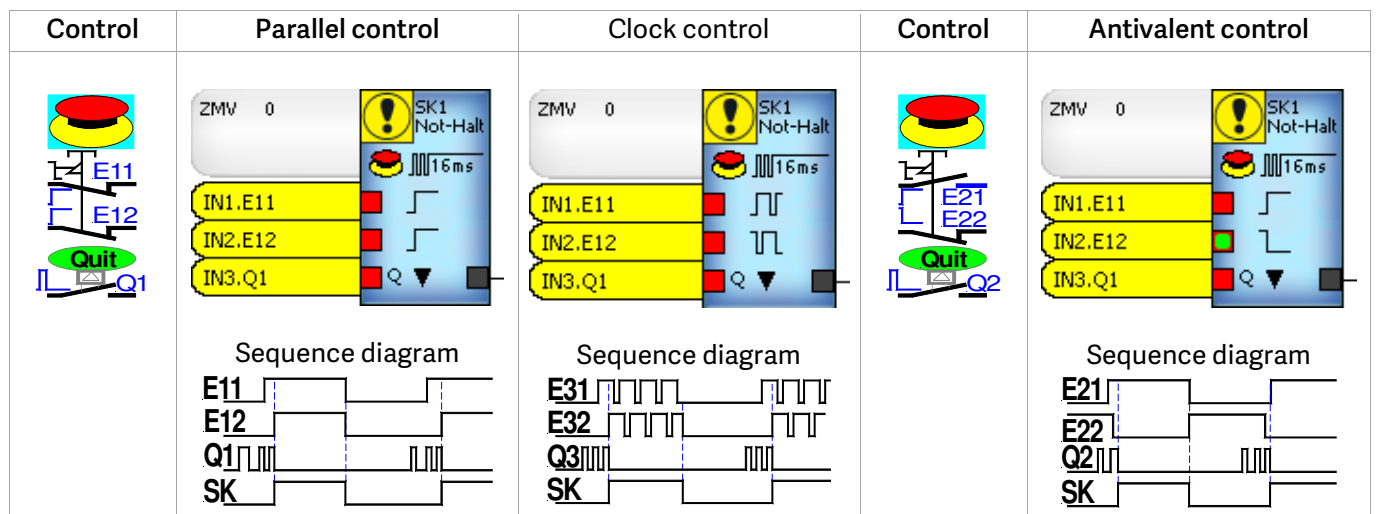

Clock: see SL VARIO outputs for colock.

12.7 Inputs for Safety circuits (SC) with Quit via Q

- The quit signal is created in the Designer and wired to Q-input at the symbol.
- The quit signal happens via a terminal input, input at the field bus or a virtual output.

Safety circuits (SC) / input name (E, Q) / input (I)

Module	SC1			SC2			SC3			SC4			SC5			SC6			SC7			SC8		
	E11	E12	Q1	E21	E22	Q2	E31	E32	Q3	E41	E42	Q4	E51	E52	Q5	E61	E62	Q6	E71	E72	Q7	E81	E82	Q8
DNSL-	I1	I2	Q	I3	I4	Q	I5	I6	Q	I7	I8	Q	I9	I10	Q	I11	I12	Q	I13	I14	Q	I15	I16	Q
ZMV/ ZMVK	I1	I2	Q	I3	I4	Q	I5	I6	Q	I7	I8	Q	I9	I10	Q	I11	I12	Q						
INV	I1	I2	Q	I3	I4	Q	I5	I6	Q	I7	I8	Q	I9	I10	Q	I11	I12	Q						
DSV/ DRV	I1	I2	Q	I3	I4	Q	I5	I6	Q	I7	I8	Q												
DSIV / SIV	I1	I2	Q	I3	I4	Q	I5	I6	Q	I7	I8	Q												
IOV / RMV	I1	I2	Q	I3	I4	Q	I5	I6	Q	I7	I8	Q												
FBV / NIV	I1	I2	Q	I3	I4	Q	I5	I6	Q	I7	I8	Q												

FBV: Field bus

Example for permission function with quit via Q-input

The control happens: parallel static, parallel via clock signal from SL VARIO or static antivalent.

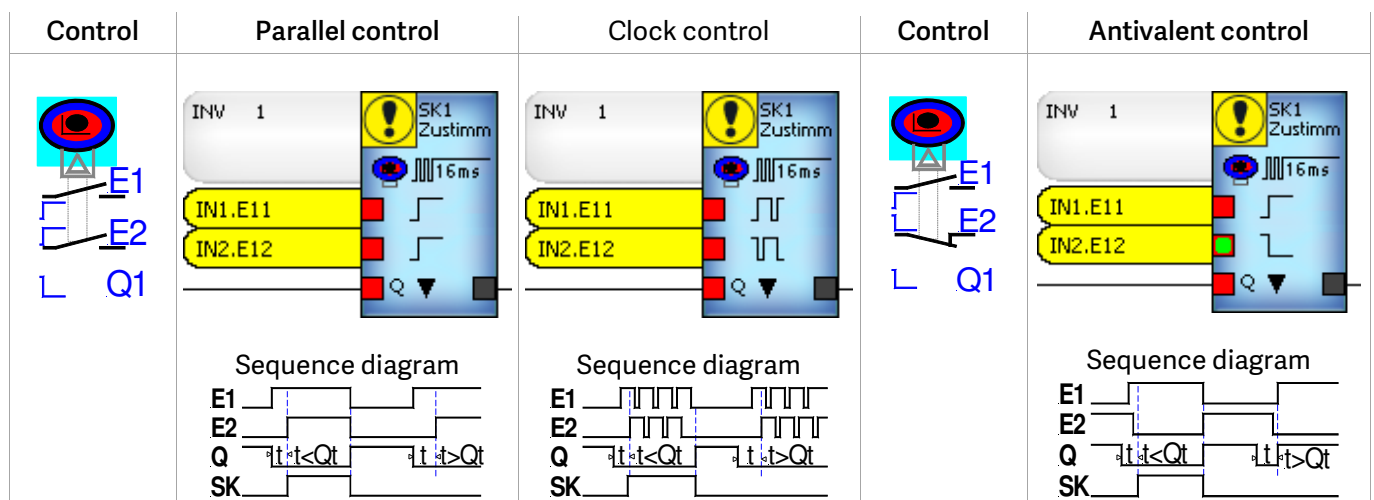

Qt: E1 and E2 have to be activated within 500ms.

Clock: see SL VARIO outputs, clock outputs

12.8 Quit of safety circuit (SC)

- Selection „with falling edge“: The quit signal has to have change \downarrow independent from the source.
- Selection „with High level“: The quit signal can be permanent independent from the source.
- The quit buffer time can be 500ms or no buffer.
- Selection at the Designer for test of SC after Pwr-ON:

Needed: a switch OFF/ ON of the safety circuit

Needless: a switch OFF/ ON of the safety circuit

12.9 Inputs for Safety circuits (SC) without Quit

Safety circuits (SC) / input name (E) / input (I)

Module	SC1		SC2		SC3		SC4		SC5		SC6		SC7		SC8	
	E11	E12	E21	E22	E31	E32	E41	E42	E51	E52	E61	E62	E71	E72	E81	E82
DNSL-	I1	I2	I3	I4	I5	I6	I7	I8	I9	I10	I11	I12	I13	I14	I15	I16
ZMV / ZMVK	I1	I2	I3	I4	I5	I6	I7	I8	I9	I10	I11	I12				
INV	I1	I2	I3	I4	I5	I6	I7	I8								
DSV / DRV	I1	I2	I3	I4	I5	I6	I7	I8								
DSIV / SIV	I1	I2	I3	I4	I5	I6	I7	I8								
IOV / RMV	I1	I2	I3	I4	I5	I6	I7	I8								
FBV / NIV	I1	I2	I3	I4	I5	I6	I7	I8								

FBV: Field bus

Example for safe cover without Quit

The control happens: parallel static, parallel via clock signal from SL VARIO or static antivalent.

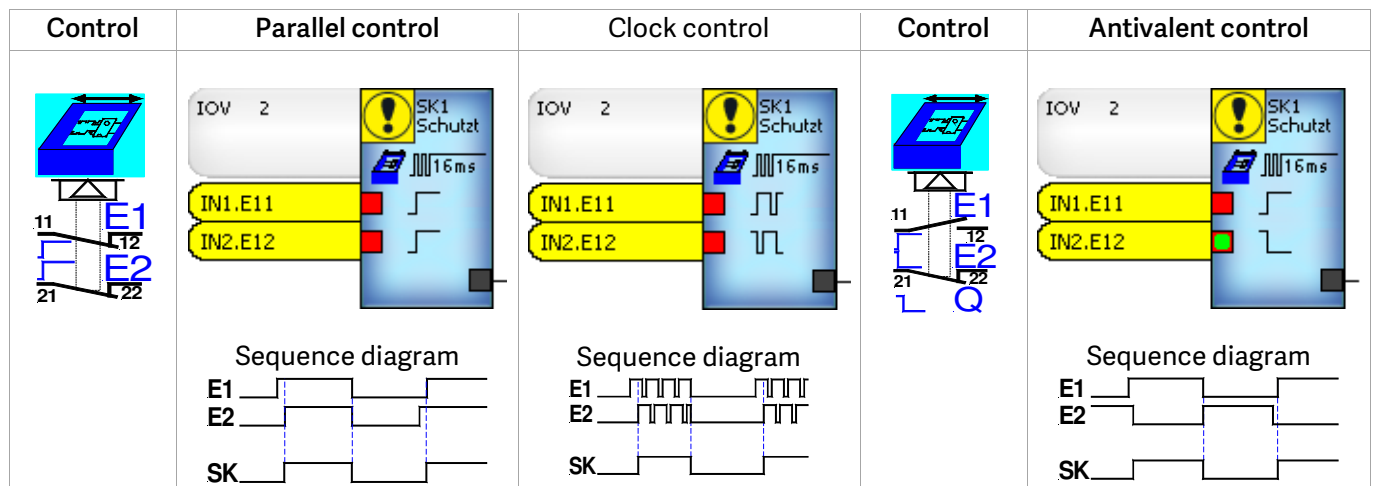

13 Data in- and outputs at the field bus



Module	Input data	Designer Symbol	Output data	Designer Symbol
DNSL-COV DNSL-DPV DNSL-ECV DNSL-EPV DNSL-MOV DNSL-PLV DNSL-PNV	FBI1.1 - FBI1.8 ▼ FBI4.1 - FBI4.8		FBO1.1 - FBO1.8 ▼ FBO16.1 - FBO16.8	

14 Inputs for standstill and speed monitoring

14.1 Inputs for standstill and speed monitoring at the central module

Example 1:

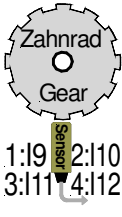
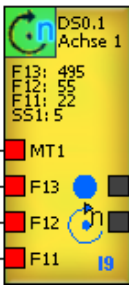
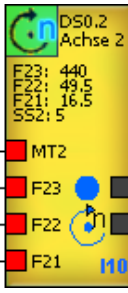
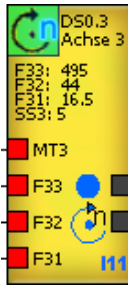
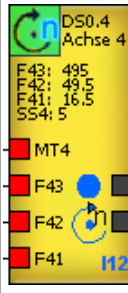



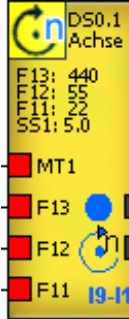
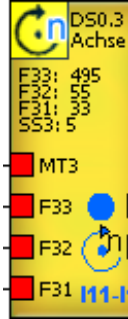
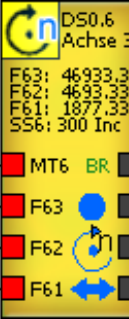

- 4 one-channel monitoring each with one sensor at the input I9, I10, I11, I12, (20-26V/ 500Hz)
- Monitoring of standstill and speed in different operating modes.
- One safe monitoring with a HTL incremental measuring system at the inputs I13 – I16, (20-26V/ 50KHz)
- Monitoring of standstill, speed, position, direction and break in different operating modes is possible. ID-No.: 40ZM03, 40ZM23, 40ZM04, 40ZM 24 only
- One-channel symbol is the left corner green, safe yellow

Sensor	Function mode	One-Channel monitoring				Measuring system	Safe monitoring
1 – 4 	Automatic mode not monitored Automatic mode Semi-automatic mode Tool-setting mode	1 	2 	3 	4 	5 Signals +A I13 +B I14 -A I15 -B I16 20 – 26V ≤ 50KHz	5 

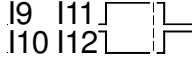
Example 2

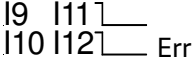
- 3 safe standstill and speed monitoring
- One safe monitoring with 2 sensors at I9 and I10, (20-26V/ 500Hz)
- One safe monitoring with 2 sensors at I11 and I12, (20-26V/ 500Hz)
- Monitoring of standstill and speed in different operating modes is possible
- Mix one-channel and safe monitoring is possible.
- One safe monitoring using a HTL incremental measurement system (+A I13, +B I14, -A I15, -B I16), (20-26V/ 50KHz), ID-No.: 40ZM03, 40ZM23, 40ZM04, 40ZM 24 only
- Monitoring of standstill, speed, position, direction and break in different operating modes is possible

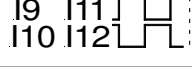
Sensor	Function mode	Safe monitoring		Measuring system	Safe monitoring
1 / 2 	Automatic mode not monitored Automatic mode Semi-automatic mode Tool-setting mode	1 	2 	3 Signals +A I13 +B I14 -A I15 -B I16 20 – 26V ≤ 50KHz	3 

Signals during standstill	I9 I11  I10 I12  OK	I9 I11  I10 I12  Error
Signals during movement ≥5≤500Hz	I9 I11  I10 I12 	

14.2 Requirements for the sensors for safe monitoring

- Two sensors for every monitoring
- At the cogwheel one sensor opposite to cog other to gap
- During standstill at least one sensor has 24V signal.
- The function of the sensors is permanently monitored.

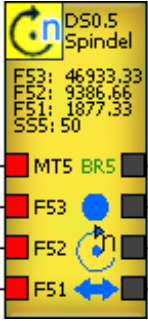
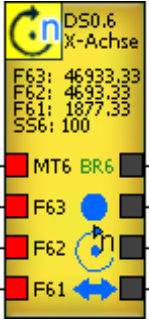

Example 3

- One safe monitoring via an incremental HTL measuring system (+A ► I9, +B ► I10, -A ► I11 and -B ► I12)
- One safe monitoring via an incremental HTL measuring system (+A ► I13, +B ► I14, -A ► I15 and -B ► I16)
- Standstill, position, direction, speed, and break can be monitored in different operating modes, ID-No.: 40ZM03, 40ZM23, 40ZM04, 40ZM 24 only

Function mode	Safe monitoring 1	Measuring system signals	Safe monitoring 2
Automatic mode not monitored		1 +A I9 +B I10 -A I11 -B I12 2 +A I13 +B I14 -A I15 -B I16 20 – 26V/ ≤ 50KHz	
Automatic mode			
Semi-automatic mode			
Tool-setting mode			

14.3 Input for safe standstill and speed monitoring at DNSL-DSV and DSV2

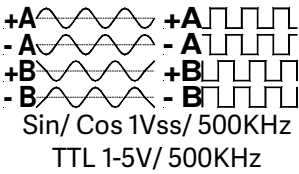
- Two monitoring are possible.
- For every monitoring an incremental measuring system sinus / cosine or TTL signals is necessary.
- Standstill, position, direction, break and speed monitoring in different operating modes are possible.

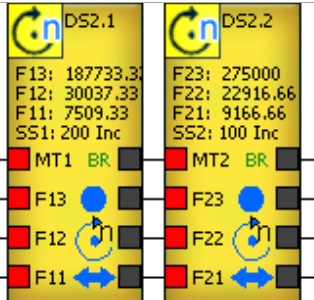
Measuring system inputs	Usage example	Function mode	Designer Symbols
Encoder 1 Encoder 2  Sin/ Cos 1Vss/ 500KHz TTL 1-5V/ 500KHz		Automatic mode not monitored Automatic mode Semi-automatic mode Tool-setting mode	

14.4 Requirements of the incremental measuring system

Standard Sin / Cos or TTL measuring system <ul style="list-style-type: none"> • Amplitude 1Vpp sinus / cosine or TTL • Encoder frequency ≤ 500KHz • 2 tracks, 90° phase offset, per track 2 signals, 180° phase shifted • A direct connection between motion monitoring and measuring system is required 	Standard HTL measuring system via cable adapter <ul style="list-style-type: none"> • Amplitude 18 to 26V square wave. • Encoder frequency ≤ 500KHz • 2 tracks, 90° phase offset, per track 2 signals, 180° phase shifted • System without negated signals is possible. • A direct wire connection between motion monitoring and measuring system is required.
-----------------------------------------------------------------------------------------------------------------------------------------------------------------------------------------------------------------------------------------------------------------------------------------------------------------------------------------------------------	-------------------------------------------------------------------------------------------------------------------------------------------------------------------------------------------------------------------------------------------------------------------------------------------------------------------------------------------------------------------------------------------------------------------------

14.5 Two sensors measuring system with DNSL-DSV

- For every monitoring 2 positive switching sensors with antivalent signals.
- The signals of the sensors have to be connected to the RJ45 plugs at the monitoring module.
- The connection happens via two cable adapters type DNRJ45 HTL-SL.
- For the monitoring of the direction a time pitch between the impulse edges of both signals is necessary for the whole speed range. This must be considered for the mounting of the sensors.
- Time pitch and duty cycle value are not relevant.
- After power-on the LR-signal is indefinite.
- Usage of sensors with one output is possible. Here is a monitoring of the direction not possible.

14.6 Ramp monitoring with DNSL-DSV and DSV2

- The output (SAR BRx) at the symbol is to use for the ramp monitoring of an axle.
- The speed reduction in rotation/s² respectively meter/s² and the sample rate is adjustable at the Designer.
- The sample rate is selectable 10-150ms in 10ms steps.
- With the selection (---) is the output BRx low.
- During speed reduction ≥ selection is BRx high.
- During speed reduction < selection is BRx low.
- Outputs at SL VARIO can be triggered via SAR outputs.

14.7 Inputs for standstill and speed monitoring at DNSL-DSIV

- Two monitoring are possible.
- For first monitoring an incremental measuring system with sin/ cos 1Vss or TTL signals is used.
- For the second monitoring a SSI interface measuring system is necessary.
- A comparator function is available between the first and the second monitoring.
- Standstill, position, direction, break and speed monitoring in different operating modes are possible.
- For ramp monitoring see Designer instruction manual.

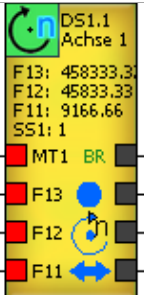
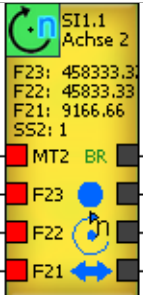
Measuring inputs		Usage example	Function mode	Designer Symbole
Encoder 1	Encoder 2		Automatic mode not monitored Automatic mode Semi-automatic mode Tool-setting mode	
+A -A +B -B	SSI			

14.8 Input for standstill and speed monitoring at DNSL-DRV

- Two monitoring with resolver measuring systems.
- For every monitoring one system is necessary.
- Standstill, position, direction, break and speed monitoring in different operating modes are possible.

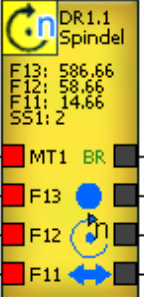
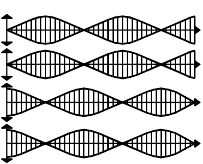
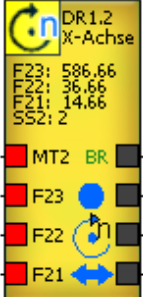
Measuring inputs		Usage example	Function mode	Designer Symbols
Resolver 1	Resolver 2		Automatic mode not monitored Automatic mode Semi-automatic mode Tool-setting mode	
 1 - 10V ≤ 1200Hz				



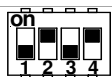
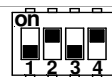
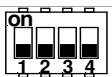
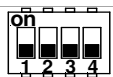
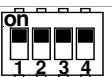
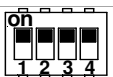
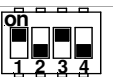
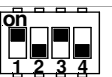

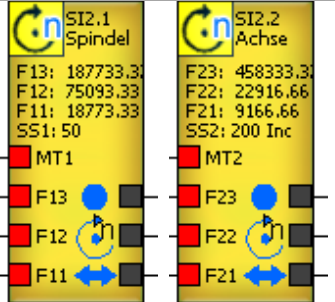

Setting of the resolver amplitude at DNSL-DRV
The setting of both DIP switches is identical.

Amplitude	1-2Vss		2-4Vss		4-8Vss		8-10Vss	
Adjustment								



14.9 Inputs for standstill and speed monitoring at DNSL-SIV

- Two monitoring with SSI interface measuring system.
- For every monitoring one system is necessary.
- Standstill, position, direction, break and speed monitoring in different operating modes are possible.

Measuring inputs		Usage example	Function mode	Designer Symbole
Encoder 1	Encoder 2		Automatic mode not monitored	
SSI	SSI		Automatic mode	
			Semi-automatic mode	
			Tool-setting mode	

Symbol functions of the inputs		Symbol functions for outputs	
 Fxx	Fx1: Tool-setting function mode	 BRx	Ramp monitoring (SAR)
	Fx2: Semi-automatic function mode	 BRx	Standstill monitoring (SOS)
	Fx3: Automatic function mode	 BRx	Speed monitoring (SSM)
 MTx	Mute of the Automatic function mode	 BRx	Direction monitoring (SDI)

14.10 Direction monitoring with DSV, DSV2, DSIV, DRV und SIV

- The virtual outputs (SDI  ) at the Designer can be used to monitor the direction of an axle.
- SDI has high signal during standstill and while sinus is advanced. Low signal if cosine is advanced.
- The preferred direction can be selected via hardware inputs and logic elements.

14.11 Quit of speed monitoring

- After an over speed the output (SSM) has a high signal.
- After a quit via the input ( RTDS) is a high signal at the output (SSM) if the actual speed is lower than the selected.
- SSM changes to low signal with movement if no operating mode is selected.
- Selection of the operating modes happens via hardware terminal.
- To control the terminals permission-switch unit can be used as inching mode, permission key or safety cover contact

14.12 DNCO function to monitor the Peripheral speed

16 monitored speeds				64 monitored speeds					
I1	I2	I3	I4	I1	I2	I3	I4	I5	I6

- The DNCO function by DNSL-DSV, DRV and ZMV enables the monitoring of the peripheral speeds of machined parts or tools.
- 16 different speeds for two monitoring and for every operating mode or
- 64 different speeds for two monitoring during the automatic mode.
- The speeds can be entered in two frequency tables at the Designer.
- The selection of the monitored speeds happens via the bit code wiring of the terminal inputs.
- 4 inputs enable to monitor 16 speeds in all operating modes. For up to 64 speeds 6 terminal inputs are required.
- The DNCO1 unit can be used to set these inputs.



14.13 DNCO1 connection schematic

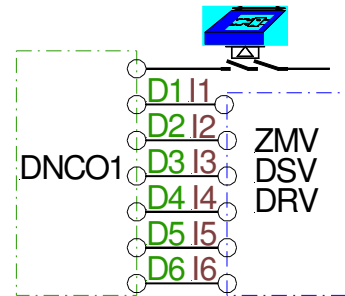

14.14 Selection of DNCO-Multiplexer

- The configuration requires logic operations to select the frequencies in the table in the Designer.
- The logic operations can be process-related. In this case no terminal inputs are necessary.
- A DNCO-multiplexer is available for every frequency table. 16 frequencies can be selected via a DNCO- multiplexer.
- The cell 00 in the table is selected if all inputs are not activated.
- The cells 01 to 15 are selectable via the input 1 to 15 at the DNCO-multiplexer.
- The first monitoring is paired with DNCO1 the second with DNCO2

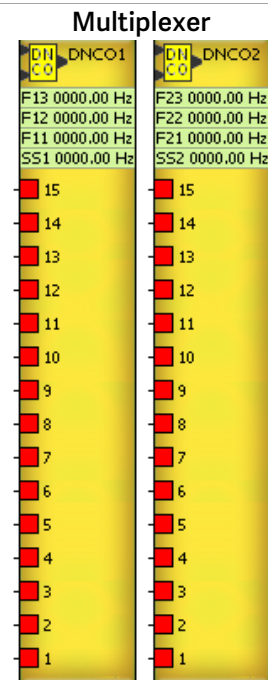





15 Cable adapter DNDA

The DNDA is used as an interconnection between the measuring system of the axle and the speed monitoring system. It is available for all CNC variations. See instruction manual „Cable adapter“.



DNRJ45-HTL-SL is to use with incremental Measuring system with HTL-signals

DNRJ45 HTL-SL	Wire colours
 ID-No.: 95RJ20	 : 0V  : A  : A/  : B  : B/

16 Outputs at SL VARIO

Short-circuit-proof positive switching semiconductor outputs

DNSL-		Switch current	P-Level	Description
ZMV ZMVK	A1	1A, Σ 3A	PLe	6 safe outputs O1, O2 monitored current
ZMV ZMVK	A1	0.1A Σ 0.4A	PLe	4 clock outputs 4 safe outputs 4 safe digital inputs
DSV DRV	P	0.25A Σ 0.4A	PLc	2 clock or switching outputs
DSV DRV	P	1A Σ 2.5A	PLe	5 safe outputs O1, O4 also clock outputs
SIV NIV	P	1A Σ 2A	PLd	4 safe outputs
INV	A1	0.1A	PLe	4 safe or clock outputs
IOV DSIV DSV	P	1A Σ 3,5A	PLe	7 safe outputs O1-O4 also clock outputs

Safe contact outputs

DNSL-		Switch current	P-Level	Description
ZMV ZMVD	K1 13 14 K2 23 24	\geq 10mA \leq 6A Σ K1+K2: 6A	PLe	2 safe NO contact DC13: 24V/ 2A AC15: 230V/ 3A 40ZM31/ 32 not available
ZMVK	K3 33 34 43 44 K4 53 54 63 64 K5 73 74 83 84 K6 93 94 103 104	\geq 10mA \leq 6A Σ K3+K4: 6A Σ K5+K6: 6A	PLe	Output extension 4 outputs each 2 safe NO contacts DC13: 24V/ 5A
DNSL-RMV	K1 13 14 23 24 K2 33 34 43 44	\geq 10mA \leq 6A Σ K1+K2: 6A	PLe	2 outputs each 2 safe NO contacts DC13: 24V/ 4A AC15: 230V/ 3A

Designer Symbols

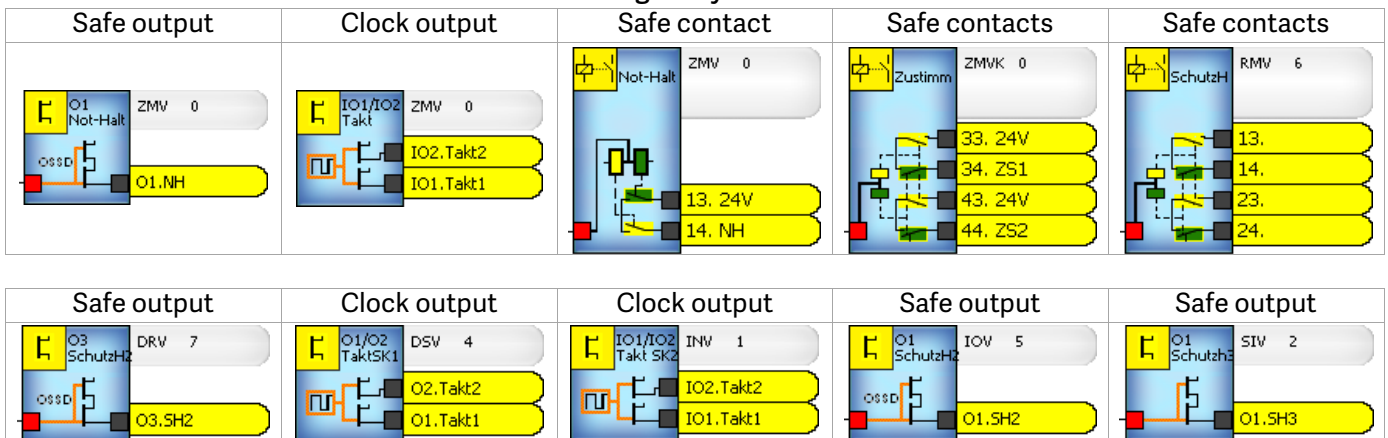

The configuration of the outputs happens at Designer.

A lot of diagnostics functions are available. This is useful for the setting-up operation and debugging.

17 General technical data

17.1 Electrical characteristics

Operation voltage via A1, A2 at ZMV, ZMVK	24V DC, -15% + 10% for all modules, ≤10% Ripple
Input current at A1	≤ 4A / internal fuse: 6A

DNSL-	ZMV	ZMVA	ZMVD	ZMVK	DSV	DSV2	DSIV	DRV
Power consumption in W	2.9	3.0	3.0	7.7	2.5	2.5	2.5	2.5
Wight in g	350	450	450	570	130	130		130

DNSL-	SIV	INV	IOV	CMV	NIV	NRV	RMV	Feld Bus
Power consumption in W	2.2	1.7	2.2	0.5	2.2	0.5	4.8	1.0
Wight in g	130	130	130	130	130	130	140	130

17.2 Environment conditions

Operating temperature: -10 +55°C	Storage temperature: -40 +85°C
Vibration resistance 3 axle	Sinus 10–55Hz, 0,35mm, 10 cycles, 1 octave /min
Shock resistance 3 axle for output relay	≤ 5g, 11ms
Max. cable cross section	1 x (0,2-1,0mm ²) with wire end sleeve
Terminal	Spring load clamps, pluggable
Connection wire	60/75°C copper only
Housing material	Polyamide PA unreinforced
Protection class	Installation in a closed cabinet with ≥ IP 54
Voltage at the inputs by shutdown mat	I1 to I8: 9.5 to 14V, 11.5V with 24V shutdown mat voltage
Reaction time by shutdown mat	< 20ms
Voltage at the inputs	24V DC -15%, + 10%
Input current consumption	Max. 4mA
Input voltage terminal(P) at DSV, DRV, SIV, IOV, NIV	24V DC -15% + 10%
Input current terminal(P) at DSV, DRV, SIV, IOV, NIV	≤ 4A
Input frequency at I9 – I12 at central module	≤ 1200Hz HTL-signals via as example proximity switches
Input frequency at I9 – I16 at central module	≤ 50KHz HTL-signals via incremental measuring system
Input frequency Encoder 1 and 2 at DNSL-DSV	≤ 500KHz Sin / Cos 1Vpp or TTL signals
Input frequency resolver 1 and 2 at DNSL-DRV	≤ 1200Hz Sin/ Cos 1 to 10Vpp
Input signals at DNSL-SIV	SSI interface signals
Accuracy of the analogue inputs	± 3% of the maximal input value over -10 to +60°C
Input impedance of the analogue inputs	With 4-20mA ca. 500Ω, with 0-10V > 5KΩ

Remark: current inputs (4-20mA) can be destroyed wit input voltage >12V

17.3 Technical data of the Semiconductor outputs

Technical data Semiconductor outputs	ZMV/ ZMVK		DSV, DRV		INV	IOV	NIV, SIV
Outputs	IO1 - IO4	O1 – O6	O1, O2	O3 – O7	IO1 - IO4	O1 – O7	O1 – O4
Performance level	PLe	PLe	PLc	PLe	PLe	PLe	PLd
Schematic of outputs							
Switch and continuous current Ω / L	0,1A	1A	0,25A	1A	100mA	1A	1A
Sum of Switch/continuous current Ω/L	0,4	3A	0,4A	2,5A	0.4A	3,5A	2A
Minimal Switch current Ω / L	1mA	1mA	1mA	1mA	1mA	1mA	1mA

- The power supply of the semiconductor outputs will be disconnected if the terminal A2 is not connected to 0V. Therefor residual voltage at the output loads is not possible.
- All semiconductor outputs are short circuit and overload proof.
- Every output has a recovery diode.

17.4 Technical data of the contact outputs

Technical data contact outputs	DNSL-ZMV/ ZMVK	DNSL-ZMVK	DNSL-RMV
Outputs	K1, K2	K3 – K6	K1, K2
outputs schematic, Performance level: PLe			
Minimum switch current	10mA	10mA	10mA
switch current, 0,1Hz cycles according to DIN EN 60947-4-1/ EN 60947-5-1	DC1: 24V/6A DC13: 24V/2A	DC1: 24V/6A DC13: 24V/5A	DC1: 24V/6A DC13: 24V/4A
switch current according to DIN EN 60947-4-1/ EN 60947-5-1	AC1:250V/6A AC15: 230V/3A		AC1:250V/6A AC15: 230V/3A
Sum of the switch and continuous current	≤ 4A	K3, K4:≤ 6A, K5, K6:≤6A	K1: ≤ 4A, K2: ≤ 4A
Electrical life DC13: 24V/ 1A	1.5x10 ⁹	1x10 ⁹	9x10 ⁸
Electrical life DC13: 24V/ 4A	10 ⁴	4x10 ⁴	7x10 ⁴
Electrical life AC15: 230V/ 1A	2x10 ⁹		7x10 ⁹
Electrical life AC15: 230V/ 2A			5x10 ⁹
Mechanical life	> 50x10 ⁶	> 10 ⁷	> 40 x 10 ⁶
Maxim switch cycles DC13: 4A	360 cycles/h	360 cycles /h	360 cycles /h
Maxim switch cycles AC15: 3A	360 cycles /h		360 cycles /h
Contact fuse	6A slow	6A slow	6A slow
Short circuit strength: Automat	200A/ B6		200A/ B6
safety fuse gG	800A/ 6AgG	1000A SCPD 6A	800A/ 6AgG
Rated insulation voltage	250V AC		250V AC
Impulse withstand voltage	4KV		4KV
Use in pollution degree 2 environment.			
Reaction time, drop out time	15mS/12mS	10mS/ 3mS	10mS
AC1: control of none or low inductive load, AC voltage AC15: control of electro-magnetically load, AC voltage		DC1: control of none or low inductive load, DC voltage DC13: control of electro-magnetically load, DC voltage	

17.5 Electrical life of the contact outputs

260 Work days / year/ 8h work time/ day/ switch voltage 24V DC

Modules	DNSL-ZMV, ZMVK: K1, K2					DNSL-ZMVK: K3-K6					DNSL-RMV: K1,K2					Jahre
	DC1	DC1	DC1	DC13	DC13	DC1	DC1	DC1	DC13	DC1	DC1	DC1	DC1	DC13	DC13	
Last Art	1.0A	4.0A	6.0A	1.0A	4A	1.0A	4.0A	6.0A	1.0A	4.0A	1.0A	4.0A	6.0A	1.0A	4.0A	
Schaltstrom	384	192	153	15	1	144	36	29	15	5	769	192	96	91	67	5
Schaltspiele/ Stunde	192	96	76	7	0.5	77	17	14	7	2	384	96	48	45	33	10
	96	48	38	3.6	0.25	38	8	7	3.6	1	192	48	24	23	17	20

260 Work days / year/ 8h work time/ day/ switch voltage 230V AC

Modules	DNSL-ZMV, ZMVK: K1, K2					DNSL-ZMVK: K3-K6					DNSL-RMV: K1,K2					Jahre
	AC1	AC1	AC1	AC15	AC15	AC1	AC1	AC1	AC15	AC15	AC1	AC1	AC1	AC15	AC15	
Last Art	0.5A	1.0A	3.0A	0.5A	1.0A						0.5A	1A	3.0A	0.5A	2A	
Schaltstrom	192	96	20	288	20						174	96	20	116	48	5
Schaltspiele/ Stunde	96	48	10	144	10						87	48	10	58	24	10
	48	24	5	72	5						44	24	15	28	12	20

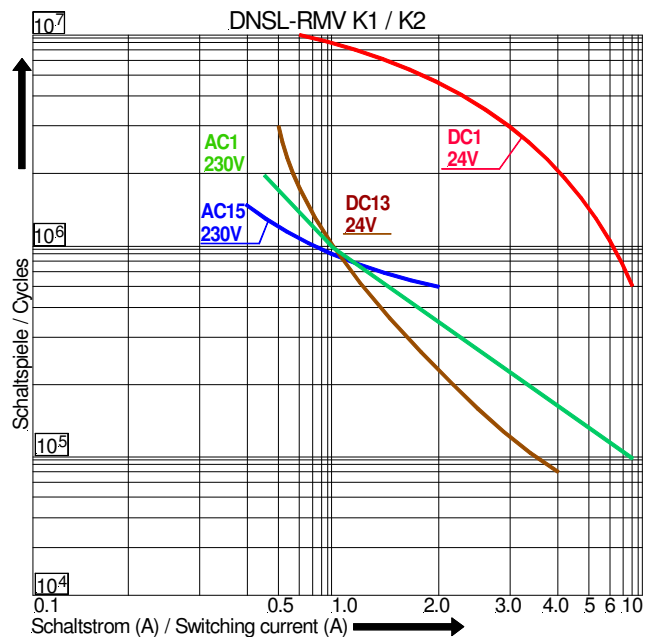
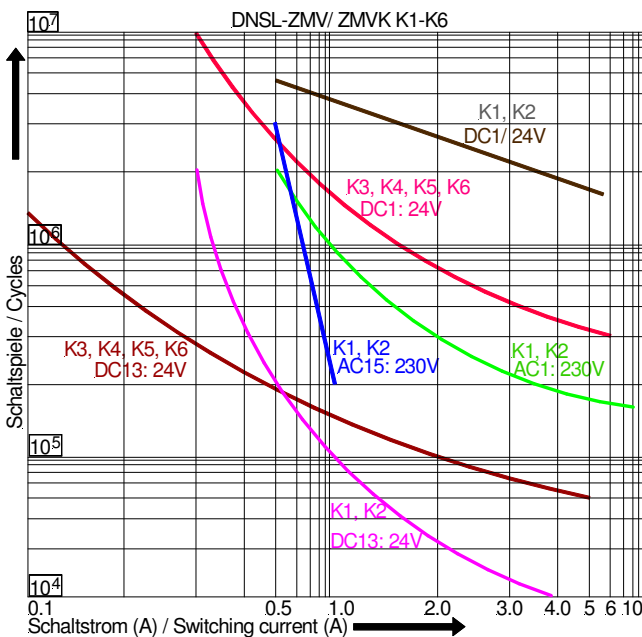

18 Dimensions

DNSL-ZMV 45 mm	DNSL-ZMVA, DNSL-ZMVK: 67.5 DNSL-ZMVD: 67.5 mm or 90 mm	Others 22.5 mm	Others 22.5 mm	Others 22.5 mm
				

DNSL-ZMVD: 67.5 mm with 4 standstill and speed monitoring
 90.0 mm with 8 standstill and speed monitoring

18.1 Fitting and remove

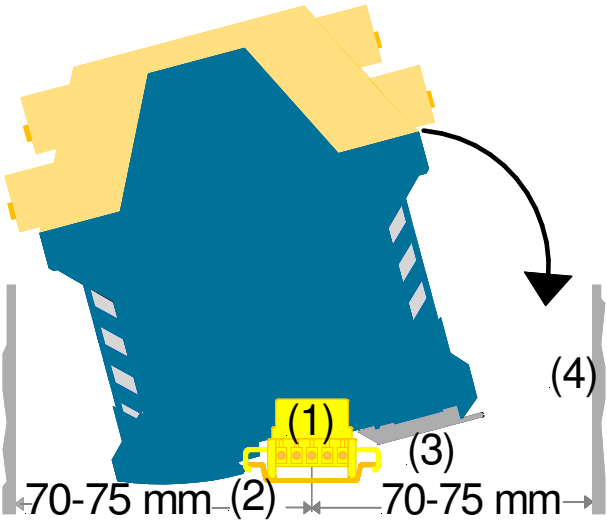
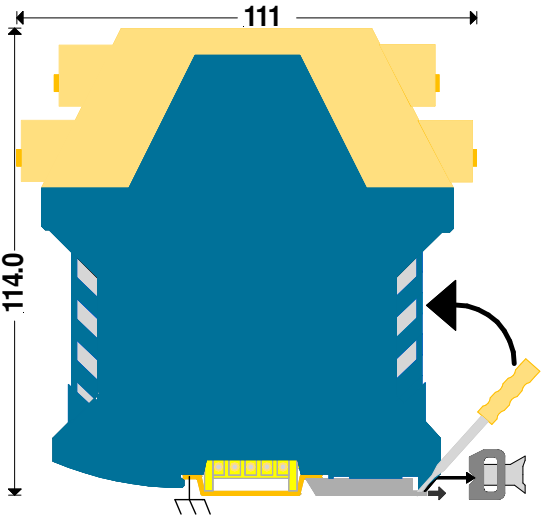
<p>Fitting: Plug bus connector at the cap rail. Hook the module up side at the cap rail. Push it down.</p>	<p>Remove: Screwdriver to unlock the module from the cap rail. Move the module to the up direction and take it out.</p>
 <p style="text-align: center;">Cable channel distance</p>	 <p style="text-align: center;">⚡ Grounding via DIN rail</p>

- (1) Bus connector
- (2) Cap rail
- (3) Locking feeder
- (4) Cable channel



DINA Elektronik GmbH
Esslinger Str. 84
D72649 Wolfschlugen
Phone +49 7022 95 17 0
Fax +49 7022 95 17 700
info@dina.de
www.dina.de