



SQM-160TM

Multi-Film Rate/Thickness Monitor

PN 074-511-P1E



O P E R A T I N G M A N U A L

SQM-160TM

Multi-Film Rate/Thickness Monitor

PN 074-511-P1E



www.inficon.com reachus@inficon.com

©2015 INFICON

Trademarks

The trademarks of the products mentioned in this manual are held by the companies that produce them.

INFICON® is a trademark of INFICON Inc.

SQM-160™ and INFICON® are trademarks of INFICON GmbH.

Visual Basic®, Windows®, and Excel® are registered trademarks of Microsoft Corporation.

Java® is a registered trademarks of Oracle and/or its affiliates.

Inconel® is a registered trademark of Inco Alloys International, Huntington, WV.

All other brand and product names are trademarks or registered trademarks of their respective companies.

Disclaimer

The information contained in this manual is believed to be accurate and reliable. However, INFICON assumes no responsibility for its use and shall not be liable for any special, incidental, or consequential damages related to the use of this product.

Due to our continuing program of product improvements, specifications are subject to change without notice.

Copyright

©2015 All rights reserved.

Reproduction or adaptation of any part of this document without permission is unlawful.



**DECLARATION
OF
CONFORMITY**

This is to certify that this equipment, designed and manufactured by:

**INFICON Inc.
Two Technology Place
East Syracuse, NY 13057
USA**

Meets the essential safety requirements of the European Union and is placed on the market accordingly. It has been constructed in accordance with good engineering practice in safety matters in force in the Community and does not endanger the safety of persons, domestic animals or property when properly installed and maintained and used in applications for which it was made.

Equipment Description: SQM-160 Rate / Thickness Monitor (including all options)

Applicable Directives: 2014/35/EU (LVD)
2014/30/EU (General EMC)
2011/65/EU (RoHS2)

Applicable Standards:

Safety:	EN 61010-1: 2010 Safety Requirements for Electrical Equipment For Measurement, Control, And Laboratory Use. PART 1: General Requirements
Emissions:	EN 61326-1: 2013 (Radiated & Conducted Emissions) (EMC – Measurement, Control & Laboratory Equipment) CISPR 11/EN 55011 Edition 2009-12 Emission standard for industrial, scientific, and medical (ISM) radio RF equipment FCC Part 18 Class A emissions requirement (USA)
Immunity:	EN 61326-1: 2013 (Industrial EMC Environments) (EMC – Measurement, Control & Laboratory Equipment)
RoHS2:	Fully Compliant

CE Implementation Date: January 2003 (Revised August, 2015)

Authorized Representative: Steven Schill

Thin Film Business Line Manager
INFICON, Inc.

Warranty

WARRANTY AND LIABILITY - LIMITATION: Seller warrants the products manufactured by it, or by an affiliated company and sold by it, and described on the reverse hereof, to be, for the period of warranty coverage specified below, free from defects of materials or workmanship under normal proper use and service. The period of warranty coverage is specified for the respective products in the respective Seller instruction manuals for those products but shall not be less than two (2) years from the date of shipment thereof by Seller. Seller's liability under this warranty is limited to such of the above products or parts thereof as are returned, transportation prepaid, to Seller's plant, not later than thirty (30) days after the expiration of the period of warranty coverage in respect thereof and are found by Seller's examination to have failed to function properly because of defective workmanship or materials and not because of improper installation or misuse and is limited to, at Seller's election, either (a) repairing and returning the product or part thereof, or (b) furnishing a replacement product or part thereof, transportation prepaid by Seller in either case. In the event Buyer discovers or learns that a product does not conform to warranty, Buyer shall immediately notify Seller in writing of such non-conformity, specifying in reasonable detail the nature of such non-conformity. If Seller is not provided with such written notification, Seller shall not be liable for any further damages which could have been avoided if Seller had been provided with immediate written notification.

THIS WARRANTY IS MADE AND ACCEPTED IN LIEU OF ALL OTHER WARRANTIES, EXPRESS OR IMPLIED, WHETHER OF MERCHANTABILITY OR OF FITNESS FOR A PARTICULAR PURPOSE OR OTHERWISE, AS BUYER'S EXCLUSIVE REMEDY FOR ANY DEFECTS IN THE PRODUCTS TO BE SOLD HEREUNDER. All other obligations and liabilities of Seller, whether in contract or tort (including negligence) or otherwise, are expressly EXCLUDED. In no event shall Seller be liable for any costs, expenses or damages, whether direct or indirect, special, incidental, consequential, or other, on any claim of any defective product, in excess of the price paid by Buyer for the product plus return transportation charges prepaid.

No warranty is made by Seller of any Seller product which has been installed, used or operated contrary to Seller's written instruction manual or which has been subjected to misuse, negligence or accident or has been repaired or altered by anyone other than Seller or which has been used in a manner or for a purpose for which the Seller product was not designed nor against any defects due to plans or instructions supplied to Seller by or for Buyer.

This manual is intended for private use by INFICON® Inc. and its customers. Contact INFICON before reproducing its contents.

NOTE: These instructions do not provide for every contingency that may arise in connection with the installation, operation or maintenance of this equipment. Should you require further assistance, please contact INFICON.



Table Of Contents

Cover Page
 Title Page
 Trademarks
 Disclaimer
 Copyright
 Declaration Of Conformity
 Warranty

Chapter 1

Introduction and Specifications

1.1	Introduction	1-1
1.1.1	Related Manuals	1-2
1.2	Instrument Safety	1-2
1.2.1	Definition of Notes, Cautions, and Warnings	1-2
1.2.2	General Safety Information	1-3
1.2.3	Earth Ground	1-4
1.3	How To Contact INFICON	1-4
1.3.1	Returning SQM-160	1-5
1.4	Specifications	1-5
1.4.1	Measurement	1-5
1.4.2	Film Parameters	1-6
1.4.3	System Parameters	1-6
1.4.4	Digital I/O	1-7
1.4.5	General Specifications	1-7
1.5	Unpacking and Inspection	1-8
1.6	Configurations and Accessories	1-8
1.6.1	SQM-160 Configurations	1-8
1.6.2	Accessories	1-9
1.6.2.1	Oscillator Kits	1-9
1.6.2.2	Rack Mounting Options	1-9
1.6.2.3	Sensors	1-10

Chapter 2

Installation

2.1	Installation Requirements	2-1
2.1.1	Parts Requirements	2-1

2.1.2	Ground Requirements	2-2
2.1.3	Establishing Earth Ground	2-3
2.2	Rack Mounting Procedure	2-3
2.2.1	Full Rack Extender	2-3
2.2.1.1	Inventory	2-3
2.2.1.2	Installation	2-4
2.2.2	Rack Adapter	2-8
2.2.2.1	Inventory	2-8
2.2.2.2	Installation	2-8
2.3	Rear Panel Interfaces	2-11
2.4	System Connections	2-12
2.4.1	Sensor Connections	2-13
2.5	I/O Connections	2-14

Chapter 3

Operation

3.1	Introduction	3-1
3.2	Front Panel Controls	3-1
3.3	Menu Selection	3-3
3.4	Film Menu	3-4
3.5	System Menu	3-6
3.6	Sensor Selection	3-9
3.7	Sensor Frequency	3-10
3.8	Sensor Tooling	3-11
3.9	Display Units	3-12
3.10	Crystal Life	3-12
3.11	Zero Thickness	3-13
3.12	Shutter Operation	3-13
3.13	Dual Sensors	3-13
3.14	Rate Sampling	3-14
3.15	Time Setpoint	3-15
3.16	Thickness Setpoint	3-16
3.17	Simulate Mode	3-17
3.18	Defaulting the Memory	3-17
3.19	Relay Operation	3-18
3.20	Analog Output Configuration	3-18
3.21	Depositing a Film	3-19

Chapter 4

SQM-160 Comm Software

4.1	Introduction	4-1
4.2	Installation	4-1
4.2.1	Update of an Older Version of SQM-160 Comm	4-2
4.3	Start the SQM-160 V2 Comm software.	4-3
4.4	Main Window	4-4
4.4.1	Menu Bar Functions	4-5
4.4.1.1	File Menu	4-6
4.4.1.2	Edit Menu	4-7
4.4.1.3	View Menu	4-7
4.4.1.4	Help Menu	4-7
4.4.2	Main Window Control Functions.	4-8
4.5	Data Log Window	4-9
4.5.1	Log File Pane	4-10
4.5.2	Duration Pane.	4-11
4.5.3	Time Range Pane.	4-11
4.5.4	Sampling Interval Pane	4-11
4.6	Films Window	4-11
4.7	System Parameters Window	4-15
4.8	Communications Setup Window.	4-17
4.8.1	Establishing Communications	4-18
4.8.2	Command Field	4-20
4.9	Configure Graph(s) Window	4-21
4.10	Help Menu	4-23

Chapter 5

Communications

5.1	Introduction	5-1
5.1.1	RS-232 Serial Port	5-1
5.1.2	USB Port.	5-2
5.1.3	Ethernet Port	5-2
5.1.3.1	How to Set Up the Network Protocol on the Computer	5-2
5.1.3.1.1	Accessing Network Settings in Windows XP	5-3
5.1.3.1.2	Accessing Network Settings in Windows 7 and Windows 8.	5-6
5.1.3.2	How to change the SQM-160 IP address.	5-8
5.2	SQM-160 Comm Software	5-9
5.3	SQM-160 Communications Protocol	5-9
5.3.1	Command Packet (Host to SQM-160 Message)	5-9
5.3.2	Response Packet (SQM-160 to Host Message).	5-10

5.3.3	Calculating the CRC	5-11
5.4	Commands	5-12
5.4.1	Command: @	5-13
5.4.2	Command: A	5-13
5.4.3	Command: B	5-15
5.4.4	Command: C	5-16
5.4.5	Command: D	5-17
5.4.6	Command: J	5-17
5.4.7	Command: L	5-17
5.4.8	Command: M	5-18
5.4.9	Command: N	5-18
5.4.10	Command: O	5-18
5.4.11	Command: P	5-19
5.4.12	Command: R	5-19
5.4.13	Command: S	5-19
5.4.14	Command: T	5-20
5.4.15	Command: U	5-20
5.4.16	Command: W	5-20
5.4.17	Command: Y	5-21
5.4.18	Command: Z	5-21
5.5	CRC Examples	5-22
5.5.1	Visual Basic® 5/6	5-22
5.5.2	Java®	5-24
5.5.3	C++	5-25

Chapter 6

Troubleshooting and Maintenance

6.1	Troubleshooting Guide	6-1
6.2	Maintenance	6-12
6.3	Spare Parts	6-12
6.4	Persistent Crystal Fail Indication	6-13

Chapter 7

Calibration Procedures

7.1	Importance of Density, Tooling and Z-Ratio	7-1
7.2	Determining Density	7-1
7.3	Determining Tooling	7-2
7.4	Laboratory Determination of Z-Ratio	7-3

Chapter 8

Measurement and Theory

8.1	Basics	8-1
8.1.1	Monitor Crystals	8-2
8.1.2	Period Measurement Technique	8-4
8.1.3	Z-match Technique	8-6

Appendix A

Material Table

A.1	Introduction	A-1
-----	------------------------	-----

This page is intentionally blank.

Chapter 1

Introduction and Specifications

1.1 Introduction

Figure 1-1 SQM-160 multi-film rate/thickness monitor



SQM-160™ uses proven INFICON® quartz crystal sensor technology to measure rate and thickness in a thin film deposition process. Two sensor inputs are standard and four additional sensor inputs are optional. Two recorder outputs provide both analog rate and thickness signals.

Sensor inputs are assigned to different materials, averaged for accurate deposition control in large systems or configured for a dual sensor. The rate sampling mode allows a shuttered sensor to extend sensor life in high rate processes. Rate displays of 0.1 Å/s or 0.01 Å/s are user-selectable. In addition, frequency or mass displays can be selected. Four relay outputs allow SQM-160 to control source or sensor shutters, signal time and thickness setpoints, and signal crystal failure. Digital inputs allow external signals to start/stop and zero readings.

SQM-160 comes with an RS-232 port and Windows® software that allows instrument setup from a computer. The software can be used to set and store all parameters, operate SQM-160, and save process data in a .txt file that can be imported into Excel®. Universal Serial Bus (USB) or Ethernet options add to the communications flexibility.

1.1.1 Related Manuals

Quartz crystal sensors are covered in separate manuals. The following manuals are available on the Thin Film Instrument and Sensor Manuals CD (PN 074-5000-G1), part of the ship kit:

- ◆ PN 074-154 - UHV Bakeable Sensor
- ◆ PN 074-156 - Front Load Single and Dual Sensors
- ◆ PN 074-157 - Sputtering Sensor
- ◆ PN 074-643 - ALD Sensor
- ◆ PN 147-800 - Cool Drawer Single and Dual Sensors

1.2 Instrument Safety

1.2.1 Definition of Notes, Cautions, and Warnings

When using this manual, please pay attention to notes, cautions, and warnings found throughout. For the purposes of this manual they are defined as follows:

NOTE: Pertinent information that when followed is useful in achieving maximum SQM-160 efficiency.



CAUTION

Failure to heed these messages could result in damage to SQM-160.



WARNING

Failure to heed these messages could result in personal injury.



WARNING - Risk Of Electric Shock

Dangerous voltages which could result in personal injury are present.

1.2.2 General Safety Information



WARNING

Do not open the SQM-160 case. Refer all maintenance to qualified personnel.

There are no user-serviceable components within the SQM-160 case. Dangerous voltages may be present whenever the power cable or external input/relay connectors are present.



WARNING

SQM-160 contains delicate circuitry, susceptible to transient power line voltages. Disconnect the power cable whenever making any interface connections.

Refer all maintenance to qualified personnel.

1.2.3 Earth Ground

SQM-160 is connected to earth ground through a sealed three-core (three-conductor) power cable, which must be plugged into a socket outlet with a protective earth terminal. Extension cables must always have three conductors including a protective earth terminal.



WARNING

Never interrupt the protective earth circuit.

This symbol indicates where the protective earth ground is connected inside SQM-160.

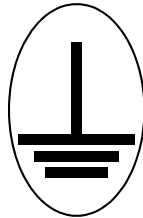

Never unscrew or loosen this connection.

Disconnecting the protective earth terminal or interrupting the protective earth circuit, whether inside or outside of SQM-160, may render SQM-160 dangerous.

1.3 How To Contact INFICON

Worldwide customer support information is available under **Support >> Support Worldwide** at www.inficon.com.

- ◆ Sales and Customer Service
- ◆ Technical Support
- ◆ Repair Service

When experiencing a problem with SQM-160, please have the following information readily available:

- ◆ The Sales Order or Purchase Order number of the SQM-160 purchase
- ◆ The version of SQM-160 firmware
- ◆ The version of Windows operating system
- ◆ A description of the problem
- ◆ An explanation of any corrective action that may have already been attempted
- ◆ The exact wording of any error messages that may have been received

1.3.1 Returning SQM-160

Do not return any component of SQM-160 to INFICON before speaking with a Customer Support Representative and obtaining a Return Material Authorization (RMA) number. SQM-160 will not be serviced without an RMA number.

Packages delivered to INFICON without an RMA number will be held until the customer is contacted. This will result in delays in servicing SQM-160.

If returning SQM-160 with a crystal sensor or another component potentially exposed to process materials, prior to being given an RMA number, a completed Declaration Of Contamination (DOC) form will be required. DOC forms must be approved by INFICON before an RMA number is issued. INFICON may require that the component be sent to a designated decontamination facility, not to the factory.

1.4 Specifications

1.4.1 Measurement

Sensor Inputs	Two standard, Four additional (optional)
Measurement Frequency Range . . .	6.5 to 1.0 MHz (adjustable)
Reference Frequency Accuracy	0.002%
Reference Frequency Stability	±2 ppm (total, 0 to 50°C)
Thickness Display Resolution	1 Å
Frequency Resolution ¹	Standard: ±0.30 Hz @ 6 MHz High Resolution option: ±0.03 Hz @ 6 MHz
Thickness and Rate Resolution/Measurement ²	Standard: ±0.37 Å High Resolution option: ±0.037 Å
Measurement Interval.	0.10 to 2.0 s (adjustable)

¹Resolution given for 0.10 s measurement interval

²Tooling/Density = 100/1, fundamental frequency = 6 MHz, 0.10 s measurement interval

PN 074-511-P1E

1.4.2 Film Parameters

Stored Films	99
Density	0.50 to 99.99 g/cm ³
Tooling	10 to 399%
Z-Ratio	0.10 to 10.00
Final Thickness	0.000 to 9999 kÅ
Thickness Setpoint	0.000 to 9999 kÅ
Time Setpoint	0:00 to 99:59 mm:ss
Sample/Hold	0 to 5999 s
Sensor Average	1 to 6, depending on sensors installed

1.4.3 System Parameters

Measurement Period	0.10 to 2.00 s
Simulate Mode	On/Off
Display Mode	Thickness in kÅ (THCK) Thickness in µm (NANM) Frequency in Hz (FREQ) Mass in µg/cm ² (MASS)
Rate Resolution	0.01 Å/s (HI) 0.1 Å/s (LO)
Measurement Filter	1 to 20 readings
Relay 2 Mode	Time Setpoint (TIME) Dual Sensor Shutter (DUAL) Sensor 2 Shutter (SNS2)
Relay (1 to 4)	Normally Open (nO)/Normally Closed (nC)
Rate Sampling	On/Off
RS-232 Baud Rate	2.4, 4.8, 9.6, 19.2, 38.4, 57.6, 115.2 kbps
Etch Mode	On/Off
Crystal Tooling (1 to 6)	10 to 399%
Frequency Min/Max	1.0 to 6.4 MHz/1.1 to 6.5 MHz
Analog Output Bounds	
Rate Min/Max	-99 to 999 Å/s
Thickness Min/Max	0.0 to -9999 kÅ

PN 074-511-P1E

1.4.4 Digital I/O

Digital Inputs	4
Functions	Open Shutter, Close Shutter, Zero Thickness, Zero Time
Input Rating	5 V (dc), non-isolated
Relay Outputs	4
Functions	Shutter, Sample/Hold or Thickness Setpoint, Dual Sensor Shutter or Time Setpoint, Crystal Fail
Relay Rating	30 V (rms) or 30 V (dc), 2 A maximum

1.4.5 General Specifications

Mains Power Supply	100 to 240 V (ac), ±10% nominal, 50/60 Hz
Fuse	5 x 20 mm, 500 mA, 250 V time lag
Power Consumption	20 W
Temporary Overvoltages	Short Term: 1440 V, <5 s Long Term: 490 V, >5 s
Operating Environment	0 to 50°C (32 to 122°F) 0 to 80% RH non-condensing 0 to 2000 m Indoor Use Only Class 1 Equipment (Grounded Type) Suitable for Continuous Operation Ordinary Protection (not protected against harmful ingress of moisture) Pollution Degree 2 Installation (Overvoltage) Category II for transient overvoltages
Storage Environment	-10 to 60°C (14 to 140°F)
Rack Dimensions (HxWxD)	8.85 x 21.26 x 19.68 cm (3.48 x 8.37 x 7.75 in.)
Weight	2.7 kg (6 lb.)

PN 074-511-P1E

1.5 Unpacking and Inspection

- 1 Remove SQM-160 from its packaging.
- 2 Carefully examine SQM-160 for damage that may have occurred during shipping. It is especially important to note obvious rough handling on the exterior of the container. *Immediately report any damage to the carrier as well as to INFICON.*
- 3 Turn **ON** SQM-160.
- 4 Refer to the invoice and take inventory (see [section 1.6](#)). Do not discard the packing materials before verifying inventory and power.
- 5 To install and set up, see [Chapter 2, Installation](#).
- 6 For additional information or technical assistance, contact INFICON (refer to [section 1.3 on page 1-4](#)).

1.6 Configurations and Accessories

1.6.1 SQM-160 Configurations

SQM-160SQM160-X-X-X

Consult the figure below for possible configurations.

Figure 1-2 SQM-160 configurations

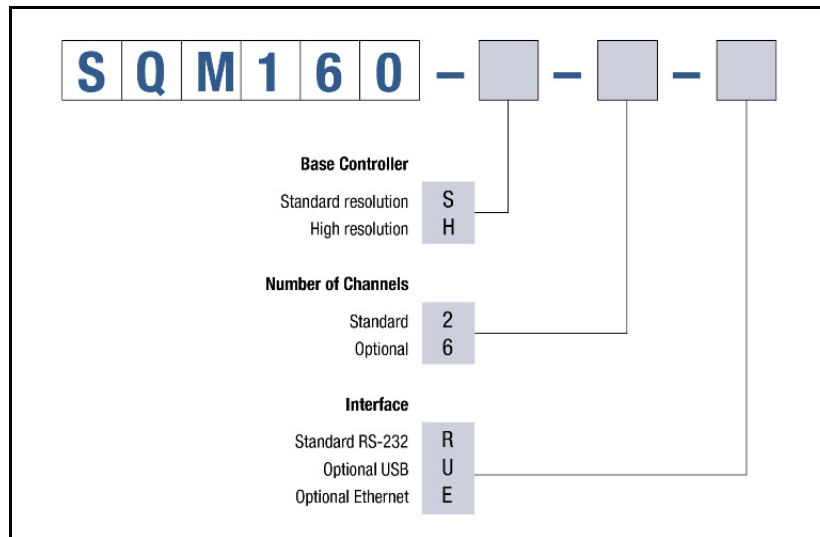

NOTE: All configurations ship with Thin Film Instrument and Sensor Manuals CD (PN 074-5000-G1), which contains the SQM-160 Operating Manual (PN 074-511), SQM-160 Comm software, and sensor manuals.

1.6.2 Accessories

1.6.2.1 Oscillator Kits

Each sensor requires an oscillator kit to interface with the controller:

3 m (10 ft.) Oscillator Kit	PN 783-500-109-10
7.6 m (25 ft.) Oscillator Kit	PN 783-500-109-25
15.2 m (50 ft.) Oscillator Kit	PN 783-500-109-50
22.8 m (75 ft.) Oscillator Kit	PN 783-500-109-75

Each oscillator kit includes:

- ◆ Oscillator, PN 783-500-013
- ◆ 15.2 cm (6 in.) BNC cable, PN 782-902-011
- ◆ One of the following BNC cables:

3 m (10 ft.) BNC Cable	PN 782-902-012-10
7.6 m (25 ft.) BNC Cable	PN 782-902-012-25
15.2 m (50 ft.) BNC Cable	PN 782-902-012-50
22.8 m (75 ft.) BNC Cable	PN 782-902-012-75

NOTE: These oscillator kits are designed for use with the standard in-vacuum cables which range in length from 15.2 cm (6 in.) to 78.1 cm (30.75 in.).

1.6.2.2 Rack Mounting Options

Rack mount kits allow one or two SQM-160 instruments to be installed in a standard 48.3 cm (19 in.) rack.

Full Rack Extender (one SQM-160)	PN 782-900-008
Rack Adapter (two SQM-160s)	PN 782-900-014

See [section 2.2, Rack Mounting Procedure, on page 2-3](#), for installation instructions.

1.6.2.3 Sensors

Front Load Single Sensor	SL-XXXXX
Front Load Dual Sensor	DL-AXXX
Cool Drawer Single Sensor	CDS-XXFXX
Cool Drawer Dual Sensor	CDD-XFXX
Sputtering Sensor	750-618-G1
UHV Bakeable Sensor	BK-AXF
ALD Sensor	750-713-G4
	750-717-G2
	750-717-G4

NOTE: X indicates user-selectable option (see www.inficon.com for Sensor Datasheets).

NOTE: All shuttered sensors require a feedthrough with an air line and a solenoid valve (PN 750-420-G1).

NOTE: Multi-crystal (rotary) sensor should not be used with SQM-160.

Chapter 2 Installation

2.1 Installation Requirements

2.1.1 Parts Requirements

- ◆ SQM-160 Monitor
- ◆ One or more crystal sensor/feedthrough(s)
- ◆ One oscillator kit for each crystal sensor
- ◆ Quartz crystals appropriate for the application



CAUTION

To maintain proper SQM-160 performance, use only the 15.2 cm (6 in.) BNC cable, included in the oscillator kit, to connect the oscillator to the crystal sensor.

The in-vacuum cable (Front Load and Sputtering Sensors) or electrical conduit tube (Cool Drawer, ALD, and UHV Bakeable Sensors) should not exceed 78.1 cm (30.75 in.).

2.1.2 Ground Requirements

Use low impedance cables or straps to connect the chassis of all control components to a common ground point on the vacuum chamber. The common ground point must be connected to the earth ground (see section 2.1.3 for the earth ground requirement).

Solid copper straps are recommended where RF is present. Use a strap of the shortest possible length, minimum width of 12.7 mm (0.5 in.), and approximately 0.56 mm (0.022 in.) thick. This is particularly important in high-noise e-beam systems (see Figure 2-1 for the recommended grounding method).

- ◆ The oscillator is grounded to SQM-160 and crystal sensor through the BNC cables.
- ◆ The crystal sensor is typically grounded to the wall of the vacuum system. If the sensor feedthrough is not properly grounded to earth through the vacuum system, connect a copper strap between the feedthrough and the common ground point on the vacuum system.

Figure 2-1 System grounding diagram

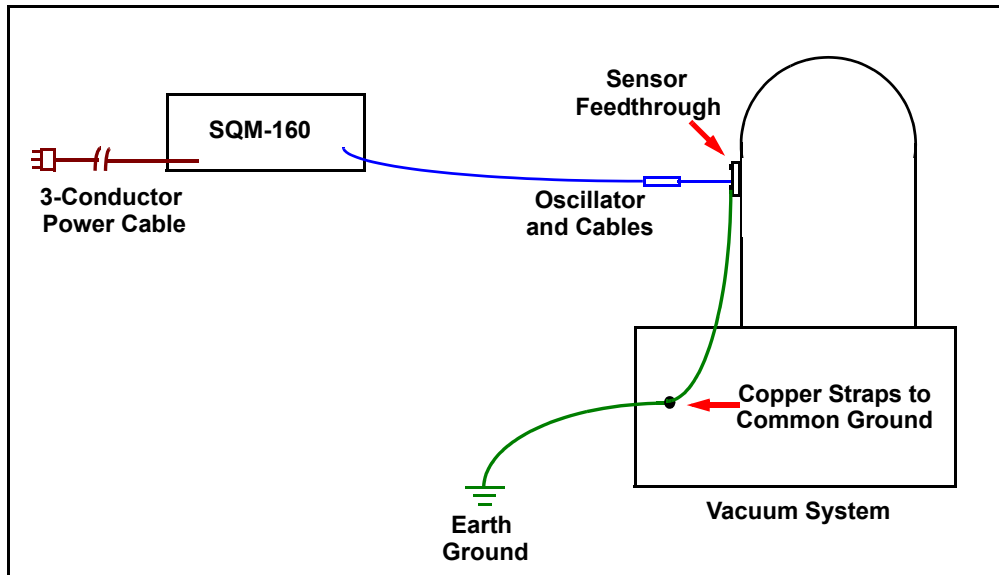

2.1.3 Establishing Earth Ground



WARNING - Risk Of Electric Shock

Follow local electrical regulations and codes.

- 1 Install two 3 m (10 ft.) long copper-clad steel ground rods into the soil, spaced at least 1.9 m (6.2 ft.) apart. The ideal distance between the rods is 6 m (20 ft.) (twice the rod length).
- 2 Pour a solution of magnesium sulfate or copper sulfate around each rod to reduce resistance to earth ground.
- 3 Test the ground rods using a ground resistance tester specifically designed for that purpose.
NOTE: Do not use a common ohmmeter.
- 4 After verifying that a good earth ground has been achieved, connect the rods together using solid copper straps at least 76 mm (3 in.) wide and approximately 0.9 to 1.3 mm (0.05 in.) thick, keeping the strap as short as possible.
NOTE: Do not use braided wire. Use a solid copper strap.

2.2 Rack Mounting Procedure

SQM-160 is designed to mount in a standard 48.3 cm (19 in.) rack using optional rack mount kits or can be used on a benchtop.

Two rack mount kits are available:

- ♦ Full Rack Extender (PN 782-900-008)
- ♦ Rack Adapter (PN 782-900-014)

2.2.1 Full Rack Extender

The optional Full Rack Extender (PN 782-900-008) mounts a single SQM-160 into a full-width 48.3 cm (19 in.) rack space.

2.2.1.1 Inventory

- ♦ Two rack mount ears
- ♦ Two large black aluminum panels
- ♦ Two small black aluminum panels
- ♦ Two hex shoulder screws
- ♦ Eight small flat-head screws
- ♦ Four large flat-head screws

2.2.1.2 Installation

1 Assemble the Extender

Use the eight small flat-head screws to connect the two small black aluminum panels and two large black aluminum panels (see [Figure 2-2](#)).

Figure 2-2 Assembly of extender

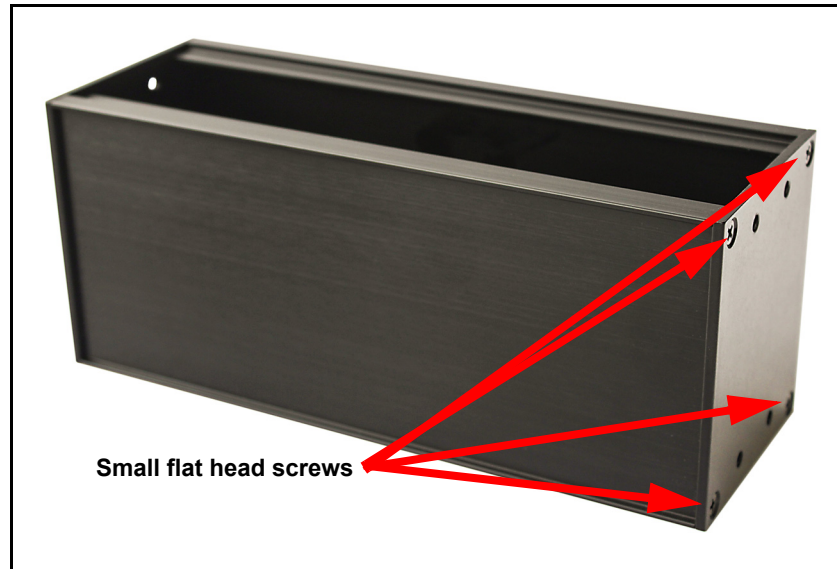

2 Install Hex Shoulder Screws

From inside the extender, thread two hex shoulder screws on one side, closest to the front of SQM-160. Continue to thread the screws until the threads are completely exposed (see [Figure 2-3](#) and [Figure 2-4](#)).

Figure 2-3 Installing hex shoulder screws - inside view



Figure 2-4 Installing hex shoulder screws - overall view



3 Attach the Extender

Align the extender with SQM-160 to fit the rack. The hex shoulder screws installed in step 2 need to align with the two large threaded holes in SQM-160. Tighten the hex shoulder screws to secure the extender to SQM-160 (see [Figure 2-5](#)).

Figure 2-5 Attach extender to SQM-160



4 Install the Rack Mount Ears

Using the four large flat-head screws provided, install the rack mount ears onto the outer ends of the instrument assembly. Install one rack mount ear to SQM-160, and the other to the extender (see [Figure 2-6](#) and [Figure 2-7](#)).

Figure 2-6 Installing rack mount ears

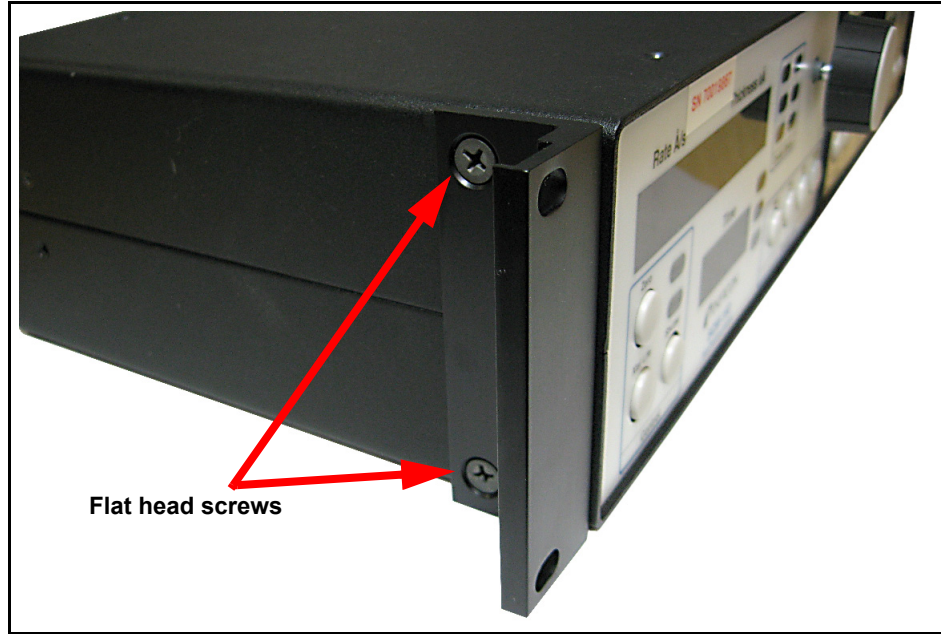

Figure 2-7 Full Rack Extender final assembly



5 Mount SQM-160

Slide the completed assembly (refer to [Figure 2-7](#)) into an empty 2U rack-mount space (8.9 cm [3.5 in.] H x 48.3 cm [19 in.] W). Secure the assembly with four rack screws (not provided).

2.2.2 Rack Adapter

The optional Rack Adapter (PN 782-900-014) mounts two SQM-160 or CI-100 instruments side-by-side in a full-width 48.3 cm (19 in.) rack space.

2.2.2.1 Inventory

- ◆ Two rack mount ears
- ◆ Two rear mount couplers
- ◆ Four 4-40 pan-head screws with washers
- ◆ Four flat-head screws

2.2.2.2 Installation

- 1 Locate and Remove the Appropriate Rear Panel Screws. Align the two instruments side-by-side, as though installed in the rack. Remove the two adjacent sets of screws on the rear panel (see [Figure 2-8](#)).

NOTE: These screws are no longer needed and may be discarded, or kept for other uses.

Figure 2-8 Locating the SQM-160 rear panel screws

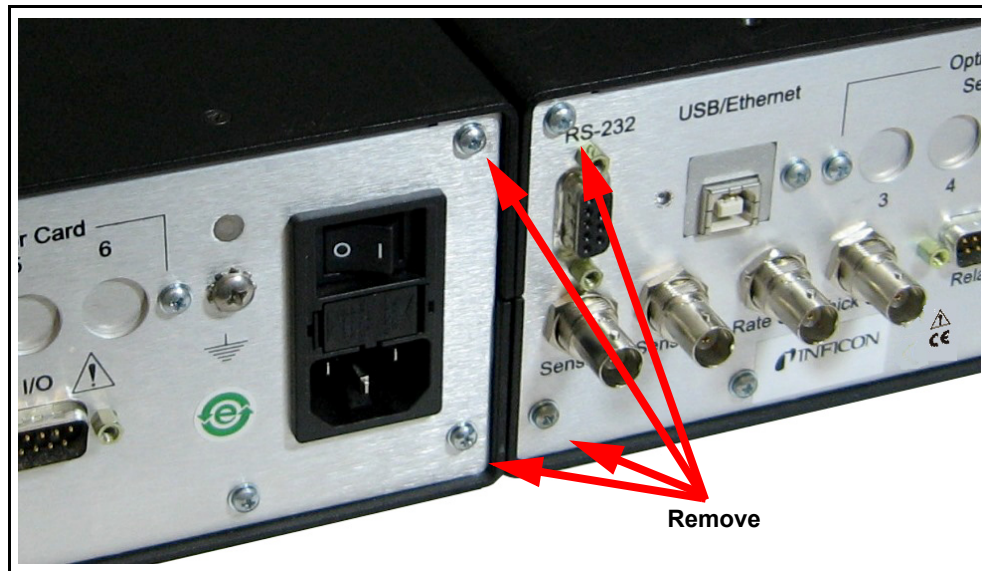

2 Install the Rear Mount Couplers

Using the four pan-head screws and washers provided, install one side of each rear mount coupler to each instrument (see [Figure 2-9](#)). Do not fully tighten the screws until all screws are installed.

Figure 2-9 Rear mount coupler installation

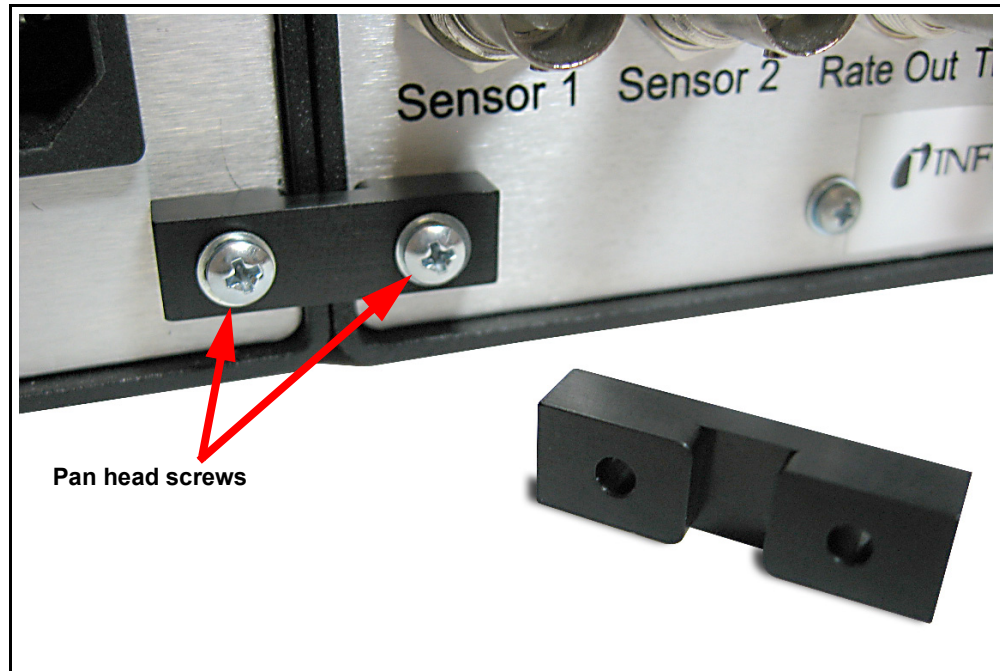

3 Install the Rack Mount Ears

Using the four flat-head screws provided, install the rack mount ears on the outer ends of the instrument assembly (see [Figure 2-10](#)). One rack mount ear should be installed on each instrument (see [Figure 2-11](#)).

Figure 2-10 Rack mount ear installation

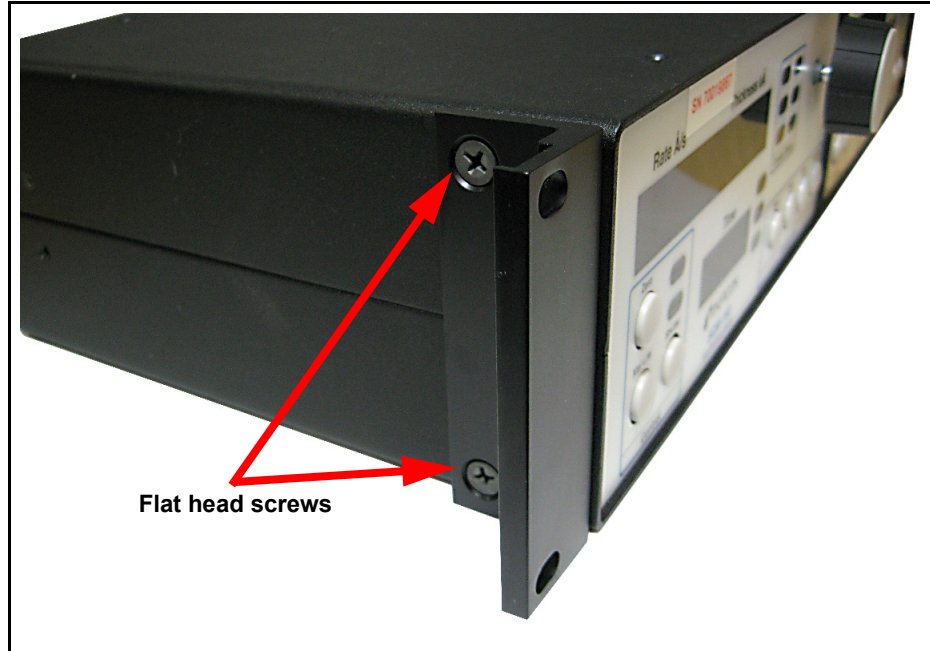
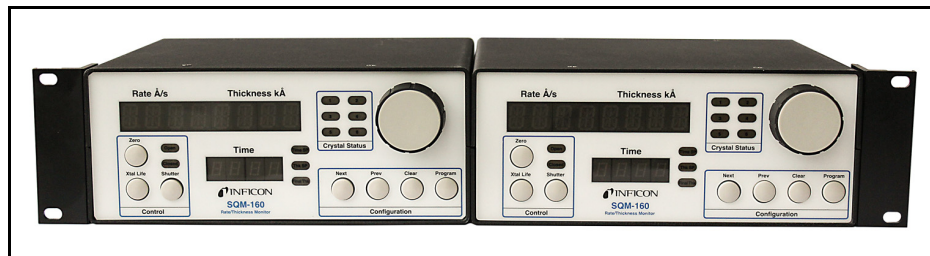

Figure 2-11 Rack Adapter final assembly



4 Mount the SQM-160 Assembly

Slide the completed assembly (refer to [Figure 2-11](#)) into an empty 2U rack mount space (8.9 cm [3.5 in.] H), 48.3 cm [19 in.] W). Secure the assembly with four rack screws (not provided).

2.3 Rear Panel Interfaces

Figure 2-12 Rear panel

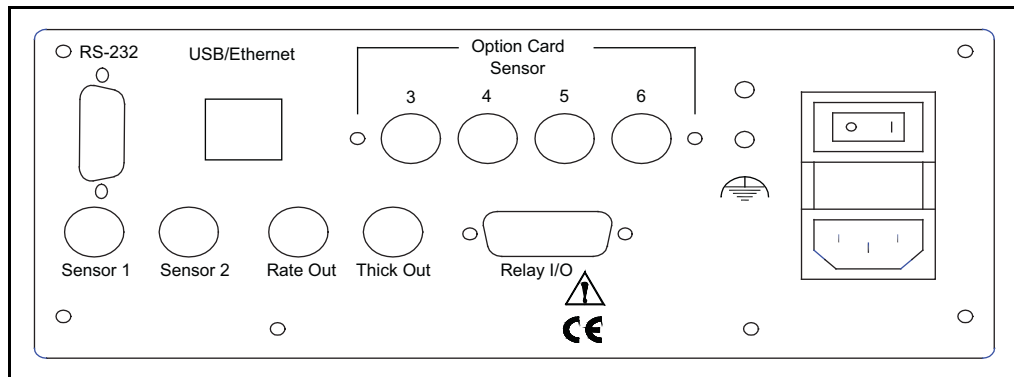

Sensor 1/Sensor 2

BNC connection to the oscillators for sensors 1 and 2 (see [section 2.4.1](#) for detailed information on sensor connections).

Rate Out/Thick Out

Provides 0 to 5 V (dc) analog outputs for rate and thickness readings. Rate and thickness output values are an average of all sensors in use for the active film (see [section 3.20, Analog Output Configuration](#), on page 3-18 for details on how to set the analog output scale).

Relay I/O

Connects 4 relays and 4 digital inputs to external devices (see [section 2.5 on page 2-14](#) relay I/O pinout and function information). Detailed programming information for relay functions can be found in [Chapter 3](#).

RS-232

Connection to computer for programming and data acquisition (see [Chapter 5, Communications](#)).

USB/Ethernet

Optional connection to computer USB or Ethernet port for programming and data acquisition (see [Chapter 5, Communications](#)).

Optional Sensor Card (3 to 6)

Provides four additional sensor measurement channels.



Measurement ground terminal useful for common system and cable grounding.

Power Connector and Fuse

Receptacle for mains power. SQM-160 contains a universal power supply capable of accepting 100 to 240 V (ac) input at 50/60 Hz.

Fuse is 5 x 20 mm, 500 mA, 250 V time lag (PN 062-0105).



WARNING - Risk Of Electric Shock

Use a removable power cable only of the specified type and rating, attached to a properly grounded receptacle.

ON/OFF Switch (I/O)

Turns the SQM-160 power ON(I) or OFF(O).

2.4 System Connections

See Figure 2-13 for a simple vacuum system diagram.



WARNING - Risk Of Electric Shock

Maintain adequate insulation and physical separation of sensor and I/O wiring from hazardous voltages.

Figure 2-13 Typical vacuum system wiring

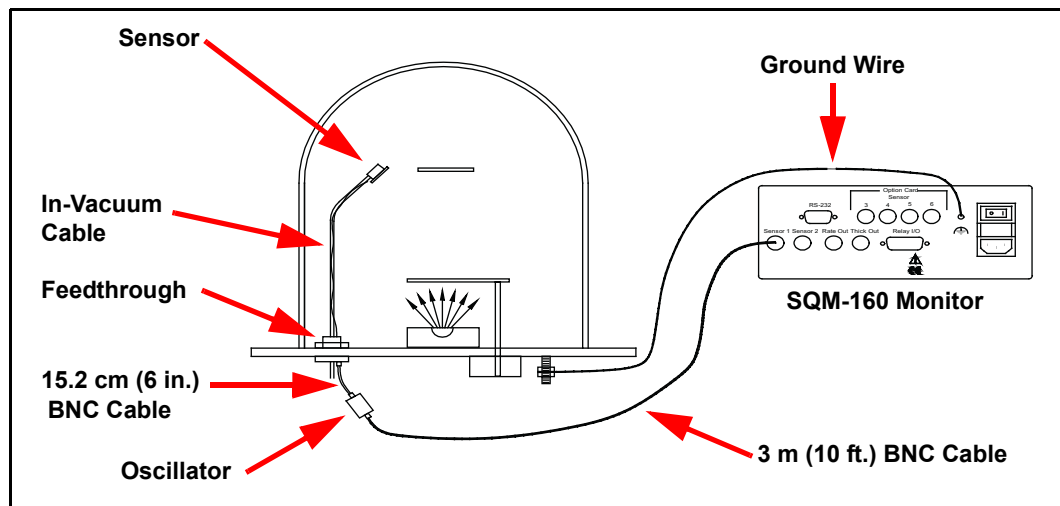

PN 074-511-P1E

Sensor

Holds the quartz crystal used to measure rate and thickness. Crystals must routinely be replaced. Refer to the appropriate sensor operating manual for installation and maintenance instructions particular to that sensor.

In-Vacuum Cable

Connects the sensor to the feedthrough.

Feedthrough

Provides isolation between vacuum and atmosphere for electrical connections, water, air, and/or purge gas tubes.

15.2 cm (6 in.) BNC Cable

Provides a flexible connection from the feedthrough to the oscillator.

Oscillator

Contains the electronics to operate the quartz crystal. The length from the oscillator to the crystal should be under 1 m (40 in.).

3 m (10 ft.) BNC Cable

Connects the oscillator to SQM-160. Lengths up to 22.8 m (75 ft.) are acceptable.

Ground Wire

A wire, preferably a solid copper ground strap, that connects the earth-grounded vacuum system to SQM-160 ground terminal (refer to [section 2.1.2, Ground Requirements, on page 2-2](#)).

2.4.1 Sensor Connections

- 1** Connect one end of the oscillator cable (PN 782-902-012-XX) to any SQM-160 sensor connectors.
- 2** Connect the other end of the oscillator cable to the BNC connector on the oscillator labeled **Control Unit**.
- 3** Connect one end of the 15.2 cm (6 in.) BNC cable (PN 782-902-011) to the BNC connector on the oscillator labeled **Sensor**.
- 4** Connect the other end of the 15.2 cm (6 in.) BNC cable to the BNC connector on the feedthrough.
- 5** Install a new 5 or 6 MHz crystal into the sensor.

NOTE: Refer to the sensor operating manual for crystal installation instructions.

**CAUTION**

To maintain proper SQM-160 performance, use only the 15.2 cm (6 in.) BNC cable, included in the oscillator kit, to connect the oscillator to crystal sensor.

The in-vacuum cable (Front Load and Sputtering Sensors) or electrical conduit tube (Cool Drawer, ALD, and UHV Bakeable Sensors) should not exceed 78.1 cm (30.75 in.).

**WARNING - Risk Of Electric Shock**

Maintain adequate insulation and physical separation of sensor, I/O, and wiring from hazardous voltages.

- 6 Turn **ON** SQM-160, using the **ON/OFF** switch.

2.5 I/O Connections

A 15-pin, female D-sub connector is included with SQM-160 to connect the digital I/O to SQM-160 Relay I/O connector. See [Figure 2-14](#) for the solder-side pin assignments for D-sub connector.

Figure 2-14 Relay I/O D-sub connector rear view

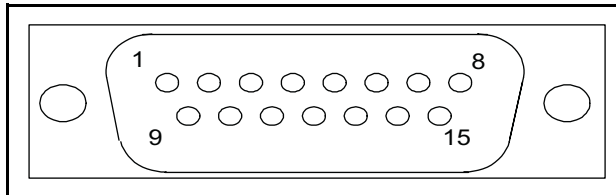

Table 2-1 Pin functions and descriptions

Pins	Function	Description
1,2 Relay 1	Crystal Fail Relay	Activates when all enabled sensors have failed.
3,4 Relay 2	Time Setpoint, Dual Sensor, or Sensor 2 Shutter Relay	If RL2 in the System menu is set to: <ul style="list-style-type: none"> ◆ TIME - Relay 2 activates when time counts down to zero from the programmed Time Setpoint value (see section 3.15 on page 3-15). ◆ DUAL - Relay 2 activates when Sensor 1 fails (see section 3.13 on page 3-13). ◆ SNS2 - Relay 2 activates when the Shutter button is pressed when Sensor 2 is programmed for the active film.
5,6 Relay 3	Shutter Relay	<ul style="list-style-type: none"> ◆ Controlled by the Shutter button on the front panel. Activated when the Shutter Open indicator is illuminated. ◆ If SNS2 is selected for RL2 in the System menu, the shutter relay activates only if Sensor 1 is programmed for the active film.
7,8 Relay 4	Sampling or Thickness Setpoint	<ul style="list-style-type: none"> ◆ If Sampling is ON in the System menu, Relay 4 activates during Sample and open during Hold (see section 3.14 on page 3-14). ◆ If Sampling is OFF, Relay 4 activates when Thickness Setpoint is reached.
9	Zero Time Input	Grounding this pin zeroes the setpoint time.
10	Zero Thick Input	Grounding this pin zeroes the thickness display.
11	Close Shutter Input	Grounding this pin opens the shutter relay.
12	Open Shutter Input	Grounding this pin closes the shutter relay.
13,14,15	Ground	



WARNING

The inputs are not isolated. The voltage level applied must be limited between 0 and +5 V (dc), with respect to ground.



WARNING

Output relays are rated for 30 V (rms) or 30 V (dc), at 2 A maximum. Provide proper fusing and adequate wiring insulation and separation in case the limits are exceeded.

This page is intentionally blank.

Chapter 3 Operation

3.1 Introduction

This chapter details the operation of the SQM-160 menus and front panel controls.

3.2 Front Panel Controls

Figure 3-1 SQM-160 front panel

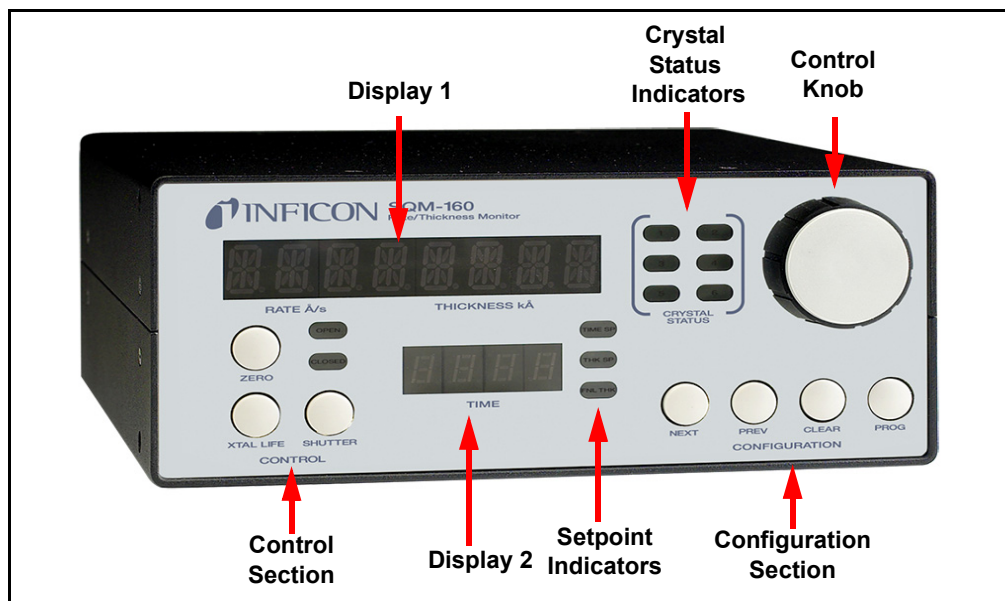

Display 1

- ◆ Displays Rate/Thickness or Frequency in normal operation.
- ◆ If multiple sensors are being used and Time is displayed on Display 2, the average of the sensors is displayed. Rotate the **Control Knob** to display each individual sensor readings.
- ◆ Displays the setup parameter name in Program mode.

Display 2

- ◆ Displays deposition Time during normal operation.
- ◆ When using the Control Knob to display individual sensor readings on Display 1, the sensor number corresponding to reading in Display 1 is displayed on Display 2.
- ◆ Displays setup parameter values in Program mode.

Control Section

- Zero** Press to zero the thickness reading.
- Xtal Life** Press to toggle display between Crystal Life and Rate/Thickness readings.
- Shutter**. Press to activate/deactivate shutter relay.
- Open/Closed indicator** Displays the status of the shutter relay.

Configuration Section

- Program** Press to enter/exit Program mode.
- Clear** Press to cancel a change and return the displayed parameter to original value.
- Prev** Press to move to previous parameter. Saves the current setting. If pressed immediately after entering Program mode, allows access to System parameters.
- Next** Press to move to next parameter. Saves the current setting.

Setpoint Indicators

- ◆ Illuminates when the indicated setpoint is reached.

Crystal Status Indicators

- ◆ Illuminates when the crystal is active and operating properly.
- ◆ Flashes when an active crystal fails.
- ◆ Extinguishes when the crystal is not being used.

Control Knob

- ◆ Used to adjust values or scroll through menu selections.
- ◆ Press the **Control Knob** to save the current setting and display the next setting.
- ◆ Press the **Control Knob** to enable or disable a sensor channel when editing Sensor Average.

3.3 Menu Selection

Two menus provide control for programming SQM-160.

- ◆ The Film menu customizes each stored film.
- ◆ The System menu sets values that apply to all films.

The Configuration section of SQM-160 front panel contains four buttons used to access the Program menus. Within the Program menus, the Control Knob also adjusts values and selects menu options. In Program mode, Display 1 indicates the parameter to be changed. Display 2 indicates the value of the selected parameter.

NOTE: If Crystal Life is displayed on SQM-160 display, press **Xtal Life** to return to normal Rate/Thickness or Frequency display.

To enter the Film menu, press **Program**. SQM-160 displays the currently selected film. First rotate and then press the **Control Knob** or **Next** to select a different film and display the first parameter for the selected film.

To enter the System menu, press **Program** then press **Prev**.

Figure 3-2 SQM-160 front panel

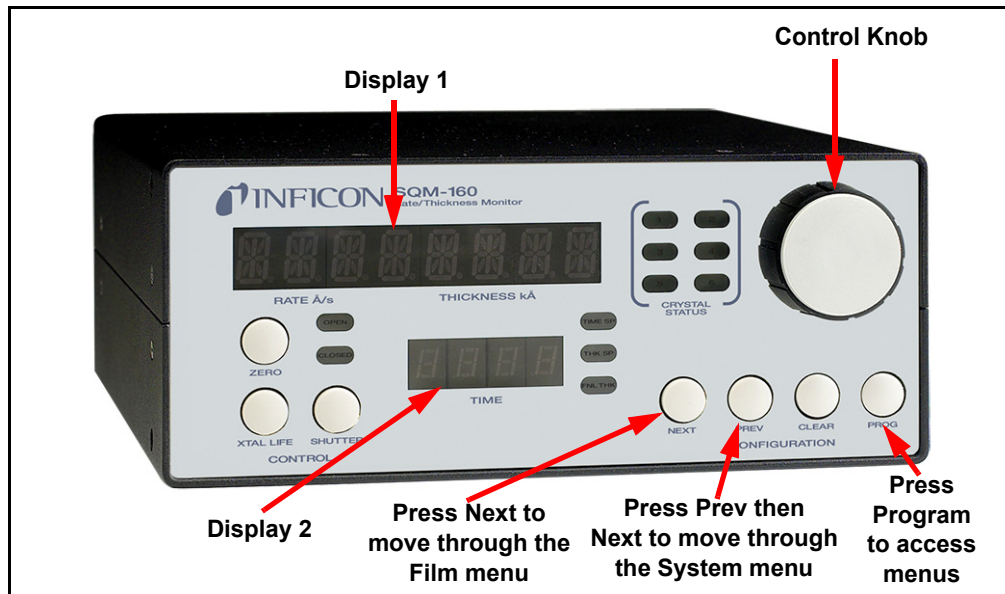

PN 074-511-P1E

3.4 Film Menu

The Film menu aids in programming SQM-160 for the materials that will be deposited. Ninety-nine films can be stored, but only one film is active at any time.

- 1 Press **Program** to enter Program mode.
- 2 Rotate the **Control Knob** to select the desired Film (1 to 99).
- 3 Press the **Control Knob** or **Next** to display the parameters for the selected film.

NOTE: This will set the active film and should not be done while running. Press **Program** to abort with no change.

- 4 Press **Next** or **Prev** to select other parameters in the Film menu. The selected parameter is seen on Display 1 (refer to [Figure 3-2](#)).
- 5 Rotate the **Control Knob** to edit the parameter value displayed on Display 2 (refer to [Figure 3-2](#)).
- 6 Press the **Control Knob**, **Next**, or **Prev** to save the displayed value and move to the next material parameter. Press **Clear** to abandon the change and return to the original value.
- 7 Press **Program** to exit the Film menu and return to Normal mode.

NOTE: [Figure 3-3](#) and [Table 3-1](#) detail the parameters available in the Film menu. Instructions for setting specific parameters are detailed in later sections of this chapter.

Figure 3-3 Film menu

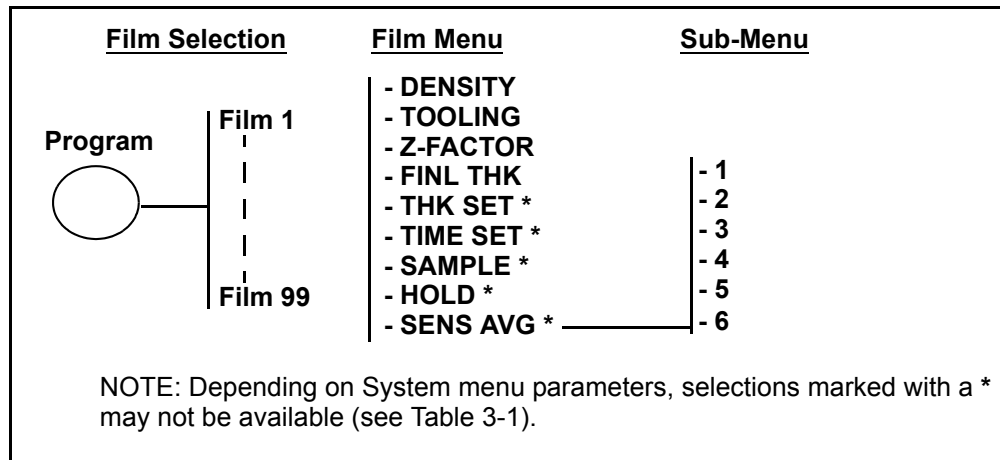

Table 3-1 Film menu

Display	Description	Range	Default	Units
DENSITY	Density of the material being deposited (see Appendix A for common material densities).	0.50 to 99.99	1.00	g/cm ³
TOOLING	Overall Tooling Factor for this film (see section 3.8 on page 3-11).	10 to 399	100	%
Z-FACTOR	Z-Ratio of the material being deposited (see Appendix A for common material Z-Ratios).	0.10 to 9.999	1.0	
FINL THK	Programmed Final Thickness of deposited material. Illuminates Final Thk indicator when reached.	0.000 to 9999	0.500	kÅ
THK SET	Thickness value that activates the Thickness Setpoint relay (Relay 4) and illuminates Thk SP indicator. Not available when Sampling is ON in System menu.	0.000 to 9999	0.000	kÅ
TIME SET	Elapsed time that activates the Time Setpoint relay (Relay 2) and illuminates Time SP indicator. Not available when Relay 2 (RL2) is set to DUAL or SNS2 in the System menu.	0:00 to 99:59	0:00	mm:ss
SAMPLE	The time for the sensor shutter to remain open when Sampling is enabled in the System menu (see section 3.14 on page 3-14). Not available when Sampling is disabled in System menu.	0 to 5999	0	s
HOLD	The time for the sensor shutter to remain closed when Sampling is enabled in the System menu (see section 3.14 on page 3-14). Not available when Sampling is disabled in System menu.	0 to 5999	0	s
SENS AVG	Enable/disable crystals for the selected film (see section 3.6 on page 3-9). Not available when Relay 2 (RL2) is set to DUAL in the System menu.	Enabled/ Disabled	Ch1 Enabled	

PN 074-511-P1E

3.5 System Menu

The System menu sets function values for SQM-160 and the vacuum system setup. System menu parameters apply to all films.

- 1 Press **Program** to enter Program mode.
- 2 Press **Prev** to display the System menu.
- 3 Press **Next** and **Prev** to select other parameters in the System menu.
- 4 Rotate the **Control Knob** to edit the parameter value displayed on Display 2 (refer to [Figure 3-2 on page 3-3](#)).
- 5 Press the **Control Knob**, **Next**, or **Prev** to save the displayed value and move to the next (or previous) material parameter. Press **Clear** or **Program** to abandon the change and return to the original value.
- 6 Press **Program** to exit the System menu and return to Normal mode.

Figure 3-4 System parameters menu

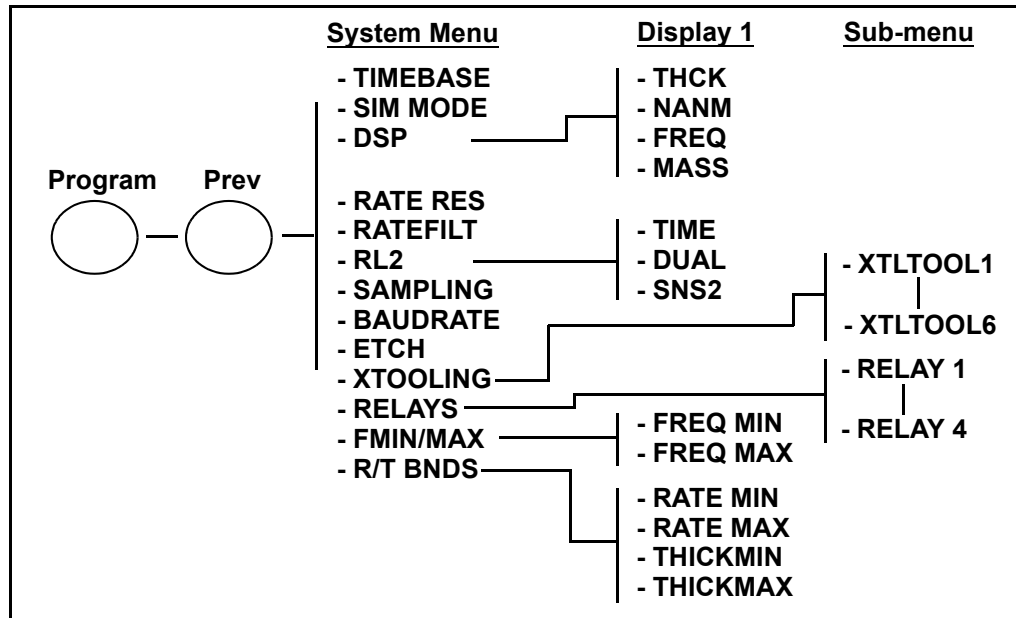

Table 3-2 System menu

Display	Description	Range	Default	Units
TIMEBASE	Time required for a measurement. Longer times yield higher accuracy.	0.10 to 2.00 Increments by 0.05 s	0.25	s
SIM MODE	Simulates sensor inputs and frequency/rate readings.	On/Off	Off	
DSP	Selects the value to display on Display 1: <ul style="list-style-type: none"> ◆ Rate/Thickness in Angstroms ◆ Rate/Thickness in Nanometers ◆ Frequency ◆ Mass See section 3.9 on page 3-12 for details.	THCK/NANM/ FREQ/MASS	THCK	
RATE RES	Sets rate resolution to 0.01 (high) or 0.1 Å/s (low).	HI/LO	LO	
RATEFILT	Number of rate readings averaged.	1 to 20	8	
RL2	Selects the function of Relay 2: <ul style="list-style-type: none"> ◆ TIME causes Relay 2 to activate when time setpoint is reached (see section 3.15 on page 3-15). ◆ DUAL causes Relay 2 to activate a dual sensor shutter when Sensor 1 fails (see section 3.13 on page 3-13). ◆ SNS2 causes Relay 2 to activate a sensor shutter when Sensor 2 is assigned to a film. 	TIME/DUAL/ SNS2	Time	
SAMPLING	When Sampling is ON, the sensor shutter periodically samples the rate, then closes the shutter. SQM-160 holds the same rate reading until the next sample period (see section 3.14 on page 3-14). Sample and Hold times are set in the Film menu (refer to section 3.4).	On/Off	Off	
BAUDRATE	Serial baud rate to computer.	2.40/4.80/9.60/ 19.20/38.40/ 57.60/115.2	19.20	kbps
ETCH	Sets rate negative for etching.	On/Off	Off	
XTOOLING	Tooling value assigned to each sensor. See section 3.8, Sensor Tooling, on page 3-11 .	10 to 399	100	%

PN 074-511-P1E

Table 3-2 System menu (continued)

Display	Description	Range	Default	Units
RELAYS	Assigns normally open or normally closed operation for each relay. NOTE: All relays are open with power OFF .	nO/nC	nO	
FMIN/MAX	Sub-menu sets minimum and maximum crystal frequencies (see section 3.7 on page 3-10).	Min: 1.00 to 6.40 Max: 1.10 to 6.50	5.00 6.10	MHz
R/T BNDS	Rate and Thickness Bounds sub-menu for analog outputs (see section 3.20 on page 3-18).	See below		
RATE MIN	Deposition rate for zero output (0 V). Must be set lower than RATE MAX.	-99 to 999	0	Å/s
RATE MAX	Deposition rate for full-scale output (+5 V(dc)). Must be set higher than RATE MIN.	-99 to 999	100	Å/s
THICKMIN	Thickness for zero output (0 V). Must be set lower than THICKMAX.	0.000 to 9999	0.000	kÅ
THICKMAX	Thickness for full scale output (+5 V (dc)). Must be set higher than THICKMIN.	0.000 to 9999	1.000	kÅ

3.6 Sensor Selection

SQM-160 comes standard with two sensor inputs. Four additional sensors are available by adding a Sensor Option Card. A specific sensor can be assigned to each film, or multiple sensors can be assigned to a film for sensor averaging. The averaging option provides more uniform coverage of the deposition area and provides backup sensor capability. If one of the sensors assigned to a film fails, that sensor is automatically removed from rate/thickness calculations.

NOTE: If Relay 2 (RL2) is set to DUAL in the System menu, Sensors 1 and 2 are set as a primary/secondary sensor pair and sensor averaging is disabled (see [section 3.13 on page 3-13](#) for information on dual sensors).

To assign a sensor, or sensors, to a film:

- 1** Press **Program** to enter Program mode.
- 2** Use the **Control Knob** to scroll to the desired film (1 to 99).
- 3** Press the **Control Knob** or **Next** to enter the Film menu for the selected film and set the selected film as the active film.
- 4** Press **Next** until SENS AVG is displayed.
- 5** Rotate the **Control Knob** to display each sensor in Display 2.
- 6** Press the **Control Knob** to toggle the indicated sensor On/Off.

The Crystal Status indicators indicate the sensor status for each sensor:

- ◆ If the indicator is extinguished, the sensor is disabled.
 - ◆ If the indicator is illuminated, the sensor is enabled and SQM-160 is receiving valid readings.
 - ◆ If the indicator is blinking, the sensor is enabled, but SQM-160 is not receiving valid readings (crystal fail) (see [Chapter 6, Troubleshooting and Maintenance](#)).
- 7** Continue selecting sensors until the Crystal Status indicators indicate the desired setup.
 - 8** Press **Program** to exit the Film menu and return to Normal mode.
 - 9** Rotate the **Control Knob** to display each enabled sensor reading on Display 1.
 - ◆ When an individual sensor number is displayed in Display 2, the number in Display 1 is the individual reading for that sensor.
 - ◆ When time is displayed in Display 2, the number in Display 1 is the average of all assigned sensors.

3.7 Sensor Frequency

Sensor Minimum and Maximum frequencies establish the operating range for the sensing quartz crystals. Both values are used to determine the % life that is displayed in Xtal Life mode.

When the sensor frequency reads below the minimum or above the maximum, SQM-160 indicates a sensor failure (crystal fail) with a flashing Crystal Status indicator.

To set sensor minimum and maximum frequencies:

- 1** Press **Program** to enter Program mode.
- 2** Press **Prev** to enter the System menu.
- 3** Press **Next** until FMIN/FMAX displays on Display 1.
- 4** Press the **Control Knob** to display FREQ MIN on Display 1.
- 5** Rotate the **Control Knob** to edit the minimum operating frequency on Display 2 (typically 5.0 MHz for a 6 MHz crystal).
- 6** Press the **Control Knob** to accept the minimum value and display FREQ MAX on Display 1.
- 7** Rotate the **Control Knob** to edit the maximum operating frequency on Display 2 (typically 6.0 or 6.1 MHz for a 6 MHz crystal).
- 8** Press the **Control Knob** to accept the maximum value.
- 9** Press **Program** to exit the System menu and return to Normal mode.

Crystals sometimes fail unexpectedly, or exhibit erratic frequency shifts (mode hopping) before total failure. Depending on the material, crystals may fail well before the typical 5 MHz minimum. If the crystals consistently fail early, set FREQ MIN to a value higher than 5 MHz to provide a Crystal Life warning that is consistent with actual failure.

A sensor crystal with an initial value that exceeds the maximum frequency will also cause a flashing Crystal Status indicator. The maximum frequency can be set slightly above the nominal values with no effect on accuracy.

3.8 Sensor Tooling

Sensor Tooling (xTooling) adjusts for the difference in deposition rate between the sensor and the substrate being coated. It is an empirically determined value that aligns the sensor readings to the vacuum system.

- ♦ 100% tooling indicates that the sensor and substrate receive the same amount of material during deposition.
- ♦ Tooling values over 100% indicate that the sensor receives less material than the substrate (see [Figure 3-5 \(a\)](#)).
- ♦ Tooling values under 100% indicate that the sensor receives more material than the substrate (see [Figure 3-5 \(b\)](#)).

Figure 3-5 Sensor Tooling

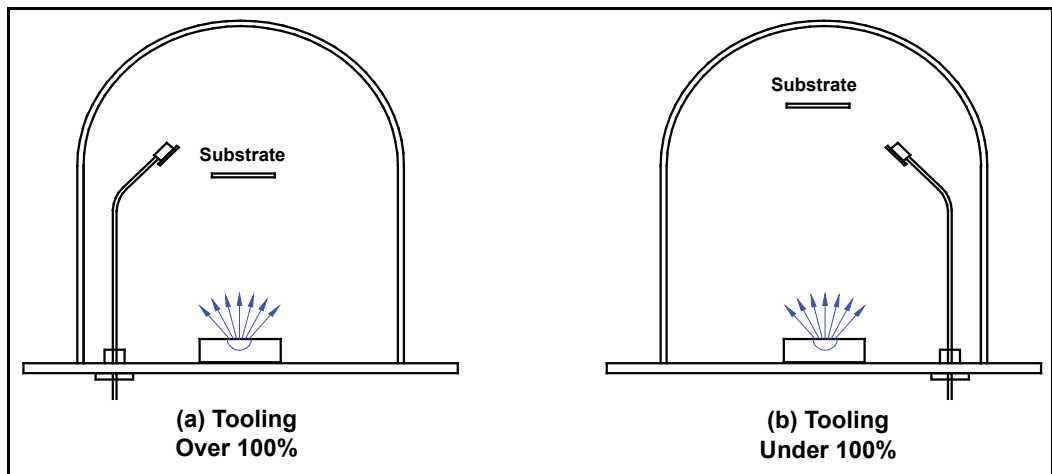

Sensor Tooling is set in the System menu. It adjusts the tooling for each individual sensor before it is averaged. Sensor Tooling for a sensor applies to all films.

If the Sensor Tooling parameters are set properly, a sensor failure will not cause a jump in the average Rate and Thickness reading (see [section 7.3 on page 7-2](#)).

To adjust Sensor Tooling:

- 1 Press **Program** to enter Program mode.
- 2 Press **Prev** to enter the System menu.
- 3 Press **Next** until xTOOLING is displayed on Display 1, then press the **Control Knob**. XTLTOOL 1 will be displayed, indicating Sensor Tooling for Sensor 1.
- 4 Rotate the **Control Knob** to edit the XTLTOOL 1 (Sensor 1 Tooling) value on Display 2. Press the **Control Knob** to save the value and display XTLTOOL 2 (Sensor 2 Tooling).
- 5 Repeat step 4 for each of the installed sensors.
- 6 Press **Program** to exit the System menu.

NOTE: Sensor Tooling is different from Film Tooling. Film Tooling is set in the Film menu and is applied to the averaged Rate and Thickness for all sensors assigned to that film. Film Tooling is a film-specific value.

3.9 Display Units

SQM-160 can display crystal measurements in several different units.

To select the display units:

- 1 Press **Program** to enter Program mode.
- 2 Press **Prev** to enter the System menu.
- 3 Press **Next** until DSP... is displayed on Display 1.
- 4 Rotate the **Control Knob** to select the desired display mode:
 - ♦ THCK — Rate in Å/s, Thickness in kÅ
 - ♦ NANM — Rate in nm/s, Thickness in µm
 - ♦ MASS — Rate in ng/cm²/s, Mass in µg/cm²
 - ♦ FREQ — Frequency in Hz

NOTE: When NANM is selected a lowercase n is displayed between the rate and thickness values. When MASS is selected a lowercase m is displayed between the rate and thickness values.

- 5 Press the **Control Knob**, **Next**, or **Prev** to accept the choice.
- 6 Press **Program** to exit the System menu and return to Normal mode.

NOTE: The Display Units setting does not affect data returned through remote communications or analog outputs.

3.10 Crystal Life

SQM-160 calculates the crystal life value based on the current frequency compared to the FMIN/FMAX values set in the System menu (refer to [section 3.5 on page 3-6](#) and [section 3.7 on page 3-10](#)). A new crystal should indicate between 95 and 100% crystal life.

To display the remaining crystal life for the sensors used by the currently active film:

- 1 Press **Xtal Life**.
- 2 The sensor is displayed on Display 1 and the % remaining life is displayed on Display 2.
- 3 Rotate the **Control Knob** to display the % life of other sensors active for the selected film.
- 4 Press **Xtal Life** again to return to normal rate/thickness or frequency display.

NOTE: Program mode is not available while the crystal life display is active.

NOTE: Usable crystal life depends on the material being evaporated and other process characteristics. Rate noise and other failure modes may be observed before the crystal life value reaches 0%.

3.11 Zero Thickness

Before starting each film deposition, reset the SQM-160 Thickness value to **zero**. To zero Thickness, press **Zero** on the front panel Control section.

In addition to zeroing Thickness, pressing **Zero** has the following effects:

- ♦ The Time display is reset to the programmed value and starts counting down.
- ♦ The Thickness and Time Setpoint relays deactivate.
- ♦ The Time SP, Thk SP, and Final Thk indicators extinguish.

3.12 Shutter Operation

The SQM-160 Shutter button controls a relay (Relay 3) that is normally connected to the source shutter. To activate or deactivate the Shutter relay, press **Shutter**.

The Open and Closed indicators illuminate to indicate the shutter status.

NOTE: If Relay 2 (RL2) is set to SNS2 in the System menu, the operation of the Shutter relay changes slightly. In this case, Relay 3 will activate only if Sensor 1 is assigned to the active film. If Sensor 2 is assigned to the active film, Relay 2 will activate instead.

3.13 Dual Sensors

Dual sensors provide a backup (secondary) crystal should the primary crystal fail. When Relay 2 (RL2) is programmed for DUAL in the System menu, SQM-160 will automatically switch to Sensor 2 when Sensor 1 readings stop or become erratic. Relay 2 will activate when Sensor 2 is in operation to actuate a dual sensor shutter.

To program SQM-160 for dual sensors:

- 1 Press **Program** to enter Program mode.
- 2 Press **Prev** to enter the System menu.
- 3 Press **Next** until RL2 is displayed on Display 1.
- 4 Rotate the **Control Knob** clockwise to select DUAL sensor function.
- 5 Press the **Control Knob** to accept the value.
- 6 Press **Program** to exit the System menu and return to Normal mode.
- 7 In the Film menu, assign only **Sensor 1** to the film. The backup Sensor 2 is automatically assigned internally.

NOTE: Relay 2 is a multi-function relay. Relay 2 can be programmed as a dual sensor shutter, it will activate when a programmed time has elapsed, or as a Sensor 2 shutter relay. The function of Relay 2 is set in the System menu RL2 parameter (refer to [section 3.5 on page 3-6](#) for more information about SQM-160 System parameters or see [section 3.19 on page 3-18](#) for more information about SQM-160 relay functions).

3.14 Rate Sampling

With Rate Sampling enabled, SQM-160 opens a sensor shutter for a fixed time in order to sample the rate. SQM-160 then closes the shutter and for a fixed time. While the shutter is closed (Hold mode), SQM-160 calculates thickness based on the last sampled rate.

NOTE: Rate sampling can significantly extend crystal life in high deposition rate and long processes. However, unless the process is very stable, the thickness calculation during Hold mode may be incorrect. Do not use rate sampling if the rates vary during deposition.

To program SQM-160 for Rate Sampling:

- 1 Press **Program** to enter Program mode.
- 2 Press **Prev** to enter the System menu.
- 3 Press **Next** until SAMPLING is displayed on Display 1.
- 4 Rotate the **Control Knob** clockwise to set SAMPLING to ON.
- 5 Press the **Control Knob** to accept the value.
- 6 Press **Program** to exit the System menu and return to Normal mode.
- 7 Press **Program** to return to Program mode.
- 8 Rotate the **Control Knob** to select the desired film (1 to 99), then press the **Control Knob** or **Next** to display the Film menu for the selected film.
- 9 Press **Next** until SAMPLE is displayed on Display 1.
- 10 Rotate the **Control Knob** to edit the SAMPLE value displayed on Display 2. Press the **Control Knob** to accept the SAMPLE value and display HOLD.
NOTE: SAMPLE is the amount of time the sensor shutter will remain open.
- 11 Rotate the **Control Knob** to edit the HOLD value displayed on Display 2. Press the **Control Knob** to accept the HOLD value.
NOTE: HOLD is the amount of time the sensor shutter will remain closed. The displayed Rate during this time is the last sampled rate.
- 12 Press **Program** to exit the Film menu and return to Normal mode.

NOTE: Relay 4 is a dual function relay. It can be programmed either for Rate Sampling or as a Thickness Setpoint relay (see [section 3.16, Thickness Setpoint, on page 3-16](#) or refer to [section 2.5, I/O Connections, on page 2-14](#) for relay wiring). This relay cannot be programmed for more than one function.

3.15 Time Setpoint

The Time Setpoint provides a convenient way to signal a timed event when Relay 2 (RL2) is set to TIME in the System menu. After a programmed time period (TIME SET), the Time SP indicator illuminates and Relay 2 activates. Relay 2 will deactivate and the time will reset when **Zero** is pressed.

To program the Time Setpoint:

- 1 Press **Program** to enter Program mode.
- 2 Press **Prev** to enter the System menu.
- 3 Press **Next** until RL2 is displayed on Display 1.
- 4 Rotate the **Control Knob** clockwise to select TIME. Press the **Control Knob** to accept the value.
- 5 Press **Program** to exit the System menu and return to Normal mode.
- 6 Press **Program** to return to Program mode.
- 7 Rotate the **Control Knob** to select the desired film (1 to 99), then press the **Control Knob** or **Next** to display the Film menu for the selected film.
- 8 Press **Next** until TIME SET is displayed on Display 1.
- 9 Rotate the **Control Knob** to edit the TIME SET value displayed on Display 2 and press the **Control Knob** to accept the value.
- 10 Press **Program** to exit the Film menu and return to Normal mode.

NOTE: Relay 2 is a multi-function relay. It can be programmed as a dual sensor shutter to activate when a programmed time has elapsed, or as a Sensor 2 shutter relay. The function of Relay 2 is set in the System menu RL2 parameter (refer to [section 3.5 on page 3-6](#) for more information about SQM-160 System parameters or see [section 3.19 on page 3-18](#) for more information about SQM-160 relay functions).

3.16 Thickness Setpoint

The Time Setpoint provides a convenient way to signal a thickness based event when SAMPLING is set to OFF in the System menu. When the programmed thickness is reached, the Thick SP indicator illuminates and Relay 4 deactivates. Press **Zero** to deactivate the relay and zero thickness.

NOTE: Thickness Setpoint is independent of Final Thickness, which always closes the source shutter.

To program the Thickness Setpoint:

- 1 Press **Program** to enter Program mode.
- 2 Press **Prev** to enter the System menu.
- 3 Press **Next** until SAMPLING is displayed on Display 1.
- 4 Rotate the **Control Knob** clockwise to set SAMPLING to OFF. Press the **Control Knob** to accept the value.
- 5 Press **Program** to exit the System menu and return to Normal mode.
- 6 Press **Program** to return to Program mode.
- 7 Rotate the **Control Knob** to select the desired film (1 to 99), then press the **Control Knob** or **Next** to display the Film menu for the selected film.
- 8 Press **Next** until THK SET, not FINL THK, is displayed on Display 1.
- 9 Rotate the **Control Knob** to edit the THK SET value displayed on Display 2. Press the **Control Knob** to accept the value.
- 10 Press **Program** to exit the Film menu and return to Normal mode.

NOTE: Relay 4 is a dual function relay. It can be programmed either for Rate Sampling or for as a Thickness Setpoint relay (see [section 3.14, Rate Sampling, on page 3-14](#) or refer to [section 2.5, I/O Connections, on page 2-14](#) for relay wiring). This relay cannot be programmed for more than one function.

3.17 Simulate Mode

In Simulate mode, SQM-160 simulates attached sensors and provides a simplified way to become familiar with the SQM-160 front panel controls and programming. It is possible to open or close the shutter to simulate deposition, zero readings, and display crystal life. It is also possible to test the Time and Thickness Setpoint relays and indicators.

To enter Simulate mode:

- 1 Press **Program** to enter Program mode.
- 2 Press **Prev** to enter the System menu.
- 3 Press **Next** until SIM MODE is displayed on Display 1.
- 4 Rotate the **Control Knob** to set SIM MODE to ON or OFF.
- 5 Press the **Control Knob** to accept the value.
- 6 Press **Program** to exit the System menu and return to Normal mode.

3.18 Defaulting the Memory



CAUTION

Performing this procedure will default SQM-160 to factory settings and delete all parameters set by the user. Do not perform this procedure before creating a backup configuration file using SQM-160 Comm software.

- 1 Turn **ON** SQM-160. Immediately press and hold the buttons described in either **1a** or **1b**, depending on the SQM-160 firmware version.

NOTE: The buttons must be pressed and held immediately after positioning the ON/OFF switch to **ON** or the procedure will not work.

- 1a** To clear only Film parameters:

Press and hold **ZERO + XTAL LIFE + SHUTTER** while SQM-160 turns **ON**. Continue holding and proceed to step 2.

- 1b** To clear only System parameters (firmware version v4.10 and higher):

Press and hold **ZERO + XTAL LIFE + SHUTTER + CONTROL KNOB** while SQM-160 turns **ON**. Continue holding and proceed to step 2.

- 2 Continue to hold the buttons from **1a** or **1b** until **ERROR 00** is displayed, briefly followed by SQM-160 operating display. If parameters have not been defaulted and ERROR 00 did not display, return to step 1.
- 3 Turn SQM-160 **OFF**, then **ON**. SQM-160 should now turn **ON** without displaying errors.

NOTE: Defaulting the SQM-160 memory can also be done using the SQM-160 Comm software (see [section 4.6 on page 4-11](#)).

3.19 Relay Operation

The four SQM-160 relays are physically single-pole, normally-open (1FormA) relays. Each relay can be programmed to act as either normally-open or normally-closed during SQM-160 operation.

NOTE: All relays will open if SQM-160 is turned **OFF** or loses power (refer to [section 2.5 on page 2-14](#) for relay wiring).

To set the relay operating mode:

- 1 Press **Program** to enter Program mode.
- 2 Press **Prev** to enter the System menu.
- 3 Press **Next** until RELAYS displays on Display 1.
- 4 Press the **Control Knob** to display Relay 1 on Display 1.
- 5 Rotate the **Control Knob** to select **nO** (normally open) or **nC** (normally closed). Press the **Control Knob** to accept the value and display the next relay.
- 6 Repeat step 4 for each of the four relays.
- 7 Press **Program** to exit the System menu and return to Normal mode.

3.20 Analog Output Configuration

SQM-160 features analog outputs that will produce a 0 to 5 V (dc) representative of the current rate or thickness. Analog outputs must be set to match the device that will be attached to the Rate or Thickness output.

To set up the analog outputs in the System menu:

- 1 Press **Program** to enter Program mode.
- 2 Press **Prev** to enter the System menu.
- 3 Press **Next** until R/T BNDS is displayed on Display 1.
- 4 Press the **Control Knob** to display RATE MIN on Display 1.
- 5 Rotate the **Control Knob** to set the RATE MIN value appropriately for a 0 V (dc) output.
- 6 Press the **Control Knob** to save the value and display RATE MAX on Display 1.
- 7 Rotate the **Control Knob** to set the RATE MAX value appropriately for a 5 V (dc) output.
- 8 Press the **Control Knob** to save the value and display THICKMIN on Display 1.

- 9 Repeat steps 5 to 8 to adjust the Thickness output values (THICKMIN and THICKMAX).
- 10 Press **Program** to exit the System menu and return to Normal mode. (Refer to [section 3.5 on page 3-6](#) for more information on setting SQM-160 System parameters.)

3.21 Depositing a Film

After all Film and System menu parameters are entered, it is possible to deposit a film. Follow the procedure below to begin deposition.

1 Verify Sensor Operation

Verify that the Crystal Status indicator(s) for the measuring sensor(s) is illuminated and not flashing.

2 Display Rate/Thickness

Display 1 should display Rate on the left and Thickness on the right.

- ◆ If the Crystal Life display mode is active, press the **Xtal Life** button to return to Normal mode.
- ◆ If the Program mode is active, press **Program** to return to Normal mode.

3 Zero Thickness

If needed, press **Zero** to zero the Thickness reading.

4 Start Deposition

Apply power to the source evaporation supply. If the SQM-160 shutter relay is connected (refer to [section 2.5 on page 2-14](#)), press **Shutter** to open the source shutter and begin deposition.

Rate and Thickness displays should display non-zero values. If the Rate and Thickness displays continue to display zero, check the system setup to ensure evaporation is occurring and deposition material is reaching the sensor.

If the display is erratic or noisy, refer to the troubleshooting information found in [Chapter 6](#) or the sensor operating manual.

If the rate and thickness readings do not match expectations, refer to [section 3.4 on page 3-4](#) for information on setting Film parameters (Density, Z-Ratio (Z-Factor), Film Tooling) and [section 3.8 on page 3-11](#) for information on setting Sensor Tooling.

This page is intentionally blank.

Chapter 4

SQM-160 Comm Software

4.1 Introduction

SQM-160 Comm software communicates with SQM-160 to allow remote instrument setup and data logging.

Features include:

- ◆ Selecting a Film on SQM-160, then opening the shutter to start deposition.
- ◆ Viewing SQM-160 readings in both numerical and graphical format.
- ◆ Storing SQM-160 log data in a spreadsheet-compatible format.
- ◆ Creating and storing an unlimited number of film setups.
- ◆ Downloading films to and uploading films from SQM-160.
- ◆ Modifying the SQM-160 system setup parameters.

NOTE: This chapter discusses the functionality of SQM-160 Comm V2 software version 2.60. Previous versions of SQM-160 Comm software may differ in form and function. Refer to an older manual revision for information about previous software versions.

Consult [Chapter 5, Communications](#) for information on connecting to an SQM-160 and establishing communication with this program.

4.2 Installation

The following instructions are for installation of SQM-160 Comm software.

- 1** Click **Windows Explorer or File Explorer >> Computer >> (CD drive letter:) INFICON Technical Documentation>> SQM160 Monitor**.
- 2** Double-click **SQM 160 V2 v2.6.0 Setup.exe**.
- 3** The InstallShield Wizard will display.
- 4** Click **Next**.
- 5** Select **I accept the terms in the license agreement**.
- 6** Click **Next**.
- 7** Click **Next** to accept the default installation location or click **Change** to change the installation folder).
- 8** Click **Install** to start the software installation.

- 9 Click **Finish**. The **INFICON USB Installer - InstallShield Wizard** window will display.
- 10 Click **Next**.
- 11 Select **I accept the terms in the license agreement**.
- 12 Click **Next**.
- 13 Enter **User Name** and **Organization** information.
- 14 Click **Next**.
- 15 Click **Install**.
- 16 Click **Finish**. The **INFICON Thinfilm USB Device Driver Driver Installer** window will display.
- 17 Click **Next**.
- 18 Click **Finish**.

4.2.1 Update of an Older Version of SQM-160 Comm

If an older version of SQM-160 Comm software is being updated:

- 1 Navigate to **Windows Control Panel >> Programs**.
- 2 In Programs, select **SQM-160 Comm** and click **Uninstall** to remove the old version of SQM-160 Comm software.
- 3 Install the latest version of SQM-160 Comm software (refer to [section 4.2](#)).

NOTE: It may be necessary to remove previously installed USB drivers for the new drivers to install correctly. This is done using steps 1 to 3 above to uninstall any INFICON USB drivers or Silicon Laboratories USB drivers. **Silicon Laboratories USBXpress Device (Driver Removal)** is a common driver for previous devices.

4.3 Start the SQM-160 V2 Comm software.

For Windows 7

Click **Windows Start icon >> All Programs >> INFICON >> SQM-160 Comm V2.**

or

Double click the **SQM-160 Comm V2** shortcut icon on the desktop.

For Windows 8

In the Start window, click the **SQM-160 Comm V2** icon.

If the **SQM-160 Comm V2** icon is not visible:

Click **Search >> Apps.**

Type **SQM-160** in the Search box.

Click the **SQM-160 Comm V2** icon.

The SQM-160 Comm Main window will display (see [Figure 4-1](#)).

4.4 Main Window

The Main window displays and graphs process data and allows navigation to other windows for editing process parameters (see Figure 4-1).

Figure 4-1 SQM-160 Comm Main window - online

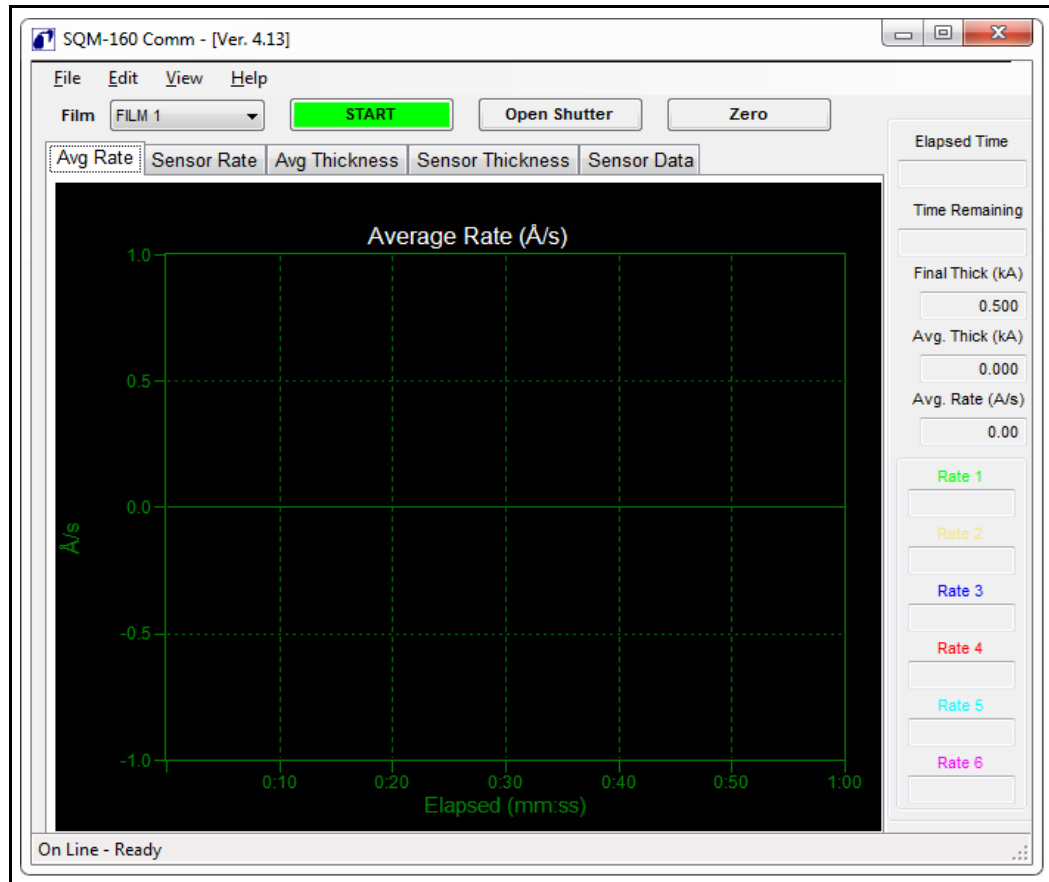

On program startup, SQM-160 Comm software attempts to find an SQM-160 using the last communications port settings. It may take a few seconds to establish a connection. At this time, **Initializing...** will be displayed at the bottom of the Main window.

- ◆ If SQM-160 Comm software is able to connect to SQM-160, the SQM-160 firmware version is displayed at the top of the Main window and **On Line - Ready** is displayed at the bottom of the Main window (refer to Figure 4-1).

- ◆ If SQM-160 Comm software is unable to connect to SQM-160, control functions are disabled, **Off Line - Check communications** is displayed at the bottom of the Main window, and **Off Line** is displayed at the top of the Main window (see Figure 4-2).

Figure 4-2 SQM-160 Comm Main window - Off line

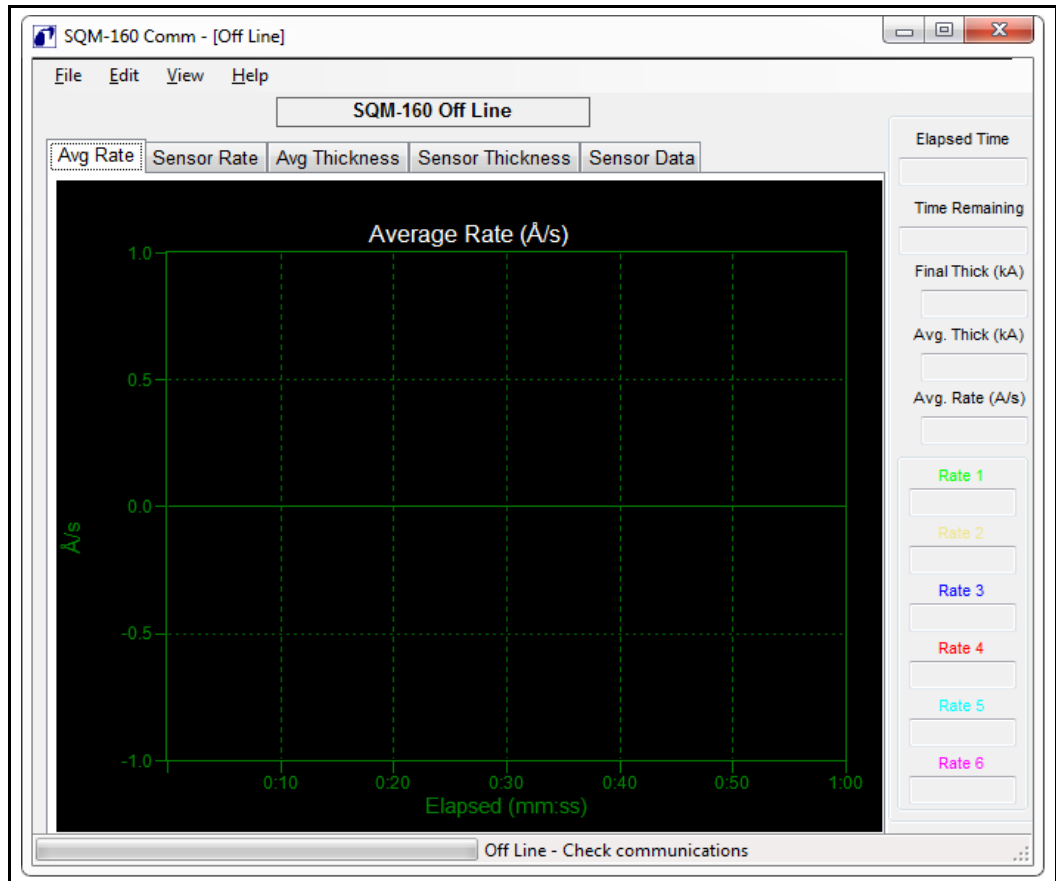

See section 4.8, Communications Setup Window, on page 4-17 for more information on establishing communications.

4.4.1 Menu Bar Functions

The Main window features a menu bar with drop-down menu lists (File, Edit, View, and Help). All system and process configuration is accessed through these menus. Some menu selections are not available during data acquisition or if SQM-160 communications are not established.

4.4.1.1 File Menu

Data Log Opens the Data Log window for configuration of the SQM-160 Data Log function (see [section 4.5 on page 4-9](#)).

Print Prints the Sensor Data tab, Avg Rate tab, Sensor Rate tab, Avg Thickness tab, and Sensor Thickness tab. When initially clicked, opens the Print window for configuration of printers and printing preferences.

NOTE: Print will not display the Print window a second time while SQM-160 Comm software is open. Exit and open SQM-160 Comm software to display the Print window for editing configuration of printers and printing preferences.

Screen Image to File

Current View to JPG Saves a screenshot of the currently opened tab in .jpg format to the selected folder. If a folder has not been selected using **Select JPG Folder**, images will be saved to the INFICON SQM-160 directory.

All Views to JPGs Saves a screenshot of all tabs in .jpg format to the selected folder. If a folder has not been selected using **Select JPG Folder**, images will be saved to the INFICON SQM-160 directory.

Select JPG Folder Allows for selection of a default save location for all Screen Image files.

Exit Exits the program.

4.4.1.2 Edit Menu

- Films** Opens the Films window for editing of Film parameters (see [section 4.6 on page 4-11](#)).
- System** Opens the System Parameters window for editing of System parameters (see [section 4.7 on page 4-15](#)).
- Communications** Opens the SQM-160 Comm Setup menu for editing of remote communications settings (see [section 4.8 on page 4-17](#)).
- Graph Settings** Opens the Configure Graph(s) window for editing of graph settings (see [section 4.9 on page 4-21](#)).

4.4.1.3 View Menu

The View menu selects which graph is viewed and also what information is displayed on right side of the Main window. A check mark indicates the currently selected information. Graph selection can also be done by clicking on the tabs at the top of each graph (see [section 4.4.2](#)).

- Average Rate Graph** Displays a graph of the average rate of all active sensors.
- Sensor Rates Graph** Displays a graph of the individual rate of each active sensor.
- Average Thickness Graph** Displays a graph of the average thickness of all active sensors.
- Sensor Thickness Graph** Displays a graph of the individual thickness of each active sensor.
- Sensor Rates Display** Displays individual sensor rates in Å/s on the right side of the Main window.
- Sensor Thickness Display** Displays individual sensor thicknesses in kÅ on the right side of the Main window.
- Sensor Frequency Display** Displays individual sensor frequencies in Hz on the right side of the Main window.

4.4.1.4 Help Menu

- About** Displays the SQM-160 About window (see [section 4.10 on page 4-23](#)).
- Help** Function not available.

PN 074-511-P1E

4.4.2 Main Window Control Functions

- Film** This drop-down list selects the film on SQM-160 that will be used for rate/thickness measurements.
- Start/Stop** Starts or stops SQM-160 data acquisition. Graphing and display of readings from SQM-160 starts/stops immediately when this control is toggled. When data logging is configured (see [section 4.5](#)), logging begins when **Start** is clicked.
- Open/Close Shutter** Toggles the SQM-160 shutter relay. Opening the shutter automatically starts SQM-160 data acquisition. However, closing the shutter does not automatically stop data acquisition.
- Zero** Zeros the thickness reading on SQM-160.

The following Main window features display readings from SQM-160:

- Graph & Sensor Data Tabs** Displays readings from SQM-160. Use the tabs to select the desired type of information to display.
- Avg Rate** Displays a graph of the average rate of all active sensors.
- Sensor Rate** Displays a graph of the individual rate of each active sensor.
- Avg Thickness** Displays a graph of the average thickness of all active sensors.
- Sensor Thickness** Displays a graph of the individual thickness of each active sensor.
- Sensor Data** Displays average and individual sensor rate, thickness, and frequency in a table format.
- Elapsed Time** Displays the elapsed time since **Start** was clicked.
- Time Remaining** Displays the calculated deposition time remaining based on the current thickness, current rate, and final thickness setpoint.

PN 074-511-P1E

- Final Thickness** The desired deposition thickness for the selected film. Final thickness can be edited in the Film window (see [section 4.6 on page 4-11](#)).
- Average Thickness** The current film thickness, based on the average of all sensors assigned to the selected film.
- Average Rate** The current deposition rate, based on the average of all sensors assigned to the selected film.
- Rate 1 to 6** The individual sensor rate readings.

NOTE: Rate 1 to 6 can be replaced with Thickness 1 to 6 or Frequency 1 to 6 using the View menu (refer to [section 4.4.1.3 on page 4-7](#)).

4.5 Data Log Window

SQM-160 Comm software has the ability to log data to a .txt file at user-specified time intervals. Click **File >> Data Log** on the Main window to display the Data Log window. The Data Log window configures the SQM-160 Comm software data logging function (see [Figure 4-3](#)).

NOTE: Once configured, data logging will not begin until **Start** is clicked.

Figure 4-3 Data Log window

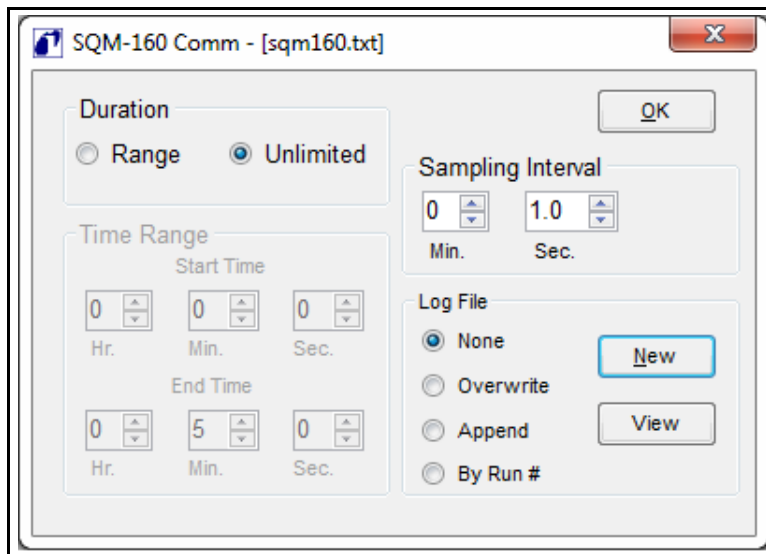

PN 074-511-P1E

Data is saved in tab delimited .txt file format for easy viewing or importing into a spreadsheet (see Table 4-1).

Table 4-1 Data in tab delimited .txt file format

Start:	Date: 9/10/2013 Time: 14:04:41 Film: ALUM				
Time	AvgThk	AvgRate	Thk1	Rate1
0.00	0.000	1.10	0.000	1.10	
0.50	0.000	1.11	0.000	1.11	
1.00	0.001	1.10	0.001	1.10	
1.50	0.001	1.10	0.001	1.10	
2.00	0.002	1.10	0.002	1.10	
.....					
End:	Date: 9/10/2013 Time: 14:04:44 Film: ALUM				

4.5.1 Log File Pane

Select the type of log file, filename and location for the data log, or view the currently saved data log.

- None** Data logging is disabled.
- Overwrite** The log file will be overwritten each time data logging is started with Start or Open Shutter on the Main window.
- Append** Data is added to the end of the log file each time data logging is started with Start or Open Shutter.
- By Run #** A new log file is created each time logging is started. The run number is added to the end of each filename.
- New** Displays a file open dialog box to allow selection or creation of a new log file and/or path.
- View** Displays the current log file using the default Windows text file viewer.

4.5.2 Duration Pane

Select the duration of the data log.

Unlimited Allows the data log to continue as indefinitely.

Range The log will start and end according to the Time Range settings (see [section 4.5.3](#)).

4.5.3 Time Range Pane

Set the start and end time for the data log.

NOTE: Settings in the Time Range pane are only available if **Range** is selected in the Duration pane.

Start Time The elapsed time when data logging begins. Set the value in hours, minutes, and seconds.

End Time The elapsed time when data logging ends. Set the value in hours, minutes, and seconds.

4.5.4 Sampling Interval Pane

The Sampling Interval is the elapsed time between data log entries in minutes and seconds. An interval value of zero causes data to be logged as quickly as possible. This time will vary depending on system configuration.

4.6 Films Window

Click **Edit >> Films** on the Main window to display the Films window. This window allows films to be created, edited, and saved to a file or transferred to/from SQM-160. The films are stored in an SQM-160 configuration file in an Extensible Markup Language (XML) format, **Monitor.xml**, in the SQM-160 Comm software program directory by default.

The name of the .xml file being used to store films is displayed at the top of the Films menu. Films uploaded from SQM-160 are stored automatically in a file named **UploadData.xml**.

Figure 4-4 Films window

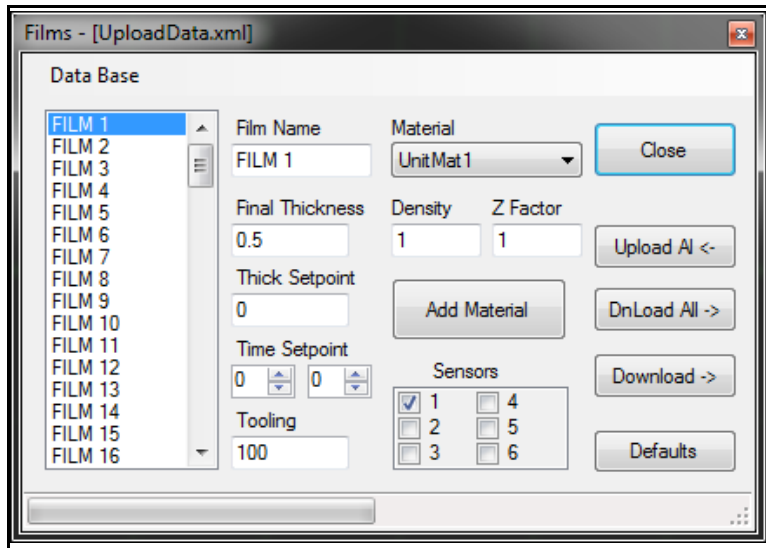

- Data Base** Click to create a new configuration file, save the current setting to a new or existing configuration file, or open an existing configuration file.
- Films List** Lists the films (1 to 99) available for editing and download. Click **Upload AI <-** to update the Films List with films currently stored in SQM-160.
- Close** Exits the Films window and saves changes to the current .xml file.
- Upload AI <-** Reads films stored in SQM-160 to the Films List and automatically saves the read films to the file **UploadData.xml**.
- DnLoad All ->** Saves all films to SQM-160.
NOTE: Clicking **DnLoad All ->** will overwrite any films stored in SQM-160.
- Download ->** Saves the film parameters currently displayed to SQM-160.
NOTE: Clicking **Download ->** will overwrite any films stored in SQM-160.
- Defaults** Resets film and system parameters to default values.
- Add Material** Enter a new material into the Materials list.

The following editable film parameters pertain to the selected film in the Films List.

Film Name The name that is displayed in the Films List and in the SQM-160 Film menu. Names are limited to eight alphanumeric characters. No special characters are allowed.

NOTE: While SQM-160 does not allow spaces or lowercase characters in film names (see [section 5.4.2 on page 5-13](#)), it is acceptable to enter spaces and lowercase characters using SQM-160 Comm software. SQM-160 Comm software will convert characters to the correct format when downloading to SQM-160.

Final Thickness The desired film thickness setpoint. When the Final Thickness is reached, the SQM-160 shutter relay deactivates (closes the source shutter) and Final Thk indicator illuminates on the SQM-160 front panel. Values from 0 to 9999 kÅ are valid.

Thick Setpoint A thickness setpoint that closes the Thickness Setpoint relay and illuminates the Thk SP indicator on the SQM-160 front panel. This does not affect the source shutter. Values from 0 to 9999 kÅ are valid.

Time Setpoint Elapsed time that closes the Time Setpoint relay and illuminates the Time SP indicator on the SQM-160 front panel. Values from 00:00 to 99:59 mm:ss are valid.

Tooling Film Tooling Factor. Correction for differences in material deposited on the substrate and material deposited on the sensor(s). Film Tooling Factor applies to all sensors used for the selected film. Values from 10 to 399 are valid.

NOTE: The System Parameters window (see [section 4.7 on page 4-15](#)) contains tooling corrections for individual sensors. Consult [Chapter 7, Calibration Procedures](#) for more details on setting tooling factors.

- Material** List of available materials. Materials named **UnitMat#** are unknown materials uploaded from SQM-160. Selecting a material in this list updates Density and Z factor parameters with stored values for that material.
- Density** Density of the selected material. Values from 0.5 to 99.99 g/cm³ are valid.
- Z Factor (Z-Ratio)** Z-Ratio of the selected material. Values of 0.10 to 10.00 are valid.
- NOTE:** Density and Z-Ratio is listed for many common materials in the [Material Table on page A-1](#). See [section 7.4 on page 7-3](#) for information on determining the Z-Ratio experimentally for unknown materials.
- Sensors** Selects the sensors that are used in calculating rate/thickness for this film. If more than one sensor is selected, the average reading of the selected sensors is used to determine rate and thickness.

4.7 System Parameters Window

Click **Edit >> System** on the Main window to display the System Parameters window. This window allows system parameters to be sent to or read from a connected SQM-160. These parameters appear in the SQM-160 System menu (refer to [section 3.5 on page 3-6](#)). System parameters are not saved in the .xml configuration file (refer to [section 4.6 on page 4-11](#)).

Figure 4-5 System Parameters menu

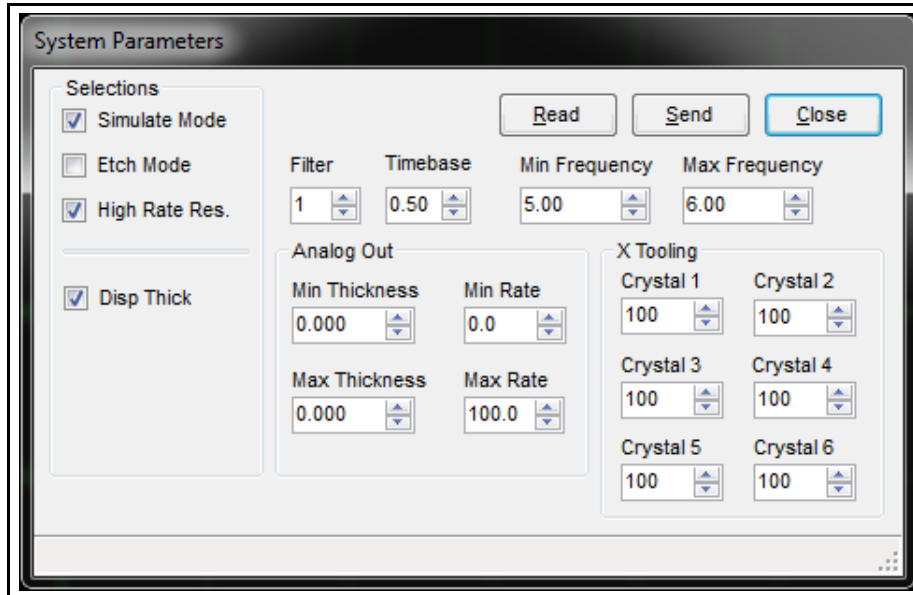

Read Reads the System Parameters from SQM-160.

Send Sends the current System Parameters to SQM-160.

Close Exits the System Parameters window.

NOTE: Changes will not be saved unless **Send** is clicked before **Close**.

Selections:

Simulate Mode Select to enable Simulate Mode. In Simulate Mode, SQM-160 simulates sensor inputs and deposition rates (for test purposes only).

Etch Mode Select to enable Etch Mode. Sets the rate and thickness to negative values for etching applications.

- High Rate Res.** Select to enable high rate resolution display (0.01 Å/s). Clear to use low rate resolution display (0.1 Å/s).
- NOTE:** Using High Rate Resolution does not increase the internal precision of SQM-160. This option only affects the number of displayed digits.
- Display Thickness** When selected, DSP on the SQM-160 System menu is set to THCK. If DSP is set to NANM, FREQ, or MASS, **Display Thickness** is cleared.
- NOTE:** This parameter cannot be cleared from SQM-160 Comm software. It can only be read from SQM-160, selected if cleared, and written to SQM-160.
- Filter** The number of readings averaged for the rate display. Values of 1 to 20 are valid. A value of 1 indicates no averaging.
- NOTE:** The number of readings averaged per second is dependent on the Timebase setting.
- Timebase** The time for a single measurement. Values of 0.10 to 2.0 seconds are valid.
- Min. Frequency** The minimum expected crystal frequency, typically 5 MHz for a 6 MHz crystal. Frequency readings below the minimum generate a crystal fail error. Values of 1.0 to 6.0 MHz are valid.
- Max. Frequency** The maximum expected crystal frequency, typically 6 MHz for a 6 MHz crystal. Frequency readings above the maximum generate a crystal fail error. Values of 4.0 to 6.5 MHz are valid.
- X Tooling** Tooling value assigned to each sensor. Applies to all films. Values of 10 to 399 are valid.
- Analog Out** Sets the full and zero output values for rate and thickness analog outputs. Min (Zero output) is the value for 0 V (dc) and Max (full scale output) is the value for +5 V (dc).

- Min Thickness** Thickness for zero output (0 V (dc)). Values of 0.000 to 9999 kÅ are valid.
- Max Thickness** Thickness for full scale output (+5 V (dc)). Values of 0.000 to 9999 kÅ are valid.
- Min. Rate** Rate for zero output (0 V (dc)). Values of 0.0 to 999.0 Å/s are valid.
- Max. Rate** Rate for full scale output (+5 V (dc)). Values of 0.0 to 999.0 Å/s are valid.

4.8 Communications Setup Window

Click **Edit >> Communications** on the Main window to display the SQM-160 Comm Setup window. The Comm Setup window allows for setup and troubleshooting of the SQM-160 remote communications connection.

Figure 4-6 Comm Setup window

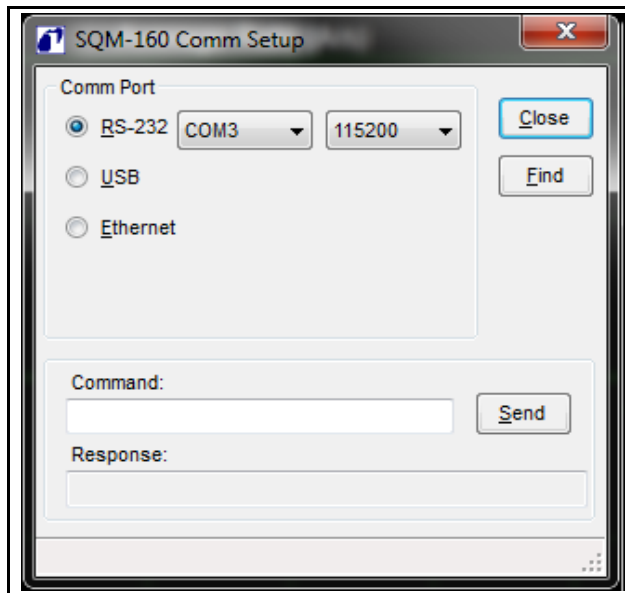

- Comm Port** Select method of communication: RS-232, USB, or Ethernet.
- RS-232** Select communications port connected to SQM-160 and baud rate. Baud rate must equal the BAUDRATE setting in the SQM-160 System menu (refer to [section 3.5 on page 3-6](#)).
- USB** Select the connected SQM-160 (for example, 91102).

Ethernet	Enter the Port number and Address for network communications (for example, Port 2101, Address 192.168.1.200).
Close	Exits SQM-160 Comm Setup window and saves communications settings.
Find	Click to establish communications with SQM-160 using the selected communications method.
Command	Enter a remote command and click Send to send to SQM-160 (see Chapter 5 for more information on remote commands).
Response	Displays the response to the command in the Command field after Send is clicked.
Send	Click to send communication command entered in the Command field. The response (or error) is displayed in the Response field.

4.8.1 Establishing Communications

To connect SQM-160 to a computer, a 9-pin male to 9-pin female straight-through RS-232 cable, USB cable, or Ethernet cable is required. An RS-232 cable is supplied with each SQM-160.

To establish communications using RS-232:

- ◆ Verify SQM-160 is turned on and connected to the computer with a straight-through cable.
- ◆ Select **RS-232** in the Comm Port pane of the SQM-160 Comm Setup window.
- ◆ Select the port number to match the computer port to which the RS-232 cable is attached.
- ◆ Select the Baud rate of the software equal to the BAUDRATE setting in the SQM-160 System menu.
- ◆ Click **Find** to test the connection. If communication is established successfully, **Found SQM-160 Ver. x.xx** is displayed at the bottom of the SQM-160 Comm Setup window.

To establish communications using USB:

- ◆ Verify SQM-160 is turned on and connected to the computer with a standard USB cable.
- ◆ Select **USB** in the Comm Port pane of the SQM-160 Comm Setup window.
- ◆ Click **Find** to test the connection. If communication is established successfully, **Found SQM-160 Ver. x.xx** is displayed at the bottom of the SQM-160 Comm Setup window.

To establish communications using Ethernet:

- ◆ Verify SQM-160 is turned on and connected to the computer with a standard (straight) Ethernet cable.
- ◆ Establish the appropriate computer network protocol (see [section 5.1.3.1 on page 5-2](#)).
- ◆ Select **Ethernet** in the Comm Port pane of the SQM-160 Comm Setup window.
- ◆ Enter the appropriate Port and IP address for the specific SQM-160 being connected. The default address is 192.168.1.200 and Port is 2101.
- ◆ Click **Find** to test the connection. If communication is established successfully, **Found SQM-160 Ver. x.xx** is displayed at the bottom of the SQM-160 Comm Setup window.

NOTE: More detailed information about the various communications protocols can be found in [section 5.1 on page 5-1](#).

4.8.2 Command Field

In the SQM-160 Comm Setup window, the Command field provides a command/response interface for testing SQM-160 remote commands (see [Figure 4-7](#)).

The remote communications protocol and commands are detailed in [section 5.3, SQM-160 Communications Protocol](#), on page 5-9.

Figure 4-7 Command and response example

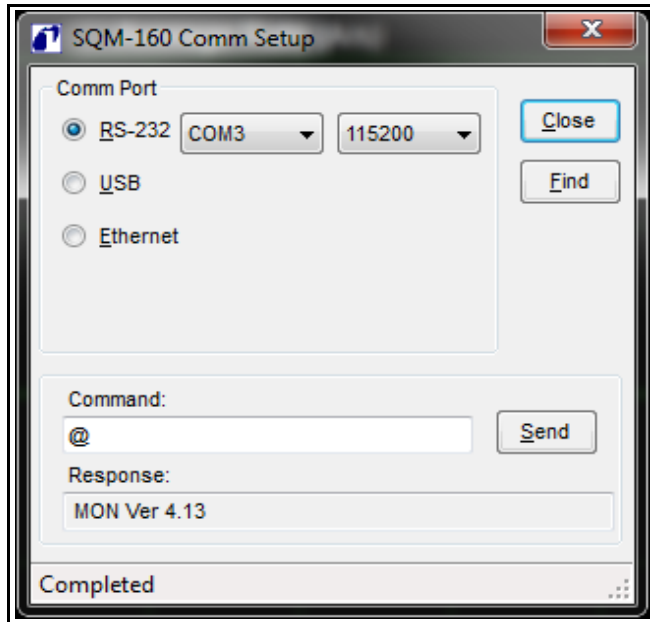

To use the Command field, insert only the Message (see [section 5.3.1 on page 5-9](#)). This does not include the Sync, Length, or CRC characters. In the example in [Figure 4-7](#), the @ command is used, so only the ASCII @ is entered in the Command field. SQM-160 Comm software automatically calculates and sends the Sync, Length, and CRC characters.

The Response field displays the communications response message from SQM-160 after sending a command using the Command field. The Response message in ASCII does not include Sync, Length, Message Status, or CRC characters.

4.9 Configure Graph(s) Window

Click **Edit >> Graph Settings** on the Main window to display the Configure Graph(s) window. This provides access to graph axis and grid settings.

Figure 4-8 Configure Graph(s) window

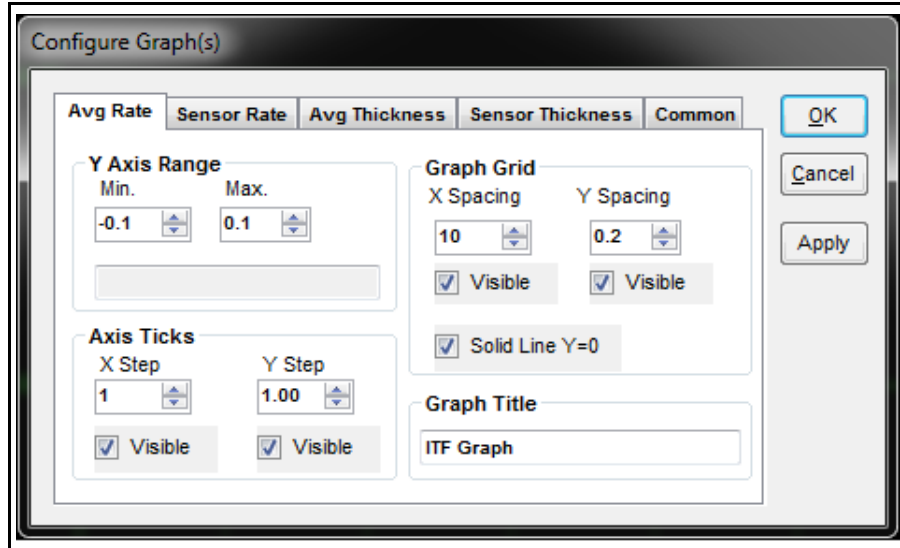

- OK** Click to save changes and exit the Configure Graph(s) window.
- Cancel** Click to cancel changes and exit the Configure Graph(s) window.
- Apply** Click to apply changes without exiting the Configure Graph(s) window.

The Configure Graph(s) window includes a settings tab for each graph type (Avg Rate, Sensor Rate, Avg Thickness, and Sensor Thickness) and a tab for settings common to all graphs.

The following are available in the **Common** tab.

- X Axis Width** Sets the total displayed width of the graph, in minutes and seconds. Values from 1:00 to 120:59 mm:ss are valid.
- X Text Interval** Sets the amount of time between X axis labels. Values from 0 to 480 seconds are valid.
- X Axis Scrolling** Sets how much blank area is introduced immediately when the graph scrolls (25, 50, 75, or 100%).
- Line Colors** Sets the color for each line that appears on the graph.

The following are available on the **Avg Rate**, **Sensor Rate**, **Avg Thickness**, and **Sensor Thickness** tabs.

Y Axis Range

Y Axis Min Sets the minimum value displayed on the Y axis of the graph, in Å/s or kÅ (for Rate or Thickness). Values from -10.00 to 100.00 are valid for Rate graphs and values from -100.00 to 100.00 are valid for Thickness graphs.

Y Axis Max Sets the maximum value displayed on the Y axis of the graph, in Å/s or kÅ (for Rate or Thickness). Values from 0.00 to 100.00 are valid.

Axis Ticks

X Step Sets the interval between X axis tick marks, in seconds. Values from 0 to 100 are valid.

Y Step Sets the interval between Y axis tick marks, in Å/s or kÅ (for Rate or Thickness). Values from 0.00 to 100.00 are valid.

Visible Select, to make tick marks visible. Clear, to make remove tick marks from the graph.

Graph Grid

X Spacing Sets the interval between X axis grid lines, in seconds. Values from 0 to 100 are valid.

Y Spacing Sets the interval between Y axis grid lines, in Å/s or kÅ (for Rate or Thickness). Values from 0.00 to 100.00 are valid.

Visible Select to make grid lines visible.
Clear to remove grid lines from the graph.

Solid Line Y = 0. Select to display a solid line where Y = 0.
Clear to display a dashed line where Y = 0.

Graph Title Enter the title of the graph to be displayed on the Main screen.

4.10 Help Menu

Click **Help >> About** on the Main window to display the About window, which provides program revision installation information (see [Figure 4-9](#)).

Figure 4-9 About window

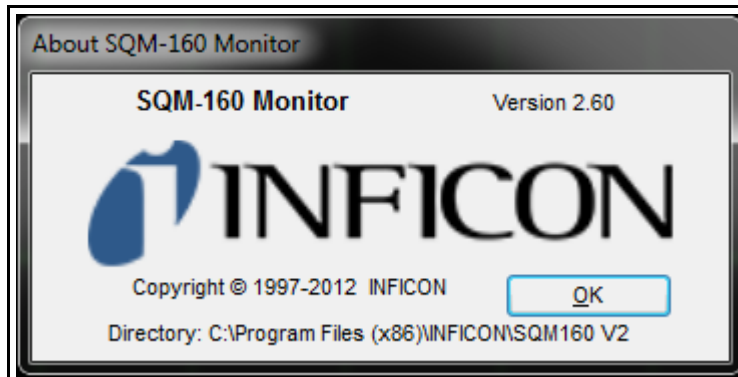

NOTE: **Help >> Help** does not have an assigned function.

This page is intentionally blank.

Chapter 5 Communications

5.1 Introduction

SQM-160 offers the following types of data communications hardware ports.

- ◆ Bit serial RS-232 port (standard)
- ◆ Ethernet port (optional)
- ◆ USB port (optional)

Both the host and server must have the same form of communications equipment and complementary setup. For serial communications, the baud rates and data word format must match.

The word format for bit serial lines (RS-232) is comprised of ten signal bits: eight data bits, one start bit, one stop bit, and no parity. The eight data bits contain a byte of information or character whose ASCII value ranges from 0 to 255.

5.1.1 RS-232 Serial Port

RS-232 serial communications are accomplished through an industry standard 9-pin female connector found on the SQM-160 rear panel (refer to [Figure 2-12 on page 2-11](#)). A mating male connector is required to attach a host interface. The host and SQM-160 can be separated by up to 15.2 m (50 ft.) using multiconductor shielded data cable.

For successful communications, the baud rate of the host and SQM-160 must match. Available baud rate options are: 2,400, 4,800, 9,600, 19,200, 38,400, 57,600, and 115,200 bps.

SQM-160 is configured as DCE (Data Communication Equipment).

NOTE: Unpredictable RS-232 hardware/software combinations may occasionally cause a command to not be recognized by SQM-160. Consequently, all communications should include an automatic retry procedure. If a command sent via RS-232 does not produce a response from SQM-160 within three seconds, it should be sent again.

5.1.2 USB Port

USB drivers are installed automatically with installation of the SQM-160 Comm software. Once the drivers are installed, Windows will find and install SQM-160 automatically when connected to a USB port.

NOTE: If SQM-160 is not found, it is possible to manually install the device from the 074-5000-G1 INFICON Thin Film Instrument and Sensor Manuals CD using the USB Installer v1.8.0 Setup file.

In the event an unsigned driver window displays during installation, click **Continue anyway**. Successful communication can be confirmed using the SQM-160 Comm software (refer to [section 4.8, Communications Setup Window, on page 4-17](#)).

5.1.3 Ethernet Port

For Ethernet communications, SQM-160 uses the static IP address 192.168.1.200. The optional Ethernet port supports only the Standard Ethernet TCP/IP protocol. SQM-160 will communicate using TCP/IP on TCP port number 2101.

The interface supports static addressing. DHCP is not supported. Ethernet parameters allow the IP address and the net mask to be set. A standard Ethernet cable is required to connect SQM-160 through a network or hub connection.

5.1.3.1 How to Set Up the Network Protocol on the Computer

An Internet Protocol (IP) address defines the computer on the Internet. Most computers are configured to automatically obtain the IP address from a server. Some computers will auto-configure and work with either straight or crossover Ethernet cable.

To communicate directly with SQM-160, the IP address must be manually configured on the computer, and the computer and SQM-160 must be connected with an Ethernet cable. To manually configure the IP address:

Follow [section 5.1.3.1.1](#) for instructions to access network settings in Windows XP. Follow [section 5.1.3.1.2](#) for instructions to access network settings in Windows 7 and Windows 8.

NOTE: The above instructions will set two values—the IP address and the Subnet mask—which may prohibit access to the Internet. If these values already contain information, make a record of the information for use in restoring the Internet connection.

NOTE: If the computer only has one Ethernet port (one network connection), setting the computer for direct communications will prohibit it from accessing the Internet until the setting is reversed.

SQM-160 ships with a pre-assigned address of 192.168.1.200. To communicate directly with SQM-160 from a computer, the computer must also be assigned a 192.168.1.xxx address, but *cannot* be set to 192.168.1.200. The examples in [section 5.1.3.1.1](#) and [section 5.1.3.1.2](#) use the address 192.168.1.201 for the computer. The Subnet mask 255.255.0.0 is sufficient.

5.1.3.1.1 Accessing Network Settings in Windows XP

- 1 Select **Network Connections** from either the Windows **Start** menu or from the **Control Panel** (see [Figure 5-1](#)).

Figure 5-1 Accessing Network Connections

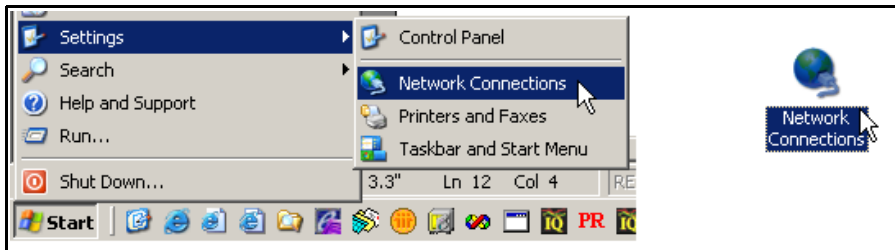

- 2 Select the **Local Area Connection** to be changed, right-click, and select **Properties** (see [Figure 5-2](#)).

Figure 5-2 Local Area Connection Properties

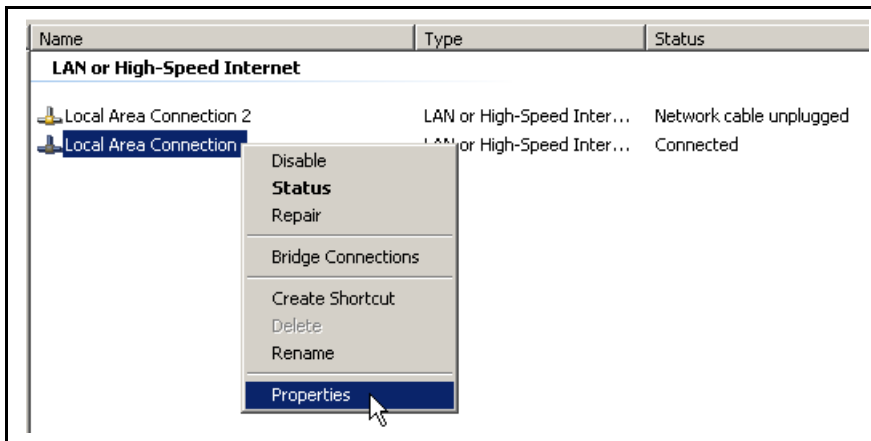

- 3 On the **General** tab, select **Internet Protocol (TCP/IP)** and click the **Properties** button (see [Figure 5-3](#)).

Figure 5-3 Internet Protocol (TCP/IP) Properties

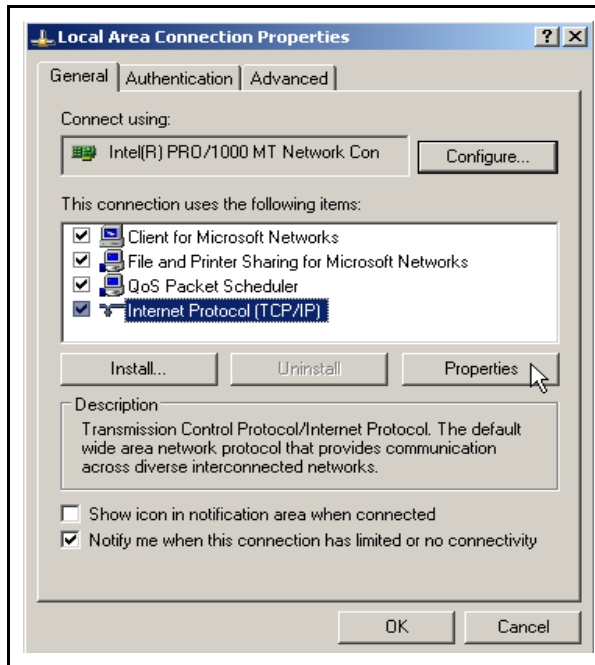

- 4 Select **Use the following IP address**, enter the **IP address** and **Subnet mask** (see [Figure 5-4](#)) and click **OK**. With this selection, the computer is assigned an IP address for communicating with SQM-160.

Figure 5-4 Entering the IP Address and Subnet mask

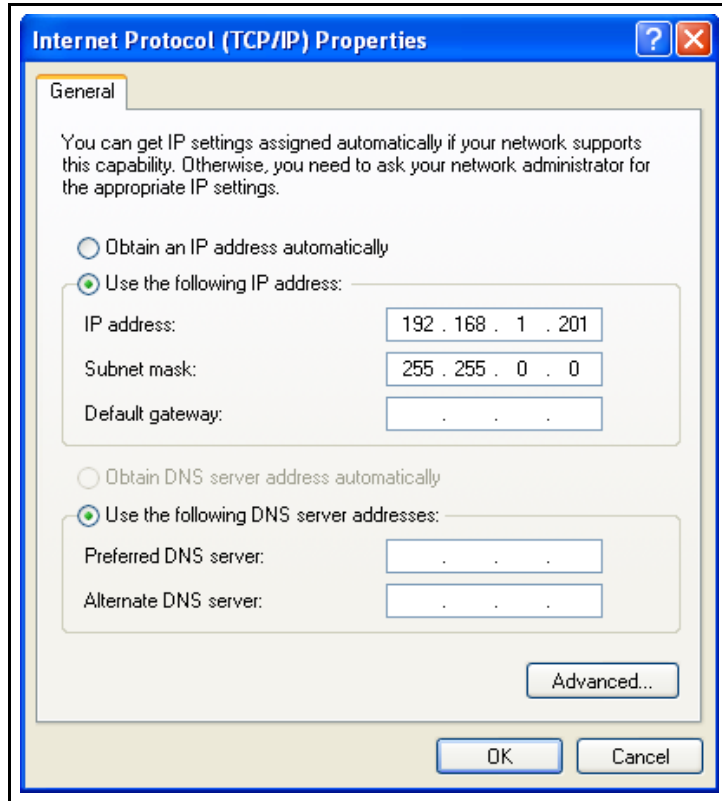

- 5 Click **OK** in all open dialog boxes to close out the Internet Protocol setup for the Local Area Connection. Open the SQM-160 software and confirm communications (refer to [section 4.8 on page 4-17](#)).

5.1.3.1.2 Accessing Network Settings in Windows 7 and Windows 8

- 1** Open the **Control Panel** (Start >> Control Panel) and Select **Network and Sharing Center**.
- 2** Click **Change adapter settings** on the left side panel (see Figure 5-5). This will open the **Network Connections** window.

Figure 5-5 Network and Sharing Center

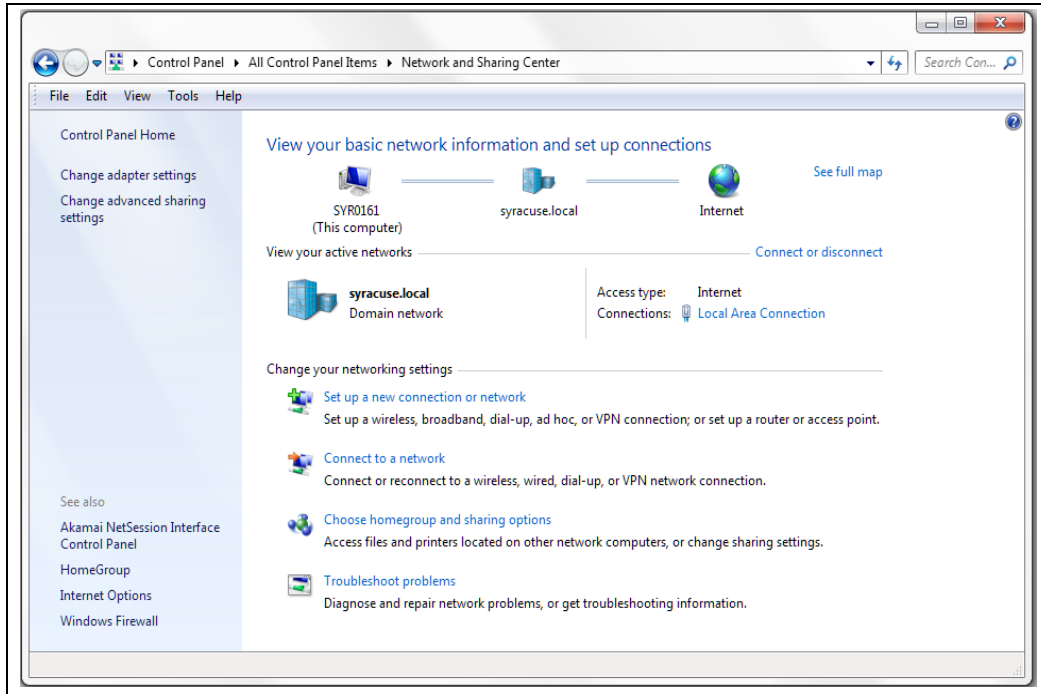

- 3** In the **Network Connections** window, right-click on the appropriate **Local Area Connection** and click **Properties** (see Figure 5-6).

Figure 5-6 Network Connections window

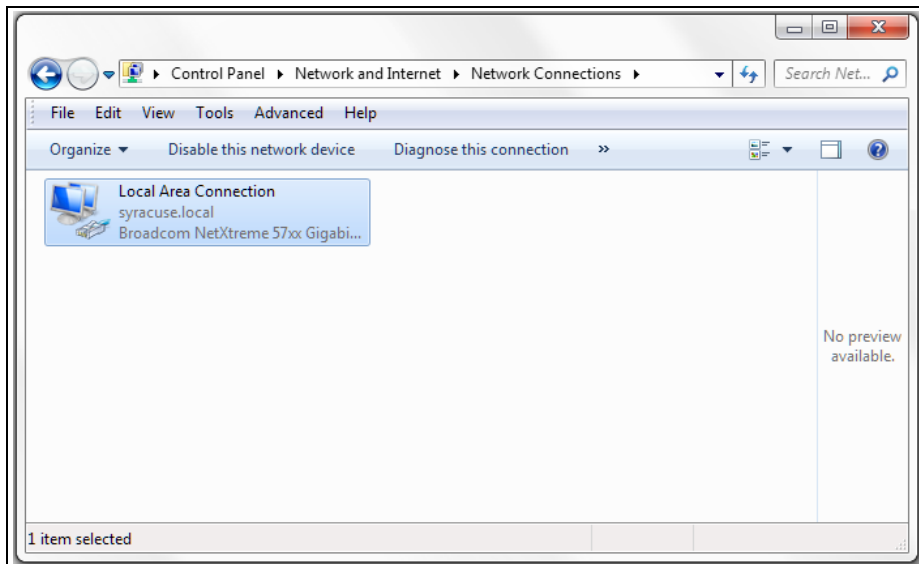

4 In the **Local Area Connection Properties**, select **Internet Protocol Version 4 (TCP/IPv4)** and click **Properties** (see [Figure 5-7](#)).

Figure 5-7 Local Area Connection Properties

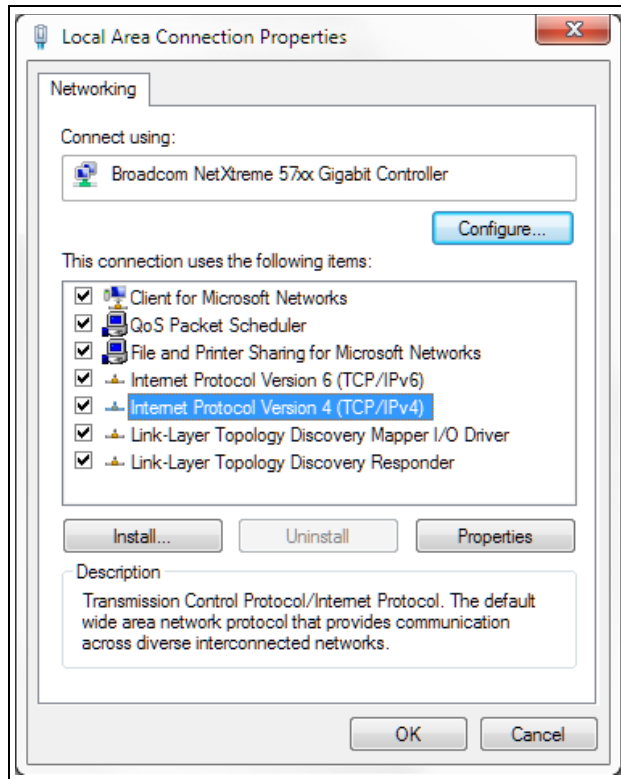

- 5 Select **Use the following IP address**, then enter the **IP address** and **Subnet mask** (see [Figure 5-8](#)) and click **OK**. With this selection, the computer is assigned an IP address to use when communicating with SQM-160.

Figure 5-8 Entering the IP Address and Subnet mask

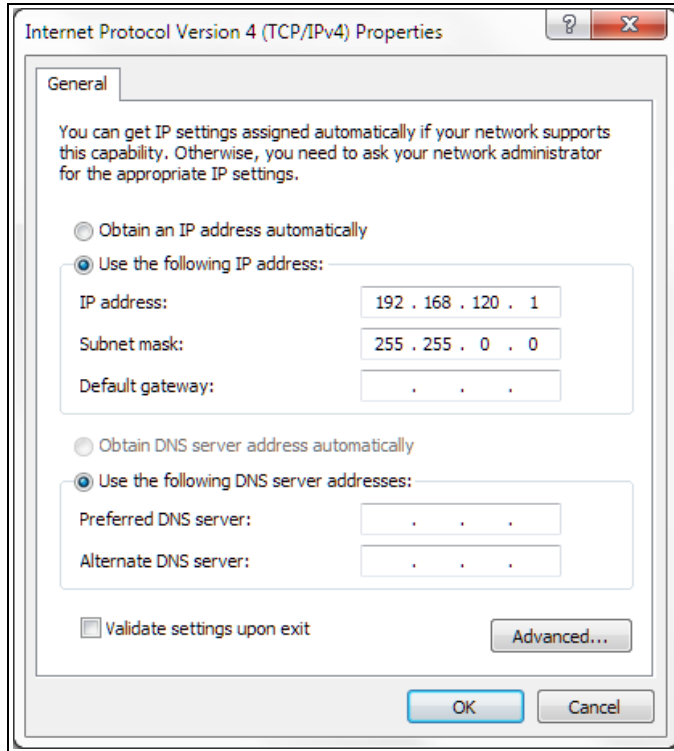

- 6 Click **OK** in all open dialog boxes to exit the Internet Protocol setup for the Local Area Connection. Open the SQM-160 Comm software and confirm communications (see [section 4.8 on page 4-17](#)).

5.1.3.2 How to change the SQM-160 IP address

The IP address can be changed using the Dgdiscvr program installed in the SQM-160 directory (typically C:/Program Files/INFICON/SQM-160 Comm) during SQM-160 Comm software installation.

To change the IP address:

- 1 Run **dgdiscvr.exe** and find **SQM-160**.
- 2 Double-click on **SQM-160**.
- 3 Enter User Name: **root** and Password: **dbps**.
- 4 Click **Login**.
- 5 Click **Configuration, Network, and Set**.
- 6 Change IP=192.168.1.200 to the new IP address.
- 7 Click **Apply**, then **Log Out**. The new IP address is now configured.

5.2 SQM-160 Comm Software

SQM-160 Comm software is on the Thin Film Instrument and Sensor Manuals CD (PN 074-5000-G1) that ships with SQM-160. This program provides real-time instrument control and process data logging. Data can be graphed and saved in a spreadsheet format.

For more information and installation instructions on SQM-160 Comm software, refer to [Chapter 4](#).

5.3 SQM-160 Communications Protocol

SQM-160 communicates with a host computer using an ASCII based protocol.

SQM-160 defaults to 19,200 baud, 8 data bits, and no parity. The baud rate can be changed in the SQM-160 System menu, but is always 8 data bits with no parity.

5.3.1 Command Packet (Host to SQM-160 Message)

<Sync character> <Length character> <Message> <CRC1><CRC2>

Sync The Sync character is an exclamation point (!). When this character is received, the communications for that packet is reset. The Sync character is not included in the CRC calculation.

NOTE: The Sync character (!) is reserved for the Sync usage, and cannot be used (sent) in any of the following message characters. It always marks the start of a new packet.

Length This is based on the decimal number of characters in the packet (excluding the Sync, Length, and CRC characters). This character has a decimal 34 added to it so there cannot be a Sync character (!) embedded in the packet.

NOTE: The maximum value for length should not exceed 190 (or 224 including the added 34).

Message Command (see [section 5.4](#)).

CRC Cyclic Redundancy Check (CRC) is a method to verify there are no errors in the packet. See [section 5.3.3 on page 5-11](#) for detailed instructions to calculate the CRC and [section 5.5 on page 5-22](#) for code examples.

PN 074-511-P1E

5.3.2 Response Packet (SQM-160 to Host Message)

<Sync character><Length character><Response Status character><Response Message><CRC1><CRC2>

- Sync** The Sync character is an exclamation point (!). Anytime this character is received, the communications for that packet is reset. The Sync character is not included in the CRC calculation.
- Length** This is based on the decimal number of characters in the packet (excluding the Sync, Length, and CRC characters). The response Length character has a decimal 35 added to the decimal count value instead of 34 like the Length character of the command packet.
- Response Status** This character indicates the status of the Command Packet message (see [Table 5-1](#)).
- Response Message** Command Response as received using the protocol described in [section 5.3 on page 5-9](#).
- CRC** Cyclic Redundancy Check (CRC) is a method to verify there are no errors in the packet. See [section 5.3.3](#) for detailed instructions to calculate the CRC and [section 5.5 on page 5-22](#) for code examples.

Table 5-1 Response Status

Response Status	Meaning
A	Command understood, normal response
C	Invalid command
D	Problem with data in command

PN 074-511-P1E

5.3.3 Calculating the CRC

The following algorithm is used to compute the Cyclic Redundancy Check (CRC):

NOTE: The Sync character and CRC are not included in the CRC calculation. All other characters should be included.

- 1** The CRC register (16 bits) is initialized to hexadecimal 3FFF.
- 2** Each 8 bit character in the packet is examined and added to the CRC in the following manner (excluding the Sync character):
 - 2a** The character byte is exclusive OR'd (XOR) with the least significant byte of the CRC register with the result replaced in the CRC register least significant byte. The most significant byte remains unchanged (one time per character byte).
 - 2b** Perform the following loop eight times:
 - 2bi** Preserve state of least significant bit (LSB) of the CRC register, named Cy.
 - 2bii** The CRC register is shifted one bit position to the right with a zero shifted into the most significant bit (MSB).
 - 2biii** If bit position 0 has a value of 1 before each shift (Cy=1), the CRC is exclusive OR'd with hexadecimal 2001 with the result replaced in the CRC register.
- 3** Mask the contents of the CRC register by logical AND with 3FFF hexadecimal and save the result into the CRC register.
- 4** The CRC register contains 14 significant bits. This is split into two pieces of 7 bits each to send at the end of the packet as CRC1 and CRC2. A decimal 34 (hexadecimal 22) is added to each CRC piece in order to avoid there being an embedded sync character.
 - 4a** Extract by masking with hexadecimal 7F the LSB 6 to 0 of the CRC register and add a decimal 34 (hexadecimal 22). This is CRC1.
 - 4b** Extract bits 13 to 7 of the CRC register, shift right seven times, and add a decimal 34 (hexadecimal 22). This is CRC2.

CRC code examples can be found in [section 5.5, CRC Examples, on page 5-22](#).

NOTE: CRC1 and CRC2 in the sent/received examples are decimal values 34 to 161 (see [section 5.4](#)).

5.4 Commands

SQM-160 uses several command types.

Query Returns the requested information about parameter settings from SQM-160.

Update Updates parameters in SQM-160.

Remote Performs an action.

Status Reads system status information.

Several commands can act as more than one command type, depending on how they are sent. For example, the **A** command can be used to query or update Film parameters.

Table 5-2 SQM-160 commands

Command	Command Type	Parameters Set/Returned or Function
@	Query	SQM-160 Version
A	Query/Update	Film Parameters
B	Query/Update	System 1 Parameters
C	Query/Update	System 2 Parameters
D	Update	Set Active Film
J	Query	Number of Installed Sensor Channels
L	Status	Current Sensor Rate
M	Status	Current Average Rate
N	Status	Current Sensor Thickness
O	Status	Current Average Thickness
P	Status	Current Sensor Frequency
R	Status	Crystal Life
S	Remote	Zero Average Thickness and Rate
T	Remote	Zero Time
U	Remote/Status	Toggle Source Shutter Open/Close Query Source Shutter State
W	Status	Rate, Thickness, Frequency
Y	Status	Power-Up Reset Flag State
Z	Update	Default All Parameters

NOTE: In the command details below, an underscore () indicates a space in the sent message.

5.4.1 Command: @

Command Type	Query
Description	Returns the firmware version number.
Command Structure	@
Parameters	None
Example:	
Sent	!#@(79)(55)
Received.	!0AMON_Ver_4.13(85)(119)

5.4.2 Command: A

Command Type	Query/Update
Description	Query or update Film parameters. Available parameters include Film Name, Density, Film Tooling, Z-Ratio, Final Thickness, Thickness Setpoint, Time Setpoint, and Sensor Average.
Command Structure	
Query	A<Film number>?
Update	A<Film number><Film name>_ <Density>_<Film Tooling>_<Z-factor>_ <Final Thickness>_<Thickness Setpoint>_ <Time Setpoint>_<Sensor Average>
Parameters	
Film number	1 to 99, 0 queries or updates current film Encoded as an ASCII character (decimal 49 to 147).
Film name.	8-character film name. Must be all uppercase alphabetic or numeric 0 to 9. No special characters except underscore (_) can be used to embed spaces. The first space delimits the name field, if less than eight characters.
Density	0.50 to 99.99 (g/cm ³)
Film Tooling	10 to 399 (%)
Z-Ratio	0.10 to 9.999
Final Thickness.	0.000 to 9999.000 (kÅ)

PN 074-511-P1E

Thickness Setpoint 0.000 to 9999 (kÅ)
 Time Setpoint 0:00 to 99:59 (mm:ss)
 Sent/received in integer seconds (0 to 5999).

Sensor Average The decimal equivalent of a binary number indicating which sensors are active for the Film. Each set bit indicates an active sensor. See [Table 5-3](#) for Bit/Sensor correlations.

Example: Decimal 12 = 00 1100 binary indicating sensors 3 and 4 are set for the Film.

Table 5-3 Sensor average bit assignments

Value	Bit	Sensor number
1	0	1
2	1	2
4	2	3
8	3	4
16	4	5
32	5	6

Example (query)

Sent !%A1?(46)(149)
 Received !0AFILM 1__1.00_100_1.000_33.380__
 0.000_0_1(79)(59)

Example (update)

Sent IKA1GOLD__1.23_150_1.23_1.234_
 1.234_0_12(140)(40)
 Received !\$A(53)(151)

NOTE: Film name should not contain more than two consecutive spaces within the eight character limit.

5.4.3 Command: B

Command Type Query/Update
 Description Query or update System 1 parameters. Available parameters include Time Base, Simulate Mode, Display Mode, Rate Resolution, Rate Filter, and Crystal Tooling for each sensor.

Command Structure

Query B?
 Update B_<Time Base>_<Simulate Mode>_<Frequency Mode>_<Rate Resolution>_<Rate Filter>_<Crystal Tooling1>_<Crystal Tooling2>_<Crystal Tooling3>_<Crystal Tooling4>_<Crystal Tooling5>_<Crystal Tooling6>_

Parameters

Time Base. 0.10 to 2.00 (s).
 Simulate Mode 0 or 1. 0 indicates simulate is OFF. 1 indicates simulate is ON.
 Display Mode 0 to 3, indicating the format of the Rate/Thickness display. See [Table 5-4](#) for number/display correlations.

Table 5-4 Display mode number codes

Display Mode Number	Rate, Thickness Format
0	Å/s, kÅ
1	nm/s, μm
2	Frequency only (Hz)
3	ng/cm ² /s, μg/cm ²

Rate Resolution 0 or 1. 0 indicates low display resolution (0.1 Å/s). 1 indicates high display resolution (0.01 Å/s).
 Rate Filter 1 to 20 (readings)
 Crystal Tooling 10 to 399 (%). Must be set for each sensor (integer values).

PN 074-511-P1E

Example (query)

```
Sent ..... !B?(93)(116)
Received..... !JA_0.10_1_0_0_1_100_100_100_100_100_
100_(119)(50)
```

Example (update)

```
Sent ..... !HB_0.25_1_0_0_8_100_100_100_100_
100_100(80)(68)
Received ..... !A(53)(151)
```

5.4.4 Command: C

Command Type Query/Update
 Description Query or update System 2 parameters.
 Available parameters include Minimum Frequency, Maximum Frequency, Minimum Rate, Maximum Rate, Minimum Thickness, Maximum Thickness, and Etch Mode.

Command Structure

```
Query ..... C?
Update ..... C_<Min Frequency>_<Max Frequency>_
<Min Rate>_<Max Rate>_<Min Thickness>_
<Max Thickness>_ <Etch Mode>
```

Parameters

```
Min Frequency ..... 1.000 to 6.400 (MHz)
Max Frequency ..... 1.100 to 6.500 (MHz)
Min Rate ..... -99 to 999 (Å/s)
Max Rate ..... -99 to 999 (Å/s)
Min Thickness ..... 0.000 to 9999 (kÅ)
Max Thickness ..... 0.000 to 9999 (kÅ)
Etch Mode ..... 0 or 1. 0 indicates Etch Mode is OFF. 1
indicates Etch Mode is ON.
```

Example (query)

```
Sent ..... !C?(103)(47)
Received ..... !LA_4.000_6.000_0.000_100.000_0.000_
1.000_0(86)(120)
```

Example (update)

```
Sent ..... !IC_5.000_6.000_0.000_10.00_0.000_
10.00_0(146)(41)
Received ..... !A(53)(151)
```

5.4.8 Command: M

Command Type Status
 Description Read the current Average Rate.
 Command Structure M
 Parameters None
 Example
 Sent !#M(142)(138)
 Received !*A_0.00_(91)(100)

5.4.9 Command: N

Command Type Status
 Description Read the current Thickness for a sensor.
 Command Structure N<Sensor number>
 Parameters
 Sensor Number 1 to 6
 Example
 Sent !\$N1(93)(81)
 Received !+A_0.000_(74)(111)

5.4.10 Command: O

Command Type Status
 Description Read the current Average Thickness.
 Command Structure O
 Parameters None
 Example
 Sent !#O(143)(57)
 Received !+A_0.000_(74)(111)

5.4.11 Command: P

Command Type Status
 Description Read the current Frequency for a sensor.
 Command Structure P<Sensor number>
 Parameters
 Sensor number 1 to 6
 Example
 Sent !\$P1(90)(145)
 Received. !/A5500110.056(147)(45)

5.4.12 Command: R

Command Type Status
 Description Read the Crystal Life for a sensor.
 Command Structure R<Sensor number>
 Parameters
 Sensor number 1 to 6
 Example
 Sent !\$R1(105)(114)
 Received. !*A_50.01(134)(76)

5.4.13 Command: S

Command Type Remote
 Description Zero Average Thickness and Rate. This also sets all active Sensor Rates and Thicknesses to zero.
 Command Structure S
 Parameters None
 Example
 Sent !#S(142)(143)
 Received. !\$A(53)(151)

PN 074-511-P1E

5.4.14 Command: T

Command Type Remote
 Description Zero Time
 Command Structure T
 Parameters None
 Example
 Sent !#T(79)(53)
 Received !\$A(53)(151)

5.4.15 Command: U

Command Type Status/Remote
 Description Open/close the Source Shutter or read the Source Shutter state.
 Command Structure
 Query U?
 Remote U<Shutter Status>
 Parameters
 Shutter Status 0 or 1. 0 closes the shutter. 1 opens the shutter.
 Example (Status)
 Sent !\$U?(91)(84)
 Received !%A0(118)(135)
 Example (Remote Open Shutter)
 Sent !\$U1(90)(113)
 Received !\$A(53)(151)

5.4.16 Command: W

Command Type Status
 Description Read the Rate (Å/s), Thickness (Å), and Frequency (Hz) for each sensor simultaneously.
 Command Structure W
 Parameters None

Example

```
Sent ..... !#W(143)(53)
Received..... !xC4A00.00_07.10_3076.190_
5497894.642_07.10_3076.190_
5498079.900_00.00_00.000_5500330.115_
00.00_00.000_5500440.030_00.00_
00.000_5500550.070_00.00_00.000_
5500660.115_(38)(71)
```

NOTE: Ignore the first 00.00 in the response.

5.4.17 Command: Y

Command Type Status

Description Read the status of the Power-Up Reset flag. The Power-Up Reset flag is set while SQM-160 turns on, and stays set until the status of the RS-232 interface is read. After the flag is read, it is reset and will not be set again until SQM-160 is power cycled.

Command Structure Y

Parameters None. In the response, 0 indicates the Power-Up Reset flag has been RESET. 1 indicates the Power-Up Reset flag is SET.

Example

```
Sent ..... !#Y(142)(144)
Received..... !%A1(55)(60)
!%A0(118)(135)
```

5.4.18 Command: Z

Command Type Update

Description Default all film and system parameters.

Command Structure Z

Parameters None

Example

```
Sent ..... !#Z(78)(144)
Received..... !$A(53)(151)
```

5.5 CRC Examples

This section includes examples of code for calculating the CRC in Visual Basic, Java, and C++. Instructions for calculating the CRC are located in [section 5.3.3 on page 5-11](#).

5.5.1 Visual Basic® 5/6

```
Public Sub CalcChkSumByte(ByRef ByData() As Byte, ByRef byCRC() As
Byte)

    Dim CRC As Integer
    Dim TmpCRC As Integer
    Dim LastIndex As Long
    Dim i As Integer
    Dim j As Integer

    LastIndex = UBound(ByData())

    ' Avoid on length messages
    If ByData(1) > 0 Then
        ' Set 14 bit CRC to all ones
        CRC = &H3FFF
        For j = 1 To LastIndex - 2
            ' XOR current character with CRC
            CRC = CRC Xor ByData(j)
            ' Go thru lower 8 bits of CRC
            For i = 1 To 8
                ' Save CRC before shift
                TmpCRC = CRC
                ' Shift right one bit
                CRC = Shri(CRC, 1)
                If (TmpCRC And 1) = 1 Then
                    ' If LSB is 0 (before shift), XOR with hex 2001
                    CRC = CRC Xor &H2001
                End If
            Next i
        Next j
        ' Be sure we still have 14 bits
        CRC = CRC And &H3FFF
        byCRC(0) = (LoByte(CRC) And &H7F) + 34
        byCRC(1) = (LoByte(Shri(CRC, 7)) And &H7F) + 34
    Else
        ' Empty message
        byCRC(0) = 0
        byCRC(1) = 0
    End If
End Sub
```

```

Public Function LoByte(ByVal intNumber As Integer) As Byte
    ' Comments : Returns the low byte of the passed integer
    ' Parameters: intNumber - integer value for which to return the low
byte
    ' Returns : byte
    ' Source : Total VB SourceBook 6
    '
    On Error GoTo PROC_ERR

    LoByte = intNumber And &HFF&

PROC_EXIT:
    Exit Function

PROC_ERR:
    MsgBox "Error: " & Err.Number & ". " & Err.Description, , _
        "LoByte"
    Resume PROC_EXIT

End Function

Public Function Shri( _
    ByVal lngValue As Long, _
    ByVal bytPlaces As Byte) _
    As Integer
    ' Comments : Shifts a long Value right the selected number of places
    ' Parameters: lngValue - integer Value to shift
    '             bytPlaces - number of places to shift
    ' Returns : Shifted value
    ' Source : Total VB SourceBook 6
    '
    Dim lngDivisor As Long

    On Error GoTo PROC_ERR

    ' if we are shifting 16 or more bits, then the result is always
zero
    If bytPlaces >= 16 Then
        Shri = 0
    Else
        lngDivisor = 2 ^ bytPlaces
        Shri = Int(IntToLong(lngValue) / lngDivisor)
    End If

PROC_EXIT:
    Exit Function

```

```
PROC_ERR:
    MsgBox "Error: " & Err.Number & ". " & Err.Description, , _
        "Shri"
    Resume PROC_EXIT
```

End Function

5.5.2 Java®

```
private short calcCRC(byte[] str) {
    short crc = 0;
    short tmpCRC;
    int length = 1 + str[1] - 34;
    if (length > 0) {

        crc = (short) 0x3fff;
        for (int jx = 1; jx <= length; jx++) {
            crc = (short) (crc ^ (short) str[jx]);

            for (int ix = 0; ix < 8; ix++) {
                tmpCRC = crc;
                crc = (short) (crc >> 1);
                if ((tmpCRC & 0x1) == 1) {
                    crc = (short) (crc ^ 0x2001);
                }
            }
            crc = (short) (crc & 0x3fff);
        }
    }
    return crc;
}

private byte crcHigh(short crc) {
    byte val = (byte) (((crc >> 7) & 0x7f) + 34);
    return val;
}

private byte crcLow(short crc) {
    byte val = (byte) ((crc & 0x7f) + 34);
    return val;
}
}
```

5.5.3 C++

```
class CRC14
{
public:
    CRC14(void) { crc = 0x0;};

public:
    short crc;

public:
    short calcCRC( unsigned char * str)
    {
        int length = (str != NULL) ? 1 + str[1] - 34 : 0;

        if (length > 0) {

            crc = (short) 0x3fff;
            for (int jx = 1; jx <= length; jx++) {
                crc = (short) (crc ^ (short) str[jx]);

                for (int ix = 0; ix < 8; ix++) {
                    short tmpCRC = crc;
                    crc = (short) (crc >> 1);
                    if ((tmpCRC & 0x1) == 1) {
                        crc = (short) (crc ^ 0x2001);
                    }
                }
                crc = (short) (crc & 0x3fff);
            }
        }
        return crc;
    }

    unsigned char crc2() {
        unsigned char val = (unsigned char) (((crc >> 7) & 0x7f) +
34);
        return val;
    }

    unsigned char crc1() {
        unsigned char val = (unsigned char) ((crc & 0x7f) + 34);
        return val;
    }
};
```

This page is intentionally blank.

Chapter 6

Troubleshooting and Maintenance

6.1 Troubleshooting Guide

If SQM-160 does not function as expected, or appears to have diminished performance, the following Symptom/Cause/Remedy chart may be helpful (see [Table 6-1](#)). Additional troubleshooting information can be found in the operating manuals for sensors, located on the Thin Film Instrument and Sensor Manuals CD. If the problem cannot be resolved, contact INFICON (refer to [section 1.3, How To Contact INFICON, on page 1-4](#)).



CAUTION

There are no user-serviceable components within the SQM-160 case.

Refer all maintenance to qualified personnel.

Table 6-1 Symptom/Cause/Remedy chart

SYMPTOM	CAUSE	REMEDY
SQM-160 does not turn on.	Power cable is not plugged into SQM-160 or rear panel power switch is not on.	Connect power cable. Set the rear panel power switch to position 1 (ON).
	Incorrect line voltage.	Line voltage must be within SQM-160 line voltage specification (refer to section 1.4.5 on page 1-7).
	Fuse open.	Remove the fuse drawer from the power inlet and examine both fuses, or use an ohmmeter to check the fuses. Replace open fuses with the specified fuse (refer to section 1.4.5 on page 1-7).
	SQM-160 is malfunctioning.	Contact INFICON service department (refer to section 1.3 on page 1-4).
SQM-160 “locks up.”	Covers/panels not installed or not secured.	Install and securely fasten all covers and panels.

Table 6-1 Symptom/Cause/Remedy chart (continued)

SYMPTOM	CAUSE	REMEDY
SQM-160 “locks up.”	Electrical noise is being picked up by cables connected to SQM-160.	Locate the sensor, oscillator cables, I/O cables, and power cable at least 30.5 cm (1 ft.) away from high voltage / high power cables and other sources of electrical noise.
	Inadequate system grounding.	Ground wires or straps should be short with large surface area to minimize impedance to ground. Ground wires or straps must connect to an appropriate earth ground (refer to section 2.1 on page 2-1).
	SQM-160 is malfunctioning.	Contact INFICON service department (refer to section 1.3 on page 1-4).
Stored parameter values are lost when SQM-160 is turned on.	SQM-160 is malfunctioning.	Contact INFICON service department. (refer to section 1.3 on page 1-4).
Thickness, Frequency, or Mass reading is unstable or drifting (not the frequency decrease or Thickness/Mass increase associated with material being deposited on the crystal).	Temperature of the crystal is unstable (an AT-cut crystal may drift as much as 10 Hz/°C).	Control the vacuum chamber temperature. Move the crystal farther away from the source (at least 25.4 cm (10 in.) from source). Check sensor water cooling for correct flow and temperature. Refer to the sensor operating manual. Clean or replace the crystal holder. Refer to the sensor operating manual for cleaning instructions. Use SPC-1157-G10 thermal shock crystals designed to minimize frequency shifts due to heat load.

PN 074-511-P1E

Table 6-1 Symptom/Cause/Remedy chart (continued)

SYMPTOM	CAUSE	REMEDY
<p>Thickness, Frequency, or Mass reading is unstable or drifting (not the frequency decrease or Thickness/Mass increase associated with material being deposited on the crystal).</p>	<p>Humidity level on the crystal is changing. Moisture being absorbed or exuded from the crystal surface.</p>	<p>Avoid condensation by turning off cooling water to sensor before opening the vacuum chamber to air, and then flow heated water above the room dew point through the sensor when the chamber is open.</p>
	<p>Crystal or crystal holder crystal seating surface scratched or dirty.</p>	<p>Replace crystal. Clean the crystal seating surface inside the crystal holder or replace crystal holder. Refer to sensor operating manual for cleaning instructions.</p>
	<p>Bad sensor/feedthrough, or bad in-vacuum cable, or bad BNC cable.</p>	<p>Use an ohmmeter to check electrical continuity and isolation of sensor/feedthrough, in-vacuum cable, and both BNC cables. Refer to the sensor operating manual for detailed troubleshooting information.</p>
	<p>Excessive cable length between oscillator and crystal.</p>	<p>In-vacuum cable length should not exceed 78.1 cm (30.75 in.). Use the 15.2 cm (6 in.) cable between oscillator and feedthrough.</p>

PN 074-511-P1E

Table 6-1 Symptom/Cause/Remedy chart (continued)

SYMPTOM	CAUSE	REMEDY
<p>Thickness, Frequency, or Mass reading is unstable or drifting (not the frequency decrease or Thickness/Mass increase associated with material being deposited on the crystal).</p>	<p>SQM-160 or oscillator is malfunctioning.</p>	<p>Test the SQM-160 and oscillator using the oscillator test mode (see section 6.4 on page 6-13).</p> <p>Substitute a known good SQM-160 (or other QCM).</p> <p>Substitute a known good oscillator.</p> <p>Substitute a PN 760-601-G2 Sensor Emulator or a known good sensor for the sensor.</p>
<p>Thickness, Frequency, or Mass reading deviates greatly from the expected value.</p>	<p>Excessive cable length between oscillator and crystal is causing self-oscillation at a frequency different than the crystal frequency.</p>	<p>In-vacuum cable length should not exceed 78.1 cm (30.75 in.).</p> <p>Use the 15.2 cm (6 in.) cable between oscillator and feedthrough.</p>
	<p>Bad sensor/feedthrough, or bad in-vacuum cable, or bad BNC cable.</p>	<p>Use an ohmmeter to check electrical continuity and isolation of sensor/feedthrough, in-vacuum cable, and both BNC cables. Refer to the sensor operating manual for detailed troubleshooting information.</p>
	<p>SQM-160 or oscillator is malfunctioning.</p>	<p>Test the SQM-160 and oscillator using the oscillator test mode (see section 6.4 on page 6-13).</p> <p>Substitute a known good SQM-160 (or other QCM).</p> <p>Substitute a known good oscillator.</p> <p>Substitute a PN 760-601-G2 Sensor Emulator or a known good sensor for the sensor.</p>

PN 074-511-P1E

Table 6-1 Symptom/Cause/Remedy chart (continued)

SYMPTOM	CAUSE	REMEDY
Crystal Status indicator is blinking, indicating Xtal fail.	Failed crystal, or no crystal in sensor.	Install a new crystal.
	Two crystals were installed or crystal is upside down.	Remove extra crystal. Reverse crystal orientation. Inspect crystal for scratches; if scratched, replace with new crystal.
	Built-up material at crystal holder aperture is touching the crystal.	Clean or replace the crystal holder. Refer to the sensor operating manual for cleaning instructions.
	Crystal frequency is not within the frequency range of SQM-160.	Use a crystal with starting frequency appropriate for SQM-160 frequency range. Change the FMin/Max frequency settings in SQM-160.
	Oscillator/sensor not connected to the Sensor channel corresponding to the blinking Crystal Status indicator.	Connect oscillator/sensor to all active Sensor channels.
	Excessive cable length between oscillator and crystal.	In-vacuum cable length should not exceed 78.1 cm (30.75 in.). Use the 15.2 cm (6 in.) cable between oscillator and feedthrough.

PN 074-511-P1E

Table 6-1 Symptom/Cause/Remedy chart (continued)

SYMPTOM	CAUSE	REMEDY
<p>Crystal Status indicator is blinking, indicating Xtal fail.</p>	<p>Bad sensor/feedthrough, or bad in-vacuum cable, or bad BNC cable.</p>	<p>Use an ohmmeter to check electrical continuity and isolation of sensor/feedthrough, in-vacuum cable, and both BNC cables. Refer to the sensor operating manual for detailed troubleshooting information.</p> <p>Substitute known good BNC cables.</p> <p>Substitute a known good in-vacuum cable.</p> <p>Substitute a known good sensor/feedthrough.</p> <p>Substitute a PN 760-601-G2 Sensor Emulator for the sensor.</p>
	<p>SQM-160 or oscillator is malfunctioning.</p>	<p>Test the SQM-160 and oscillator using the oscillator test mode (see section 6.4 on page 6-13).</p> <p>Substitute a known good SQM-160 (or other QCM).</p> <p>Substitute a known good oscillator.</p> <p>Substitute a PN 760-601-G2 Sensor Emulator for the sensor.</p>

PN 074-511-P1E

Table 6-1 Symptom/Cause/Remedy chart (continued)

SYMPTOM	CAUSE	REMEDY
Crystal Status indicator is blinking, indicating Xtal fail, during deposition before “normal” life of crystal is exceeded.	Crystal is being hit by small droplets of molten material from the evaporation source.	Use a shutter to shield the sensor during source conditioning. Move the crystal farther away (at least 25.4 cm (10 in.)) from the source.
	Damaged crystal or deposited material is causing stress to crystal.	Replace the crystal. Use an Alloy crystal if appropriate for deposited material.
	Material buildup on crystal holder is partially masking the crystal surface.	Clean or replace the crystal holder. Refer to the sensor operating manual for cleaning instructions.
	Shutter is partially obstructing deposition flux or sensor is poorly positioned, causing uneven distribution of material on crystal.	Visually check crystal for an uneven coating, and if present, correct shutter or sensor positioning problem.
	Crystal oscillation is weak due to excessive cable length between oscillator and crystal.	In-vacuum cable length should not exceed 78.1 cm (30.75 in.). Use the 15.2 cm (6 in.) cable between oscillator and feedthrough.
Crystal Status indicator is blinking, indicating Xtal fail, when vacuum chamber is opened to air.	Crystal was near the end of its life; opening to air causes film oxidation, which increases film stress.	Replace the crystal.
	Excessive moisture accumulation on the crystal.	Avoid condensation by turning off cooling water to sensor before opening the vacuum chamber to air, and then flow heated water above the room dew point through the sensor when the chamber is open.

PN 074-511-P1E

Table 6-1 Symptom/Cause/Remedy chart (continued)

SYMPTOM	CAUSE	REMEDY
<p>Rate reading, and Thickness, Frequency, or Mass reading are noisy.</p>	<p>Excessive cable length between oscillator and crystal.</p>	<p>In-vacuum cable length should not exceed 78.1 cm (30.75 in.).</p> <p>Use the 15.2 cm (6 in.) cable between oscillator and feedthrough.</p>
	<p>Electrical noise is being picked up by cables connected to SQM-160.</p>	<p>Locate the sensor, oscillator cables, I/O cables, communications cable, and power cable at least 30.5 cm (1 ft.) away from high voltage / high power cables and other sources of electrical noise.</p>
	<p>Inadequate system grounding.</p>	<p>Ground wires or straps should be short with large surface area to minimize impedance to ground.</p> <p>Ground wires or straps should connect to an appropriate earth ground (refer to section 2.1 on page 2-1).</p>

Table 6-1 Symptom/Cause/Remedy chart (continued)

SYMPTOM	CAUSE	REMEDY
Thickness, Frequency, or Mass reading has large excursions during deposition.	Mode hopping due to damaged crystal.	Replace the crystal.
	Crystal is near the end of its life.	Replace the crystal.
	Scratches or foreign particles on the crystal holder crystal seating surface.	Clean the crystal seating surface inside the crystal holder or replace crystal holder. Refer to sensor operating manual for cleaning instructions.
	Uneven coating onto crystal.	A straight line from center of source to center of crystal should be perpendicular to face of crystal.
	Particles on crystal.	Replace crystal. Remove source of particles.
	Intermittent cables or connections.	Use an ohmmeter to check electrical continuity / isolation of sensor head, feedthrough, in-vacuum cable, and BNC cables. Refer to the sensor operating manual for detailed troubleshooting information.
	Inadequate cooling of crystal.	Check water flow rate and temperature for sensor cooling.
Thickness, Frequency, or Mass reading has large excursions during source warm-up or when source shutter is opened (usually causes Thickness reading to decrease) and after the termination of deposition (usually causes Thickness reading to increase).	Crystal not properly seated or crystal holder crystal seating surface is dirty.	Check crystal installation. Clean the crystal seating surface inside the crystal holder or replace crystal holder. Refer to sensor operating manual for cleaning instructions.

PN 074-511-P1E

Table 6-1 Symptom/Cause/Remedy chart (continued)

SYMPTOM	CAUSE	REMEDY
<p>Thickness, Frequency, or Mass reading has large excursions during source warm-up or when source shutter is opened (usually causes Thickness reading to decrease) and after the termination of deposition (usually causes Thickness reading to increase).</p>	<p>Excessive heat input to the crystal.</p>	<p>If heat is due to radiation from the evaporation source, move sensor farther away (at least 25.4 cm (10 in.)) from source.</p> <p>Use SPC-1157-G10 thermal shock crystals designed to minimize frequency shifts due to heat load.</p>
	<p>Inadequate cooling of crystal.</p>	<p>Check water flow rate and temperature for sensor cooling.</p>
	<p>Crystal is being heated by electron flux.</p>	<p>Use a sputtering sensor for non-magnetron sputtering.</p>
	<p>Crystal is being hit by small droplets of molten material from the evaporation source.</p>	<p>Use a shutter to shield the sensor during source conditioning.</p> <p>Move the crystal farther away (at least 25.4 cm (10 in.)) from the source.</p>
	<p>Intermittent connection occurring in sensor or feedthrough with thermal variation.</p>	<p>Use an ohmmeter to check electrical continuity / isolation of sensor head, feedthrough, and in-vacuum cable. Refer to the sensor operating manual for detailed troubleshooting information.</p>

Table 6-1 Symptom/Cause/Remedy chart (continued)

SYMPTOM	CAUSE	REMEDY
Thickness reproducibility is poor.	Erratic evaporation flux characteristics.	Move sensor to a different location. Check the evaporation source for proper operating conditions. Ensure relatively constant pool height and avoid tunneling into the melt. Assign multiple sensors to the source.
	Material does not adhere well to the crystal.	Check for contamination on the crystal surface. Evaporate an intermediate layer of appropriate material onto the crystal to improve adhesion. Use gold, silver, or alloy crystals, as appropriate.
SQM-160 Comm software does not install correctly or does not function correctly.	Host computer has incompatible operating system or incompatible version of operating system.	Check that operating system and version are compatible with SQM-160 Comm software (refer to Chapter 4).
Communication cannot be established between the host computer and SQM-160.	Communications cable is not connected properly to SQM-160 or host computer.	Check cable connections.
	Baud setting in SQM-160 is different than the baud setting in SQM-160 Comm software, or the wrong comm port is selected in SQM-160 Comm software.	Correct communications port settings (refer to section 3.5 on page 3-6 and section 4.8 on page 4-17).
	SQM-160 Comm software version is not compatible with SQM-160 firmware version.	Contact INFICON technical support (refer to section 1.3 on page 1-4).
RS-232 communication issue.	RS-232 cable is not the correct type.	Use straight-through RS-232 cable (refer to section 5.1.1 on page 5-1).

PN 074-511-P1E

Table 6-1 Symptom/Cause/Remedy chart (continued)

SYMPTOM	CAUSE	REMEDY
USB communication issue.	USB device driver is not installed correctly.	Refer to section 5.1.2 on page 5-2 .
Ethernet communication issue.	Ethernet network settings in host computer are incorrect.	Refer to section 5.1.3 on page 5-2 .
	Ethernet IP address setting in SQM-160 Comm software does not match IP address of SQM-160 Ethernet module.	Change Ethernet module IP address or SQM-160 Comm software IP address (refer to section 5.1.3.2 on page 5-8).
	Straight-through Ethernet cable is not auto-detected by an older host computer.	Use a cross-over Ethernet cable for a direct connection to a host computer that does not auto-detect cable type.

6.2 Maintenance

Routine maintenance is not required for SQM-160. Regular sensor maintenance procedures should be followed according to the sensor operating manual.

6.3 Spare Parts

Fuse	PN 062-0105
Oscillator	PN 783-500-013
BNC Cable (15.2 cm (6 in.))	PN 782-902-011
BNC Cable (3.0 m (10 ft.))	PN 782-902-012-10
BNC Cable (7.6 m (25 ft.))	PN 782-902-012-25
BNC Cable (15.2 m (50 ft.))	PN 782-902-012-50
BNC Cable (22.8 m (75 ft.))	PN 782-902-012-75

6.4 Persistent Crystal Fail Indication

OSC-100 oscillators have a test feature to help isolate persistent crystal fail problems (see [Figure 6-1](#)). To activate the test feature, press the **Push to Test** button using a small, pointed object, such as a pen or a small screwdriver. This connects the internal test crystal to the circuit instead of the normal **Sensor** connector. If SQM-160 and the oscillator are functioning correctly, the Crystal Status indicator will stop blinking and illuminate while this button is depressed. Once the **Push to Test** button is released, the oscillator returns to normal operation and the internal test crystal is no longer in use.

If Crystal Status indicator stops blinking and illuminates while the **Push to Test** button is depressed, the problem has been isolated to be in the path between the oscillator and the sensor head. If the Crystal Status indicator continues to blink while the **Push to Test** button is depressed, the problem is either the programming of the sensor selection, in the electronics of the oscillator, or SQM-160.

Figure 6-1 OSC-100 oscillator



This page is intentionally blank.

Chapter 7

Calibration Procedures

7.1 Importance of Density, Tooling and Z-Ratio

The quartz crystal microbalance is capable of precisely measuring the mass added to the face of the oscillating quartz crystal sensor. SQM-160 recognizes the density of this added material to allow conversion of the mass information into thickness. In some instances, where highest accuracy is required, it is necessary to make a density calibration (see [section 7.2](#)).

Because the flow of material from a deposition is not uniform, it is necessary to account for the different amount of material flow onto the sensor, compared to the substrates. This is accounted for by the Tooling parameter. Tooling can be experimentally established by following the guidelines in [section 7.3 on page 7-2](#).

If the Z-Ratio is not known, it could be estimated from the procedures, outlined in [section 7.4 on page 7-3](#).

7.2 Determining Density

NOTE: The bulk density values retrieved from [Appendix A](#) are sufficiently accurate for most applications.

To determine Density value:

- 1 Place a substrate (with proper masking for film thickness measurement) adjacent to the sensor, to ensure the same thickness will be accumulated on the crystal and substrate.
- 2 Set Density to the bulk value of the Film material or to an approximate value.
- 3 Set Z-Ratio to 1.000 and Tooling to 100%.
- 4 Place a new crystal in the sensor and make a short deposition (1000 to 5000 Å).
- 5 After deposition, remove the test substrate and measure the Film thickness with either a multiple beam interferometer or a stylus-type profilometer.

- 6 Determine the new Density value with [equation \[1\]](#):

$$\text{Density}(\text{g}/\text{cm}^3) = D_1 \left(\frac{T_x}{T_m} \right) \quad [1]$$

where:

D_1 = Initial Density setting

T_x = Thickness reading on SQM-160

T_m = Measured thickness

- 7 A quick check of the calculated Density may be made. If the SQM-160 thickness has not been zeroed between the test deposition, enter the calculated Density. Program SQM-160 with the new Density value and observe whether the displayed thickness is equal to the measured thickness.

NOTE: Due to variations in source distribution and other system factors, it is recommended that a minimum of three separate evaporations be made, to obtain an average value for Density.

NOTE: Slight adjustment of Density may be necessary, in order to achieve $T_x = T_m$.

7.3 Determining Tooling

- 1 Place a test substrate in the system substrate holder.
- 2 Make a short deposition and determine actual thickness.
- 3 Calculate Tooling from the relationship in [equation \[2\]](#):

$$\text{Tooling} (\%) = \text{TF}_i \left(\frac{T_m}{T_x} \right) \quad [2]$$

where

T_m = Actual thickness at substrate holder

T_x = Thickness reading in SQM-160

TF_i = Initial Tooling factor

- 4 Round percent tooling to the nearest 1%.
- 5 When entering this new value for Tooling into the program, if calculations are done properly, T_m will equal T_x .

NOTE: To account for variations in source distribution and other system factors, obtain an average value for Tooling, using a minimum of three separate evaporations.

7.4 Laboratory Determination of Z-Ratio

A list of Z-Ratio values for materials commonly used are available in [Appendix A](#). For other materials, Z-Ratio can be calculated from the following formula:

$$Z = \left(\frac{d_q \mu_q}{d_f \mu_f} \right)^{\frac{1}{2}} \quad [3]$$

$$Z = 9.378 \times 10^5 (d_f \mu_f)^{-\frac{1}{2}} \quad [4]$$

where:

d_f = Density (g/cm³) of deposited film

μ_f = Shear modulus (dynes/cm²) of deposited film

d_q = Density of quartz (crystal) (2.649 g/cm³)

μ_q = Shear modulus of quartz (crystal) (3.32 x 10¹¹ dynes/cm²)

NOTE: The densities and shear moduli of many materials can be found in a number of handbooks.

Laboratory results indicate that Z-Ratio of materials in thin-film form are very close to the bulk values; however, for high stress producing materials, Z-Ratio values of thin films are slightly smaller than those of the bulk materials. For applications that require more precise calibration, the following direct method is suggested:

- 1 Establish the correct density value as described in [section 7.2 on page 7-1](#).
- 2 Install a new crystal and record its starting Frequency, F_{co} .
- 3 Make a deposition on a test substrate such that the percent Crystal Life display will read approximately 50%, or near the end of crystal life for the particular material, whichever is smaller.
- 4 Stop the deposition and record the ending crystal Frequency F_c .
- 5 Remove the test substrate and measure the film thickness with either a multiple beam interferometer or a stylus-type profilometer.

- 6** Using the Density value from step 1 and the recorded values for F_{co} and F_c , adjust the Z-Ratio value in thickness equation [5] to bring the calculated thickness value into agreement with the actual thickness.
- ◆ If the calculated value of thickness is greater than the actual thickness, increase the Z-Ratio value.
 - ◆ If the calculated value of thickness is less than the actual thickness, decrease the Z-Ratio value.

$$T_f = \frac{Z_q \times 10^4}{2\pi zp} \left\{ \left(\frac{1}{F_{co}} \right) \text{ATan} \left(z \text{Tan} \left(\frac{\pi F_{co}}{F_q} \right) \right) - \left(\frac{1}{F_c} \right) \text{ATan} \left(z \text{Tan} \left(\frac{\pi F_c}{F_q} \right) \right) \right\} \quad [5]$$

where:

T_f = Thickness of deposited film (kÅ)

F_{co} = Starting frequency of the sensor crystal (Hz)

F_c = Final frequency of the sensor crystal (Hz)

F_q = Nominal blank frequency = 6045000 (Hz)

z = Z-Ratio of deposited film material

Z_q = Specific acoustic impedance of quartz = 8765000 (kg/(m²*s))

p = Density of deposited film (g/cm³)

For multiple layer deposition (for example, two layers), the Z-Ratio used for the second layer is determined by the relative thickness of the two layers. For most applications, the following three rules will provide reasonable accuracies:

- ◆ If the thickness of layer 1 is large compared to layer 2, use material 1 Z-Ratio for both layers.
- ◆ If the thickness of layer 1 is thin compared to layer 2, use material 2 Z-Ratio for both layers.
- ◆ If the thickness of both layers is similar, use a value for Z-Ratio which is the weighted average of the two Z-Ratio values for deposition of layer 2 and subsequent layers.

Chapter 8

Measurement and Theory

8.1 Basics

The Quartz Crystal deposition Monitor (QCM) utilizes the piezoelectric sensitivity of a quartz monitor crystal to added mass. The QCM uses this mass sensitivity to control the deposition rate and final thickness of a vacuum deposition.

When a voltage is applied across the faces of a properly shaped piezoelectric crystal, the crystal is distorted and changes shape in proportion to the applied voltage. At certain discrete frequencies of applied voltage, a condition of sharp electro-mechanical resonance is encountered.

When mass is added to the face of a resonating quartz crystal, the frequency of these resonances are reduced. This change in frequency is very repeatable and is precisely understood for specific oscillating modes of quartz. This phenomenon is the basis of an indispensable measurement and process control tool that can easily detect the addition of less than an atomic layer of an adhered foreign material.

In the late 1950's it was noted by Sauerbrey^{1,2} and Lostis³ that the change in frequency, $DF = F_q - F_c$, of a quartz crystal with coated (or composite) and uncoated frequencies, F_c and F_q respectively, is related to the change in mass from the added material, M_f , as follows:

$$\frac{M_f}{M_q} = \frac{(\Delta F)}{F_q} \quad [1]$$

where M_q is the mass of the uncoated quartz crystal. Simple substitutions lead to the equation used with the first frequency measurement instruments:

$$T_f = \frac{K(\Delta F)}{d_f} \quad [2]$$

where the film thickness, T_f , is proportional (through K) to the frequency change, DF , and inversely proportional to the density of the film, d_f . The constant, $K = N_{at}d_q/F_q^2$; where d_q ($= 2.649 \text{ g/cm}^3$) is the density of single crystal quartz and N_{at} ($= 166100 \text{ Hz cm}$) is the frequency constant of AT cut quartz.

1.G. Z. Sauerbrey, Phys. Verhand .8, 193 (1957)
 2.G. Z. Sauerbrey, Z. Phys. 155,206 (1959)
 3.P. Lostis, Rev. Opt. 38,1 (1959)

A crystal with a starting frequency of 6.0 MHz will display a reduction of its frequency by 2.27 Hz when 1 angstrom of Aluminum (density of 2.77 g/cm^3) is added to its surface. In this manner, the thickness of a rigid adlayer is inferred from the precise measurement of the frequency shift of the crystal.

The quantitative knowledge of this effect provides a means of determining how much material is being deposited on a substrate in a vacuum system, a measurement that was not convenient or practical prior to this understanding.

8.1.1 Monitor Crystals

No matter how sophisticated the electronics surrounding it, the essential device of the deposition monitor is the quartz crystal. The quartz crystal in [Figure 8-1](#) has a frequency response spectrum that is schematically displayed in [Figure 8-2](#). The ordinate represents the magnitude of response, or current flow of the crystal, at the specified frequency.

Figure 8-1 Quartz resonator

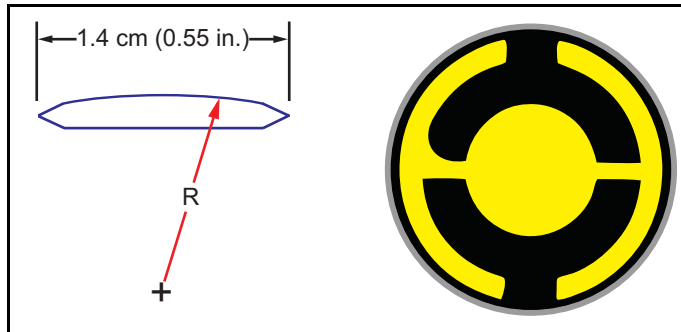

The lowest frequency response is primarily a thickness shear mode that is called the **fundamental**. The characteristic movement of the thickness shear mode is for displacement to take place parallel to the major monitor crystal faces. In other words, the faces are displacement antinodes (see [Figure 8-3](#)).

The responses located slightly higher in frequency are called **anharmonics**; they are a combination of the thickness shear and thickness twist modes. The response at about three times the frequency of the fundamental is called the **third quasiharmonic**. There are also a series of anharmonics slightly higher in frequency associated with the quasiharmonic.

The monitor crystal design depicted in [Figure 8-1](#) is the result of several significant improvements from the square crystals, with fully electroded plane parallel faces that were first used.

The first improvement implemented the use of circular crystals. The resulting increase in symmetry greatly reduces the number of allowed vibrational modes.

The second set of improvements was to contour one face of the crystal and to reduce the size of the exciting electrode. These improvements have the effect of trapping the acoustic energy.

Reducing the electrode diameter limits the excitation to the central area. Contouring dissipates the energy of the traveling acoustic wave before it reaches the edge of the crystal. Energy is not reflected back to the center where it can interfere with other newly launched waves, essentially making a small crystal appear to behave as though it is infinite in extent.

With the crystal vibrations restricted to the center, it is practical to clamp the outer edges of the crystal to a holder, and not produce any undesirable effects. Contouring also reduces the intensity of response of the generally unwanted anharmonic modes; hence, the potential for an oscillator to sustain an unwanted oscillation is substantially reduced.

Figure 8-2 Frequency response spectrum

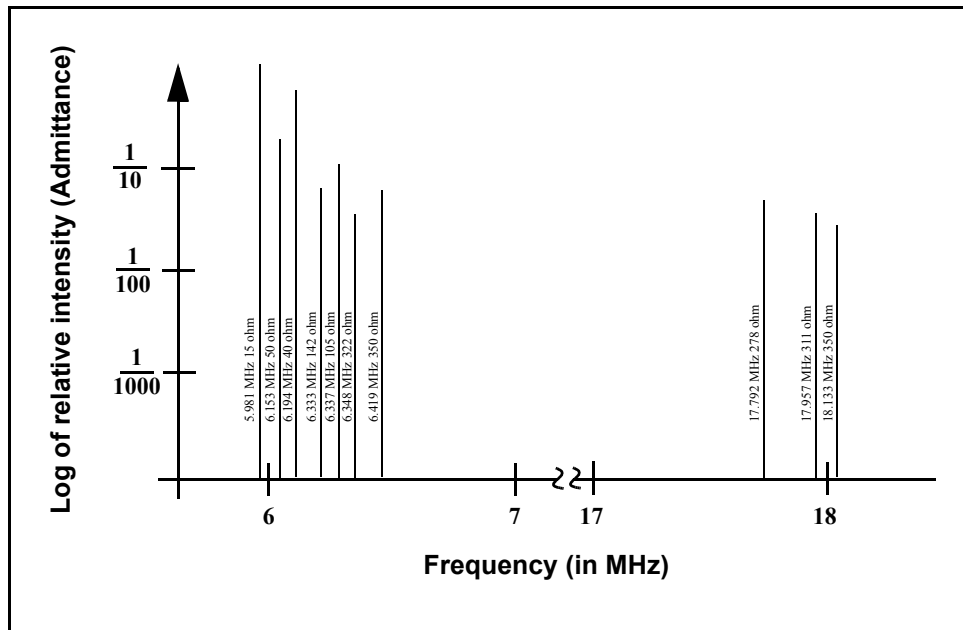

The use of an adhesion layer has improved the electrode-to-quartz bonding, reducing rate spikes caused by micro-tears between the electrode and the quartz, as film stress rises. These micro-tears leave portions of the deposited film unattached, and therefore unable to participate in the oscillation. These free portions are no longer detected, which prevents the consequential wrong thickness from being inferred.

The AT resonator is usually chosen for deposition monitoring, because at room temperature it can be made to exhibit a very small frequency change, due to temperature changes.

Since there is currently no way to separate the frequency change caused by added mass (which is negative), or even the frequency changes caused by temperature gradients across the crystal or film induced stresses, it is essential to minimize these temperature-induced changes. It is only in this way that small changes in mass can be measured accurately.

Figure 8-3 Thickness shear displacement

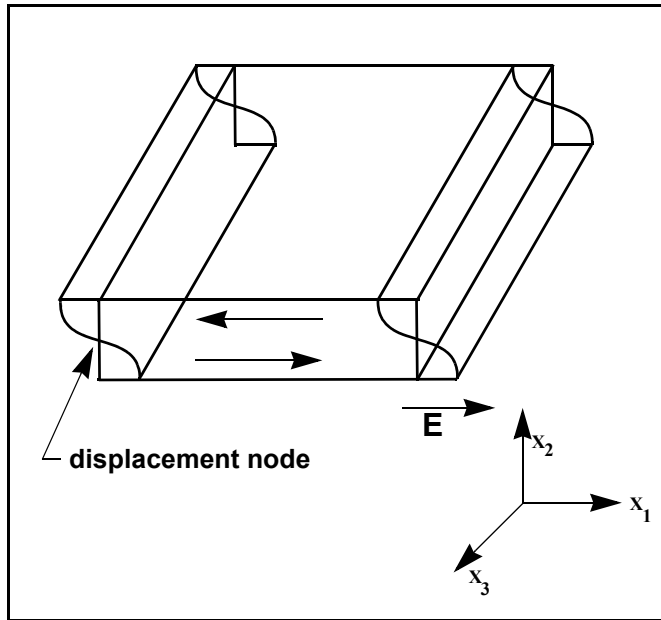

8.1.2 Period Measurement Technique

Although instruments using equation [2] were very useful, it was soon noted that they had a limited range of accuracy, typically holding accuracy for DF less than $0.02 F_q$. In 1961, it was recognized by Behrndt⁴ that:

$$\frac{M_f}{M_q} = \frac{(T_c - T_q)}{T_q} = \frac{(\Delta F)}{F_c} \quad [3]$$

where T_c and T_q are the periods of oscillation of the crystal with film (composite) and the bare crystal, respectively.

The period measurement technique was the outgrowth of two factors:

- ◆ The digital implementation of time measurement, and
- ◆ The recognition of the mathematically rigorous formulation of the proportionality between the thickness of the crystal, l_q , and the period of oscillation, $T_q = 1/F_q$.

4.K. H. Behrndt, J. Vac. Sci. Technol. 8, 622 (1961)

Electronically, the period measurement technique uses a second crystal oscillator, or reference oscillator, not affected by the deposition, which is usually much higher in frequency than the monitor crystal. This reference oscillator is used to generate small precision time intervals, which are used to determine the oscillation period of the monitor crystal. This is done by using two pulse accumulators:

- ♦ The first is used to accumulate a fixed number of cycles, m , of the monitor crystal.
- ♦ The second is turned on at the same time and accumulates cycles from the reference oscillator until m counts are accumulated in the first.

Since the frequency of the reference is stable and known, the time to accumulate the m counts is known to an accuracy equal to $\pm 2/F_r$ where F_r is the reference oscillator frequency.

The period of the monitor crystal is $(n/F_r)/m$, where n is the number of counts in the second accumulator. The precision of the measurement is determined by the speed of the reference clock and the length of the gate time (set by the size of m). Increasing one or both of these leads to improved measurement precision.

Having a high frequency reference oscillator is important for rapid measurements (which require short gating times), low deposition rates, and low density materials. All of these require high time precision to resolve the small, mass-induced frequency shifts between measurements.

When the change of a monitor crystal frequency between measurements is small, that is, on the same order of size as the measurement precision, it is not possible to establish quality rate control. The uncertainty of the measurement injects more noise into the control loop, which can be counteracted only by longer time constants. Long time constants cause the correction of rate errors to be very slow, resulting in relatively long term deviations from the desired rate.

These deviations may not be important for some simple films, but can cause unacceptable errors in the production of critical films such as optical filters or very thin-layered superlattices grown at low rates.

In many cases, the desired properties of these films can be lost if the layer-to-layer reproducibility exceeds one, or two, percent. Ultimately, the practical stability and frequency of the reference oscillator limits the precision of measurement for conventional instrumentation.

8.1.3 Z-match Technique

After learning of fundamental work by Miller and Bolef ⁵, which rigorously treated the resonating quartz and deposited film system as a one-dimensional continuous acoustic resonator, Lu and Lewis⁶ developed the simplifying Z-match™ equation in 1972. Advances in electronics taking place at the same time, namely the micro-processor, made it practical to solve the Z-match equation in real-time.

Most deposition process controllers/monitors sold today use this sophisticated equation that takes into account the acoustic properties of the resonating quartz and film system (see [equation \[4\]](#)).

$$T_f = \left(\frac{N_{at} d_q}{\pi d_f F_c Z} \right) \arctan \left(Z \tan \left[\frac{\pi (F_q - F_c)}{F_q} \right] \right) \quad [4]$$

where $Z = (d_q u_q / d_f u_f)^{1/2}$ is the acoustic impedance ratio and u_q and u_f are the shear moduli of the quartz and film, respectively.

Finally, there was a fundamental understanding of the frequency-to-thickness conversion that could yield theoretically correct results in a time frame that was practical for process control.

To achieve this new level of accuracy requires only that the user enter an additional material parameter, Z , for the film being deposited. This equation has been tested for a number of materials, and has been found to be valid for frequency shifts equivalent to $F_f = 0.4F_q$.

Keep in mind that [equation \[2\]](#) was valid to only $0.02F_q$ and [equation \[3\]](#) was valid only to $\sim 0.05F_q$.

5.J. G. Miller and D. I. Bolef, J. Appl. Phys. 39, 5815, 4589 (1968)

6.C. Lu and O. Lewis, J Appl. Phys. 43, 4385 (1972)

Appendix A

Material Table

A.1 Introduction

The following [Table A-1](#) represents the density and Z-Ratio for various materials. The list is alphabetical, by chemical formula.



WARNING

Some of these materials are toxic. Consult the material safety data sheet and safety instructions before use.

An * is used to indicate that a Z-Ratio has not been established for a certain material. A value of 1.000 is defaulted in these situations.

Table A-1 Material table

Formula	Density	Z-Ratio	Material Name
Ag	10.500	0.529	silver
AgBr	6.470	1.180	silver bromide
AgCl	5.560	1.320	silver chloride
Al	2.700	1.080	aluminum
Al ₂ O ₃	3.970	0.336	aluminum oxide
Al ₄ C ₃	2.360	*1.000	aluminum carbide
AlF ₃	3.070	*1.000	aluminum fluoride
AlN	3.260	*1.000	aluminum nitride
AlSb	4.360	0.743	aluminum antimonide
As	5.730	0.966	arsenic
As ₂ Se ₃	4.750	*1.000	arsenic selenide
Au	19.300	0.381	gold
B	2.370	0.389	boron
B ₂ O ₃	1.820	*1.000	boron oxide
B ₄ C	2.370	*1.000	boron carbide
BN	1.860	*1.000	boron nitride
Ba	3.500	2.100	barium
BaF ₂	4.886	0.793	barium fluoride
BaN ₂ O ₆	3.244	1.261	barium nitrate

Table A-1 Material table (continued)

Formula	Density	Z-Ratio	Material Name
BaO	5.720	*1.000	barium oxide
BaTiO ₃	5.999	0.464	barium titanate (tetr)
BaTiO ₃	6.035	0.412	barium titanate (cubic)
Be	1.850	0.543	beryllium
BeF ₂	1.990	*1.000	beryllium fluoride
BeO	3.010	*1.000	beryllium oxide
Bi	9.800	0.790	bismuth
Bi ₂ O ₃	8.900	*1.000	bismuth oxide
Bi ₂ S ₃	7.390	*1.000	bismuth trisulfide
Bi ₂ Se ₃	6.820	*1.000	bismuth selenide
Bi ₂ Te ₃	7.700	*1.000	bismuth telluride
BiF ₃	5.320	*1.000	bismuth fluoride
C	2.250	3.260	carbon (graphite)
C	3.520	0.220	carbon (diamond)
C ₈ H ₈	1.100	*1.000	parlyene (union carbide)
Ca	1.550	2.620	calcium
CaF ₂	3.180	0.775	calcium fluoride
CaO	3.350	*1.000	calcium oxide
CaO-SiO ₂	2.900	*1.000	calcium silicate (3)
CaSO ₄	2.962	0.955	calcium sulfate
CaTiO ₃	4.100	*1.000	calcium titanate
CaWO ₄	6.060	*1.000	calcium tungstate
Cd	8.640	0.682	cadmium
CdF ₂	6.640	*1.000	cadmium fluoride
CdO	8.150	*1.000	cadmium oxide
CdS	4.830	1.020	cadmium sulfide
CdSe	5.810	*1.000	cadmium selenide
CdTe	6.200	0.980	cadmium telluride
Ce	6.780	*1.000	cerium
CeF ₃	6.160	*1.000	cerium (iii) fluoride
CeO ₂	7.130	*1.000	cerium (iv) dioxide
Co	8.900	0.343	cobalt
CoO	6.440	0.412	cobalt oxide

Table A-1 Material table (continued)

Formula	Density	Z-Ratio	Material Name
Cr	7.200	0.305	chromium
Cr ₂ O ₃	5.210	*1.000	chromium (iii) oxide
Cr ₃ C ₂	6.680	*1.000	chromium carbide
CrB	6.170	*1.000	chromium boride
Cs	1.870	*1.000	cesium
Cs ₂ SO ₄	4.243	1.212	cesium sulfate
CsBr	4.456	1.410	cesium bromide
CsCl	3.988	1.399	cesium chloride
CsI	4.516	1.542	cesium iodide
Cu	8.930	0.437	copper
Cu ₂ O	6.000	*1.000	copper oxide
Cu ₂ S	5.600	0.690	copper (i) sulfide (alpha)
Cu ₂ S	5.800	0.670	copper (i) sulfide (beta)
CuS	4.600	0.820	copper (ii) sulfide
Dy	8.550	0.600	dysprosium
DY ₂ O ₃	7.810	*1.000	dysprosium oxide
Er	9.050	0.740	erbium
Er ₂ O ₃	8.640	*1.000	erbium oxide
Eu	5.260	*1.000	europium
EuF ₂	6.500	*1.000	europium fluoride
Fe	7.860	0.349	iron
Fe ₂ O ₃	5.240	*1.000	iron oxide
FeO	5.700	*1.000	iron oxide
FeS	4.840	*1.000	iron sulfide
Ga	5.930	0.593	gallium
Ga ₂ O ₃	5.880	*1.000	gallium oxide (b)
GaAs	5.310	1.590	gallium arsenide
GaN	6.100	*1.000	gallium nitride
GaP	4.100	*1.000	gallium phosphide
GaSb	5.600	*1.000	gallium antimonide
Gd	7.890	0.670	gadolinium
Gd ₂ O ₃	7.410	*1.000	gadolinium oxide
Ge	5.350	0.516	germanium

Table A-1 Material table (continued)

Formula	Density	Z-Ratio	Material Name
Ge ₃ N ₂	5.200	*1.000	germanium nitride
GeO ₂	6.240	*1.000	germanium oxide
GeTe	6.200	*1.000	germanium telluride
Hf	13.090	0.360	hafnium
HfB ₂	10.500	*1.000	hafnium boride
HfC	12.200	*1.000	hafnium carbide
HfN	13.800	*1.000	hafnium nitride
HfO ₂	9.680	*1.000	hafnium oxide
HfSi ₂	7.200	*1.000	hafnium silicide
Hg	13.460	0.740	mercury
Ho	8.800	0.580	holmium
Ho ₂ O ₃	8.410	*1.000	holmium oxide
In	7.300	0.841	indium
In ₂ O ₃	7.180	*1.000	indium sesquioxide
In ₂ Se ₃	5.700	*1.000	indium selenide
In ₂ Te ₃	5.800	*1.000	indium telluride
InAs	5.700	*1.000	indium arsenide
InP	4.800	*1.000	indium phosphide
InSb	5.760	0.769	indium antimonide
Ir	22.400	0.129	iridium
K	0.860	10.189	potassium
KBr	2.750	1.893	potassium bromide
KCl	1.980	2.050	potassium chloride
KF	2.480	*1.000	potassium fluoride
KI	3.128	2.077	potassium iodide
La	6.170	0.920	lanthanum
La ₂ O ₃	6.510	*1.000	lanthanum oxide
LaB ₆	2.610	*1.000	lanthanum boride
LaF ₃	5.940	*1.000	lanthanum fluoride
Li	0.530	5.900	lithium
LiBr	3.470	1.230	lithium bromide
LiF	2.638	0.778	lithium fluoride
LiNbO ₃	4.700	0.463	lithium niobate

Table A-1 Material table (continued)

Formula	Density	Z-Ratio	Material Name
Lu	9.840	*1.000	lutetium
Mg	1.740	1.610	magnesium
MgAl ₂ O ₄	3.600	*1.000	magnesium aluminate
MgAl ₂ O ₆	8.000	*1.000	spinel
MgF ₂	3.180	0.637	magnesium fluoride
MgO	3.580	0.411	magnesium oxide
Mn	7.200	0.377	manganese
MnO	5.390	0.467	manganese oxide
MnS	3.990	0.940	manganese (ii) sulfide
Mo	10.200	0.257	molybdenum
Mo ₂ C	9.180	*1.000	molybdenum carbide
MoB ₂	7.120	*1.000	molybdenum boride
MoO ₃	4.700	*1.000	molybdenum trioxide
MoS ₂	4.800	*1.000	molybdenum disulfide
Na	0.970	4.800	sodium
Na ₃ AlF ₆	2.900	*1.000	cryolite
Na ₅ Al ₃ F ₁₄	2.900	*1.000	chiolite
NaBr	3.200	*1.000	sodium bromide
NaCl	2.170	1.570	sodium chloride
NaClO ₃	2.164	1.565	sodium chlorate
NaF	2.558	1.645	sodium fluoride
NaNO ₃	2.270	1.194	sodium nitrate
Nb	8.578	0.492	niobium (columbium)
Nb ₂ O ₃	7.500	*1.000	niobium trioxide
Nb ₂ O ₅	4.470	*1.000	niobium (v) oxide
NbB ₂	6.970	*1.000	niobium boride
NbC	7.820	*1.000	niobium carbide
NbN	8.400	*1.000	niobium nitride
Nd	7.000	*1.000	neodymium
Nd ₂ O ₃	7.240	*1.000	neodymium oxide
NdF ₃	6.506	*1.000	neodymium fluoride
Ni	8.910	0.331	nickel
NiCr	8.500	*1.000	nichrome

Table A-1 Material table (continued)

Formula	Density	Z-Ratio	Material Name
NiCrFe	8.500	*1.000	Inconel
NiFe	8.700	*1.000	permalloy
NiFeMo	8.900	*1.000	supermalloy
NiO	7.450	*1.000	nickel oxide
P ₃ N ₅	2.510	*1.000	phosphorus nitride
Pb	11.300	1.130	lead
PbCl ₂	5.850	*1.000	lead chloride
PbF ₂	8.240	0.661	lead fluoride
PbO	9.530	*1.000	lead oxide
PbS	7.500	0.566	lead sulfide
PbSe	8.100	*1.000	lead selenide
PbSnO ₃	8.100	*1.000	lead stannate
PbTe	8.160	0.651	lead telluride
Pd	12.038	0.357	palladium
PdO	8.310	*1.000	palladium oxide
Po	9.400	*1.000	polonium
Pr	6.780	*1.000	praseodymium
Pr ₂ O ₃	6.880	*1.000	praseodymium oxide
Pt	21.400	0.245	platinum
PtO ₂	10.200	*1.000	platinum oxide
Ra	5.000	*1.000	radium
Rb	1.530	2.540	rubidium
RbI	3.550	*1.000	rubidium iodide
Re	21.040	0.150	rhenium
Rh	12.410	0.210	rhodium
Ru	12.362	0.182	ruthenium
S ₈	2.070	2.290	sulfur
Sb	6.620	0.768	antimony
Sb ₂ O ₃	5.200	*1.000	antimony trioxide
Sb ₂ S ₃	4.640	*1.000	antimony trisulfide
Sc	3.000	0.910	scandium
Sc ₂ O ₃	3.860	*1.000	scandium oxide
Se	4.810	0.864	selenium

Table A-1 Material table (continued)

Formula	Density	Z-Ratio	Material Name
Si	2.320	0.712	silicon
Si ₃ N ₄	3.440	*1.000	silicon nitride
SiC	3.220	*1.000	silicon carbide
SiO	2.130	0.870	silicon (ii) oxide
SiO ₂	2.648	1.000	silicon dioxide
Sm	7.540	0.890	samarium
Sm ₂ O ₃	7.430	*1.000	samarium oxide
Sn	7.300	0.724	tin
SnO ₂	6.950	*1.000	tin oxide
SnS	5.080	*1.000	tin sulfide
SnSe	6.180	*1.000	tin selenide
SnTe	6.440	*1.000	tin telluride
Sr	2.600	*1.000	strontium
SrF ₂	4.277	0.727	strontium fluoride
SrO	4.990	0.517	strontium oxide
Ta	16.600	0.262	tantalum
Ta ₂ O ₅	8.200	0.300	tantalum (v) oxide
TaB ₂	11.150	*1.000	tantalum boride
TaC	13.900	*1.000	tantalum carbide
TaN	16.300	*1.000	tantalum nitride
Tb	8.270	0.660	terbium
Tc	11.500	*1.000	technetium
Te	6.250	0.900	tellurium
TeO ₂	5.990	0.862	tellurium oxide
Th	11.694	0.484	thorium
ThF ₄	6.320	*1.000	thorium (iv) fluoride
ThO ₂	9.860	0.284	thorium dioxide
ThOF ₂	9.100	*1.000	thorium oxyfluoride
Ti	4.500	0.628	titanium
Ti ₂ O ₃	4.600	*1.000	titanium sesquioxide
TiB ₂	4.500	*1.000	titanium boride
TiC	4.930	*1.000	titanium carbide
TiN	5.430	*1.000	titanium nitride

Table A-1 Material table (continued)

Formula	Density	Z-Ratio	Material Name
TiO	4.900	*1.000	titanium oxide
TiO ₂	4.260	0.400	titanium (iv) oxide
Tl	11.850	1.550	thallium
TlBr	7.560	*1.000	thallium bromide
TlCl	7.000	*1.000	thallium chloride
TlI	7.090	*1.000	thallium iodide (b)
U	19.050	0.238	uranium
U ₃ O ₈	8.300	*1.000	tri uranium octoxide
U ₄ O ₉	10.969	0.348	uranium oxide
UO ₂	10.970	0.286	uranium dioxide
V	5.960	0.530	vanadium
V ₂ O ₅	3.360	*1.000	vanadium pentoxide
VB ₂	5.100	*1.000	vanadium boride
VC	5.770	*1.000	vanadium carbide
VN	6.130	*1.000	vanadium nitride
VO ₂	4.340	*1.000	vanadium dioxide
W	19.300	0.163	tungsten
WB ₂	10.770	*1.000	tungsten boride
WC	15.600	0.151	tungsten carbide
WO ₃	7.160	*1.000	tungsten trioxide
WS ₂	7.500	*1.000	tungsten disulfide
WSi ₂	9.400	*1.000	tungsten silicide
Y	4.340	0.835	yttrium
Y ₂ O ₃	5.010	*1.000	yttrium oxide
Yb	6.980	1.130	ytterbium
Yb ₂ O ₃	9.170	*1.000	ytterbium oxide
Zn	7.040	0.514	zinc
Zn ₃ Sb ₂	6.300	*1.000	zinc antimonide
ZnF ₂	4.950	*1.000	zinc fluoride
ZnO	5.610	0.556	zinc oxide
ZnS	4.090	0.775	zinc sulfide
ZnSe	5.260	0.722	zinc selenide
ZnTe	6.340	0.770	zinc telluride

Table A-1 Material table (continued)

Formula	Density	Z-Ratio	Material Name
Zr	6.490	0.600	zirconium
ZrB ₂	6.080	*1.000	zirconium boride
ZrC	6.730	0.264	zirconium carbide
ZrN	7.090	*1.000	zirconium nitride
ZrO ₂	5.600	*1.000	zirconium oxide

This page is intentionally blank.