

The world of electrical safety

2014/2015

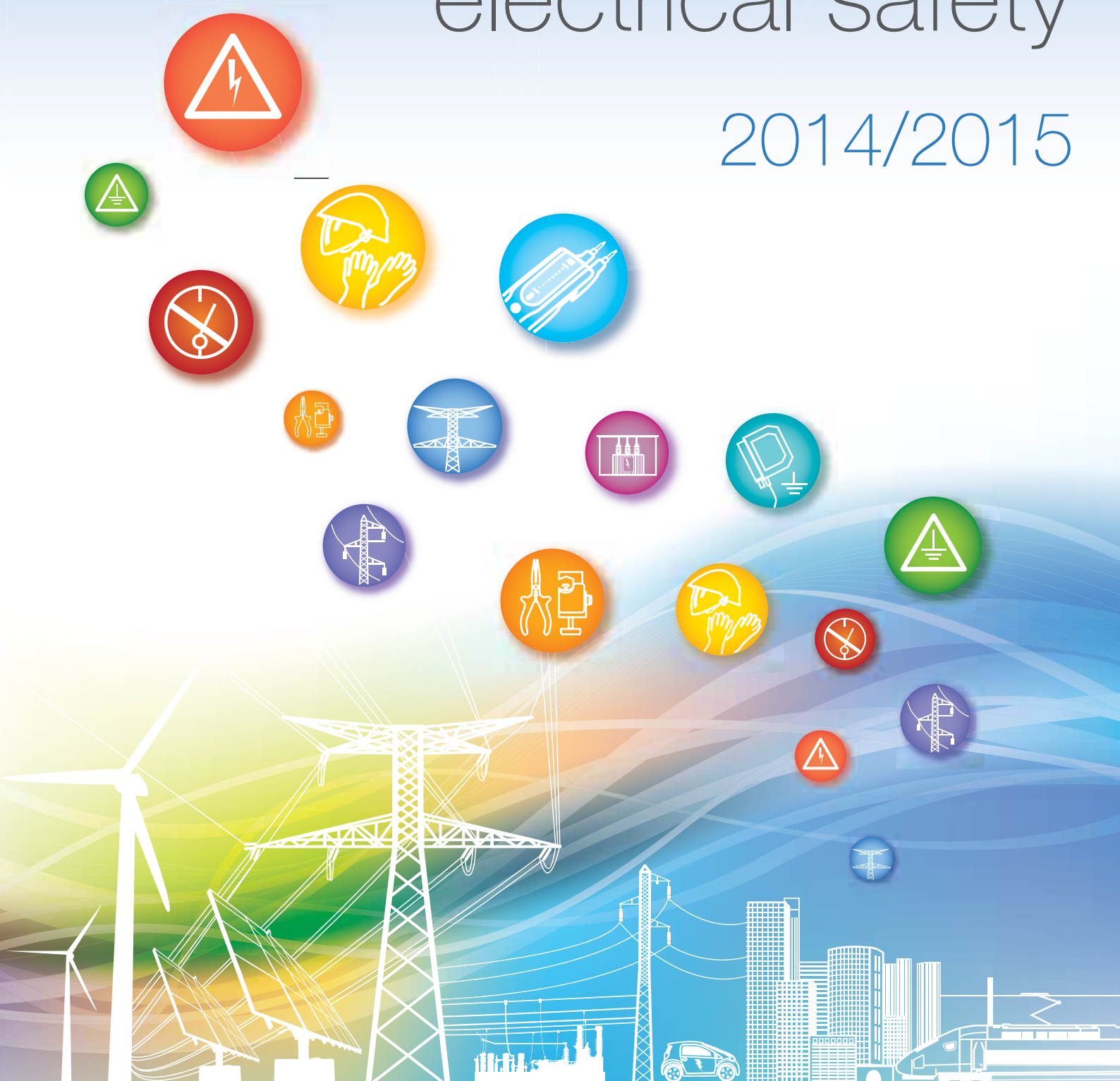



Electrical safety,
our business.

Now more than ever, working safely is essential for all professionals in the electrical industry.

In Europe and in the rest of the world, new clearances allow a larger population of people to perform electrical and non-electrical work on or around installations and structures, in compliance with prevention rules.

This major change, supports better risk analysis and strict adherence to the supervision chain, in order to further improve operator safety.

From this standpoint, CATU is fully committed to supporting you in these changes.

Firstly, with many new products designed and produced by our teams for you.

Next, with a completely redesigned catalogue that focuses on our products, their functions, and their use.

Finally, with new educational tools, including our convenient guides that provide simple and helpful information.

It's time to work with lasting safety, and we are here to help you, the Pros!



Thank you for your confidence in us!

Pierre-Adrien François

Managing Director, CATU

Electrical safety,
for pros like you!



IEC













TESTING
ACCREDITATION N°1 - 0897
SCOPE AVAILABLE ON
www.cofrac.fr



ISO 9001 - ILO-OSH 2001
OHSAS 18001 - ISO 14001

CONTENTS

Personal and collective protective equipment		15
Locking		51
Signaling		65
LV test and measurement		71
LV earthing systems		83
LV Live working tools		89
MV Substation equipment		123
Medium voltage equipment		141
HV lines and switchgear equipment		155
Earthing connections		165

Personal and collective protective equipment.....15

PPE, CPE : key advantages in risk prevention	17
Eyes protection	18
Head protection	19
Insulating rubber gloves.....	22
Insulating boots	27
Insulating mats and accessories	29
Safety shoes	27
Accessories and insulating platforms	30
Arc Flash Protection	31
Arc Flash equipment	33
Workwear and other protections.....	36
Other protection	37
Work at height	38
Equipment for working on pole: harness.....	39
Equipment for working on pole: harness and anti-fall	40
Equipment for working on pole: anti-fall and tether.....	41
Equipment for working on pole: tether and safety line	42
Equipment for working on pole: ropes and snap hooks	43
Equipment for working on pole: snap hooks and anchoring accessories.....	44
Equipment for working on pole: climbers and accessories.....	45
Equipment for working on pole: insulating ladders	46
Equipment for working on pole: insulating ladders and stepladders	47
Equipment for working on pole: ladders and accessories	49

Locking51

Locking padlocks	52
Multiple lockers	56
Padlock stations.....	58
Circuit breaker lockers	59
Circuit breaker lockers, Panels and insert.....	60
Fluid locking	61
Lockers.....	63
Cabinets	64

Signaling.....65

Warning signs	66
Signaling and delineators	69

LV test and measurement71

Voltage Detector	72
Phase rotation indicator	77
Installation Controller	80

LV earthing systems83

Overhead bare	84
Overhead insulating	86
LV Cabinets	87

LV Live working tools89

Insulated tools	91
Jumper clamps, cables and accessories	115
Cover-up equipment	118
Cable identifier.....	122

GENERAL PRODUCTS INDEX

MV Substation equipment123

Substation equipment	125
Voltage detectors and short-circuiting systems for substations with bare conductors.....	126
Voltage detectors	127
Phase comparators	129
Two-pole phase comparator and permanent indicator	130
IEC short-circuiting and earthing systems for MV substations	131
Clamps for MV installations and substations....	133
Short-circuiting and earthing systems.....	134
VPIs and VDS systems for M.V. cubicles	136
Extra safety equipment	138
Life saving kits.....	140

Medium voltage equipment ..141

IEC voltage detectors	142
Voltage detectors	143
Single phase comparators.....	144
IEC equipment	145
Insulating sticks.....	146
Clamp dispenser heads and accessories	148
Overhead line systems.....	149
Cables	150
Underground systems	152
Sticks accessories	153

HV lines and switchgear equipment155

Voltage detectors	156
Insulating sticks.....	158
Clamps	159
Earthing system APE	160
Insulating sticks and earth clamps	161
Copper and aluminium cables.....	162
Accessories	163

Earthing connections.....165

Earth rods	166
Connectors and earth tester	167
Earth resistance tester	167

Golden safety rules.....	169
Specification for short-circuiting and earthing system.....	171
Choose your gloves size	170
Choose your harness size	172

ABS helmet	19	Delineators	69	IEC electronic Voltage Detectors, "Compact serie" for indoor and outdoor use.....	126
AC voltage detector for outdoor/indoor use....	156	Double lanyard	42	IEC Insulating stick for Voltage Detector	126
Accessories (measurement kit)	167	Double safety descent device	43	IEC short-circuiting and earthing systems (three-phase crossarm networks)	132
Adhesive tape	121	Double tether rope with energy absorber	42	IEC Voltage detector	142
Adjustable access points	163			Installation on bare conductors	132
Ratchet spanners.....	109			Installation on permanent fixed points.....	131
Aluminium cables.....	151/162	Earth clamp	131	Insulating blanket	152
Anti-fall device with automatic release strap	41	Earth rod	148	Insulating boots	27
Aperture Housing	138	Earthing equipment	86	Insulating flexible cover	120
"Arc flash" face shield kit	33	Earthing equipment for overhead lines systems.....	84	Insulating flexible cover with Velcro™ tape.....	120
"Arc flash" jacket and protective coverall kits	34	Electrician coverall	36	Insulating gloves.....	22
"Arc flash" protective kits (25, 40, 55, 65 or 100 cal/cm ²)	34/35	End cutting pliers.....	99	Insulating ladders	46
		Equipotential Lines	162	Insulating mats.....	28
				Insulating platform (outdoor model)	30
		Face shield	18/19	Insulating platforms (indoor models)	30
		Fall arrester retractable type	41	Insulating stepladders.....	48
Bag for insulator cover.....	118	Fixed length sticks.....	146	Insulating sticks for manoeuvring detectors & short-circuiting and earthing systems....	158
Bags for insulating mats	29	Fixing tools for warning signs	70	Insulating sticks for short circuiting and earthing systems	147
Bent snipe nose plier	93/98	Flat nose plier.....	93/99	Insulating sticks for substation use	135
Blanket clamp.....	121	Flexible - type conductor cover	118	Insulating tool kits	110
		Folding stepladder with railing	48	Insulating torque wrench 3/8"	109
		Forged steel climbers for round wooden poles	45	Insulation controller	81
Cable cutter.....	92/100/102	Frontal ratchet cable cutter	102	Insulator cover.....	118
Cable Identifier	122	Full body fall arrest harness.....	39	Integrated voltage detecting system (V.D.S)	136
Cable spike equipment	152	Fuse puller	154	Integrated voltage presence indicating system (V.P.I.S)	136
Cable testing stick	152			Interface for integrated voltage detecting system (V.D.S)	137
Carrying bag	26/75/77/162	Grounding and continuity measurement device	80	Intervention kit	94/110
Chain delineators.....	70	Grounding flags	69	Intervention kit for electricians.....	114
Clamp dispenser heads	148			Intervention kits Substation equipment	125
Clamps for installation on bare conductors	133				
Cleaning brushes	154	Hacksaw	102	Jumper cable with insulating jumper clamps	116
Cold Protection Kit and Cap	37	Hand stick	79	Jumper cables realisation specially manufactured items	151
Come-along.....	149	Helmet with built-in face shield	20	Jumper connecting box with fuse	117
Compact carrying KIT	139	HV and EHV clamps manoeuvrable by insulating stick.....	159		
Complete intervention kit.....	94/110				
Connection adaptors for insulating sticks	153				
Connector.....	167				
Constraint tie	44				
Contact probes for L.V. tester	79				
Copper cables	150/161				
Copper/steel earth rods	166				
Cranked ring spanner	104				

GENERAL PRODUCTS INDEX

Lanyard.....	43	Ratchet cable cutter	102	Standard extension ladders	47
Lead set for checks on L.V distribution board.....	79	Rescue hook.....	139	Standard sticks.....	135
LED's headlamp.....	21	Rope operated clamp.....	163	Sticks with rain skirts	147
LED's headlamp (4 LED's).....	21	Round nose plier	93/98	Storage bag	79
Life saving kits for M.V. substations	140	Rubber gloves box	25	Stripping plier for LV cables	101
Long nose pliers with side cutter	98			Substation signs	67
Lockers.....	56/57/59/60/63	Safety adhesive tape	70		
Low voltage complete set. Complete equipment for live line (LV) interventions...113		Safety boots	37	Tap off box	117
Lowlock system.....	86	Safety boundary post.....	69	Telescopic stick for voltage detector	135
		Safety glasses	18	Tether rope with a tension device.	41
		Safety lamps	138	Threaded adapter	117
		Safety rope with wear tell tales.....	43	Tool bag	111/112
Manœuvring and rescue stick	138	Safety Shoes	27	Tool bag for safety harness.....	40
Manœuvring hook.....	154	Scissors.....	109	Trimmer and pruning saw	154
Mechanical climbers for rectangular shaped concrete poles.....	45	Screwdrivers PHILLIPS	91/96/97	Two-pole phase comparator for indoor and outdoor use	130
Mechanical climbers for round and hexagonal concrete poles.....	45	Screwdrivers POZIDRIV	91/97		
Mini jumper clamps fully insulating for switchboard use.....	115	Screwdrivers kit.....	94/95/110		
Mittens	26	Self adhesive warning signs	68	Undergloves	26
Mobile safety line	42	Separable voltage detecting system (V.D.S)	137	Undergloves Nomex III ®.....	32
Multi-pockets electrician bag.....	30	Set of sticks.....	158	Universal pliers.....	98
Multiple Locker.....	56	Short length stick	135		
		Short-circuiting and earthing systems...134/135		Voltage Detectors and Testers.....	72/74
		Short-circuiting and earthing systems carrying bags	162	Voltage detector with leds for indoor use (Compact serie) without batteries	128
Open jaw spanner.....	104	Short-circuiting systems HV.....	159	Voltage detector with leds for indoor use without batteries.....	128
Operating Testers.....	129	Short-circuiting systems LV	84	Voltage detectors and indicators.....	137
Overglasses.....	18	Short-circuiting system MV.....	145	Voltage take-off punch.....	78
Overgloves	26	Short-circuiting system MV substation.....	131	Voltage tester for M.V. separable connectors	137
		Shunt Telescopic probe.....	117		
		Side cutters.....	93/98	Wall mounted supports	139
Padlocks.....	53	Single pole phase comparator for indoor and outdoor use	144	Warning flags	69
Permanent luminous indicator for indoor use	130	Snap hook with double safety latch	43	Warning signs.....	68
Phase rotation indicator.....	77	Snap hook with stick adaptor.....	44	Water pump plier.....	93
Pliers.....	94	Snap hooks (aluminium alloy).....	44	Wire Gun Tester	163
Pliers kit	100	Snap hooks (stainless steel).....	44	Wire stripping plier	92/101
Plug plier for preinsulating pin terminals.....	98	Socket 3/8" - 6 sided male hex Key	107	Work Gloves	36
Pneumatic glove tester	25	Sockets 3/8" Long series.....	107	Working on pole kits	40
Polycarbonate helmet	19	Sockets 3/8" U.S Standard	106		
Pro electric full body fall arrest harness	39	Sockets wrenches sets.....	108		
		Sound phase comparator.....	136		
		Spool with earthing connection.....	148		
		Stainless steel earth rods.....	166		
		Standard electronic voltage detector for indoor and outdoor use.....	143		

References	Pages
A2C-10-Z	166
A2C-15-Z	166
A3MC-10-Z	166
A3MC-15-Z	166
AC-10-Y	166
AC-15-Y	166
AC-20-Y	166
AC-21	70
AC-44	70
AD-01	70
AL-127	70
AL-129	70
AL-138	70
AL-200	57
AL-201-C/1	59
AL-201/1	59
AL-202	57
AL-203	57
AL-204	60
AL-205	59
AL-205/5	59
AL-207/30	58
AL-208-C	59
AL-208-D	59
AL-209-L	60
AL-212	58
AL-230-(**)-EX	53
AL-230-111	114
AL-230-S-(**)-EX	53
AL-230-S-Z-EX	53
AL-230-Z-EX	53
AL-236-00-EX	58
AL-236-111-EX	58
AL-236-222-EX	58
AL-236-S-00-EX	58
AL-236-S-111-EX	58
AL-236-S-222-EX	58
AL-240-(**)-EX	53
AL-240-B-00-EX	53
AL-240-B-111-EX	53
AL-240-B-222-EX	53
AL-240-B-Z-EX	53
AL-240-BL-00-EX	53
AL-240-BL-111-EX	53
AL-240-BL-222-EX	53
AL-240-BL-Z-EX	53
AL-240-J-00-EX	53
AL-240-J-Z-EX	53
AL-240-S-(**)-EX	53
AL-240-S-B-111-EX	53
AL-240-S-B-222-EX	53

References	Pages
AL-240-S-BL-111-EX	53
AL-240-S-BL-222-EX	53
AL-240-S-J-00-EX	53
AL-240-S-J-111-EX	53
AL-240-S-J-222-EX	53
AL-240-S-V-00-EX	53
AL-240-S-V-111-EX	53
AL-240-S-V-222-EX	53
AL-240-S-Z-EX	53
AL-240-V-00-EX	53
AL-240-V-111-EX	53
AL-240-V-222-EX	53
AL-240-V-Z-EX	53
AL-240-Z-EX	53
AL-260-(**)-EX	53
AL-260-00-EX	53
AL-260-S-(**)-EX	53
AL-260-S-00-EX	53
AL-260-S-Z-EX	53
AL-260-Z-EX	53
AL-31	70
AL-31/05	70
AL-31/25	70
AL-316	69
AL-318	69
AL-32/05	70
AL-32/25	70
AL-321	69
AL-322	69
AL-323	69
AL-324	69
AL-53	69
AL-58	69
AL-60	69
AL-62-A	70
AL-63-A	70
AL-65-A	70
ALM-20/45	57
ALM-6/25	57
ALM-6/38	57
ALM-6/8	57
ALP-03	56
ALP-06	56
ALP-12/2M	56
ALP-4/3	56
ALP-4/6	56
AM-20-GB	66
AM-20-RM	67
AM-282/2-RM	67
AM-32/3	67
AM-33/3	67

References	Pages
AM-34/2	67
AM-344	66
AM-344-GB	66
AM-344/05	66
AM-345-GB	66
AM-41/1	66
AM-41/2	66
AM-467-E	60
AM-467-GB	66
AM-49/1	66
AM-49/2	66
AM-61-GB	67
AM-61-RM	67
AM-7002	67
AMI-10	166
AMI-15	166
AP-499/1	60/66
AP-510-BT-GB	66
AP-510-GB	67
AP-951/2	67
AT-41/025	68
AT-41/05	68
AT-41/1	68
AT-49/025	68
AT-49/05	68
AT-49/1	68
AT-50/025	68
AT-50/053	68
AT-50/1	68
AT-5005	70
AT-51/025	68
AT-51/05	68
AT-51/1	68
AT-52/05	68
AT-52/1	68
AT-53/1	68
AT-54/05	68
AT-54/1	68
AT-55/05	68
AT-55/1	68
AT-56/05	68
AT-56/1	68
AT-58/05	68
AT-58/1	68
AT-59/05	68
AT-59/1	68
AT-60/05	68
AT-60/1	68
AT-61/05	68
AT-61/1	68
AT-62/05	68

References	Pages
AT-62/1	68
AT-63/05	68
AT-63/1	68
AT-66/1	68
BCY	167
C-92-20	129
C-92-492	143
C2C-10-Z	166
C2C-15-Z	166
C2C95Z	167
CC-10-Y	166
CC-127-ERDF-C	85
CC-15-Y	166
CC-151-K	137
CC-20-Y	166
CC-245-150-(*)	157
CC-245-150/420-C	157
CC-245-150/420-K	157
CC-245-225/420-(*)	157
CC-245-225/550-C	157
CC-245-225/550-K	157
CC-245-315/765-1-C	157
CC-245-315/765-1-K	157
CC-245-60/150-C	157
CC-245-60/150-K	157
CC-245-63/150-(*)	157
CC-245-63/90-(*)	157
CC-245-90/225-(*)	157
CC-365-10/30-(*)	143
CC-365-101	143
CC-365-3/10...-(*)	143
CC-45-K	137
CC-765-10/30	142
CC-765-10/30-(*)	126
CC-765-10/36	142
CC-765-10/36-(*)	126
CC-765-3/10	142
CC-765-3/10-(*)	126
CC-765-44/132	156
CC-765-55/20	142
CC-765-55/20-(*)	126
CC-965-10/30	127
CC-965-5/15	127
CD-122	138
CD-124	138
CE-3-24-C	135
CE-4-21-	126
CE-4-21-(*)	135/146
CE-4-30-C	146
CE-5-90-C	44
CE-5-90-K	44

GENERAL REFERENCES INDEX

References	Pages
CE-75-(*)	135/146
CF-3-72...-(*)	135
CF-3-90...-(*)	135
CF-5-110-(*)	146
CF-5-170-(*)	146
CF-5-40-(*)	135
CF-5-40-(*)	146
CF-5-90-(*)	135
CF-5-90-(*)	146
CG-05-(*)	24
CG-05-C	114
CG-1-(**)-NR	24
CG-10-(*)	24
CG-117	25
CG-2-(**)-NR	24
CG-2-(**)-NR	24
CG-3-(**)-NR	24
CG-35/2	25
CG-36	26
CG-37	32
CG-4-(**)-NR	24
CG-80-(*)	26
CG-81	26
CG-951-(*)	36
CG-952-(*)	36
CG-96-(*)	36
CG-97-C	36
CG-981-(*)	24/26
CG-991-(*)	26
CG-991-(**)	24
CGA-0-(*)-B	24
CGA-00-(*)-B	24
CGA-1-(*)-NB	24
CGA-2-(**)-NB	24
CGA-3-(**)-NB	24
CGA-4-(**)-NB	24
CGM-0-(*)	25
CGM-00-(*)	25
CGM-1-(*)	25
CGM-2-(*)	25
CGM-3-(*)	25
CGM-4-(**)	25
CI-06-D	132/139/146
CI-08	139/146
CI-10-D	131/139/146
CI-12-D	139/146
CI-70	138
CL-1-06	129
CL-2-10/30-2	128
CL-2-5/36-2	128
CL-4-10/30-2	128

References	Pages
CL-4-10/30-M	128
CL-40010	130
CL-495-3	136
CL-497-00	136
CL-498-00	137
CL-499/101	137
CL-5-03	130
CL-5-36	130
CL-7-06/18-(*)	144
CL-7-10/30-(*)	144
CL-7-10/30-1-(*)	144
CL-7-12/36-(*)	144
CL-8-05	129
CL-8-36/1	129
CM-02-(*)	154
CM-03-K	154
CM-04-K	154
CM-1-10	147
CM-1-15	147
CM-1-20	147
CM-225	138
CM-3-03	147
CM-3-04	147
CM-3-05	147
CM-3-06	147
CM-3900-J	158
CM-4115-(*)	158
CM-4120-(*)	158
CM-4125-(*)	158
CM-4130-(*)	158
CM-4220-(*)	158
CM-4230-(*)	158
CM-4240-(*)	158
CM-4345-(*)	158
CM-4360-(*)	158
CM-4400-J	147
CM-4410	147
CM-4410-(*)	147
CM-4410-I	147
CM-4415	147
CM-4415-(*)	147
CM-4415-I	147
CM-4420	147
CM-4420-(*)	147
CM-4420-I	147
CM-4425	147
CM-4425-(*)	147
CM-4425-I	147
CM-45	138
CM-4610	158
CM-4610-(*)	158

References	Pages
CM-4610-I	158
CM-4615	158
CM-4615-(*)	158
CM-4615-I	158
CM-4620	158
CM-4620-(*)	158
CM-4620-I	158
CM-4625	158
CM-4625-(*)	158
CM-4625-I	158
CM-6-15	161
CM-6-20	161
CM-6-25	161
CM-6-30	161
CM-7-10-A	135/146
CM-90	138
CS-01-C	139
CS-225	138
CS-45	138
CS-90	138
CT-7-25/1	30
CT-7-40/1	30
CT-7-63	30
CT-9-25	30
CT-9-45	30
CT-9-63	30
CX-34211	78
CX-35811	78
CX-45211	78
CX-45411	78
CX-45511	78
CZ-53-MR	139
CZ-53-R	139
CZ-53-R/2	139
CZ-53MR/2	139
CZ-54-R	140
CZ-54-RM	140
CZ-55-R	140
CZ-55-RM	140
CZ-60	140
DT-300	80
DT-500	81
GL-100	62
GL-101	62
HL-100	61
HL-101	61
HL-102	61
HL-103	61
HL-104	61
HL-105	61
HL-200	61

References	Pages
HL-201	61
HL-202	61
HL-203	62
KIT-01	125
KIT-02	125
KIT-03	110
KIT-04	110
KIT-05	110
KIT-07	110
KIT-10	125
KIT-23C	94
KIT-23CH	95
KIT-23P	95
KIT-23PH	95
KIT-23S	94
KIT-23SC2	94
KIT-23SCP	95
KIT-23SH	94
KIT-23SP2	95
KIT-ARC-100-B-(*)	35
KIT-ARC-12-C-(*)	34
KIT-ARC-12-J-(*)	34
KIT-ARC-12-JP-(*)	34
KIT-ARC-25-B-(*)	35
KIT-ARC-40-B-(*)	35
KIT-ARC-65-B-(*)	35
KIT-HAUT-01-(*)	40
KIT-HAUT-02-(*)	40
KIT-HAUT-03-(*)	40
KIT-HAUT-04-(*)	40
KIT-HAUT-05-(*)	40
KIT-HAUT-06-(*)	40
M-187	34
M-24-10	150
M-24-120	150
M-24-120-S	150
M-24-150	150
M-24-150-S	150
M-24-16	150
M-24-16-S	150
M-24-25	150
M-24-25-S	150
M-24-35	150
M-24-35-S	150
M-24-35-V	162
M-24-40	150
M-24-40-S	150
M-24-50	150
M-24-50-S	150
M-24-70	150
M-24-70-S	150

References	Pages
M-24-95	150
M-24-95-S	150
M-28-120	151/162
M-28-150	151/162
M-28-50	151
M-28-70	151/162
M-76768	88
M-78665	131
M-87-153	162
M-87-295	162
M-87-53	162
M-87290	77
M-87290	79
M-87292	79/81
M-87295	34/35
M-87303	112
M-87369	73
M-87369	75/79
M-87370	111
M-87384	20/113
M-87386	30/113
M-87387	30
M-87413	34
M-881601	81
M-881602	81
M-881635	18
M-881837	20
M-881838	20
M-881961	35
M-881968	35
M-881976	35
M-881979	35
M-882462	87
M-882671	20
M-882677	20
M-88896	81
M-91209	87
M-92-28	154
M-921647	80
M-95-236	49
M-951143	79
M-951981	81
M-952206	18
M-952271	79
M-952325	73/75
M-952439	79
M-952650	88
M-952656	87
M-95626/4	87
M-95627/4	87
M-9573	131

References	Pages
M-95864	20
M611386	85
M952567	85
M952568	85
M952570	85
MC-116	117
MC-120/100	116
MC-120/15	116
MC-120/50	116
MC-121	116
MC-122	116
MC-123	116
MC-124	116
MC-126	117
MC-126/1	117
MC-141	115
MC-142	115
MC-1421	122
MC-143	115
MC-144	115
MC-145	115
MC-146	115
MC-147	115
MC-147/1	115
MC-148	115
MC-148/1	115
MC-149	115
MC-150	117
MC-153/05	116
MC-153/10	116
MC-153/30	116
MC-153/60	116
MC-155/05	116
MC-155/10	116
MC-155/20	116
MC-155/30	116
MC-155/60	116
MC-155/80	116
MC-156	117
MC-156/1	117
MC-181	87/88/117
MC-182	88/117
MC-182-8M	88
MC-183	88/117
MC-184-6F	88
MC-184-6M	88
MC-185-10F	88
MC-185-10M	88
MC-296-00/08	87
MC-296-115/08	87
MC-296-160/08	87

References	Pages
MC-296-440	87
MC-296-560	87
MC-296-A	87
MC-296-B	87
MC-296-C	87
MC-296-M	87
MC-296-NFC	88
MC-296-P	87/88
MD-10-C	154
MD-12-C	154
MD-14-C	154
MD-40-B	154
MD-42-B	154
MF-60	163
MF-61	163
MF-62	163
MF-63	163
MF-66	163
MO-02	43
MO-052	43
MO-11000	18/34/35
MO-11001	18/114
MO-11003	18
MO-11010	18
MO-11011	18
MO-134	34
MO-157	37
MO-158	37
MO-16A	45
MO-17-01	45
MO-17-02	45
MO-17-03	45
MO-17-04	45
MO-17-A	45
MO-180-ARC	33
MO-182/1-B	19/34/35
MO-182/1-J	19
MO-182/1-R	19
MO-183-BL	19
MO-183-RL	19
MO-184	19
MO-185-B	20
MO-185-BL	20
MO-185-BLM	20
MO-185-BLMH	20
MO-185-J	20
MO-185-R	20
MO-186	18
MO-187	33
MO-187/1-B	33
MO-23	45

References	Pages
MO-237-D	117
MO-24	45
MO-25	45
MO-26	45
MO-29	45
MO-32/3	40
MO-34	112/113
MO-35	45
MO-36	112
MO-36310	106
MO-37	111
MO-38	111
MO-38510	114
MO-39	111
MO-510-03	113
MO-52-L	41
MO-52-P	41
MO-52020	42
MO-52021	42
MO-52031	44
MO-52033	44
MO-52034	44
MO-53	43
MO-53002	42
MO-53010	42
MO-54	44
MO-54002	43
MO-54004	44
MO-54005-C	44
MO-54005-K	44
MO-54010	42
MO-55/1	44
MO-56010	41
MO-563-(*)	39
MO-565-(*)	39
MO-591000	41
MO-591002	41
MO-592002	41
MO-61	41
MO-61001	101
MO-61002	101
MO-64501	102
MO-64502	102
MO-650-D	96
MO-652-D	96
MO-65200D	96
MO-65202	96
MO-65202D	96
MO-65203	96
MO-65203D	96
MO-65204	96

GENERAL REFERENCES INDEX

References	Pages
MO-65204	110
MO-65204	114
MO-65204D	96
MO-65205	96
MO-652055D	96
MO-65205D	96
MO-65206	96/110/114
MO-65206D	96
MO-65207	96
MO-652082D	96
MO-65208D	96
MO-65209	96/110/114
MO-652102D	96
MO-65210D	96
MO-65211	96
MO-65212D	96
MO-65230	96
MO-65232	96
MO-652321D	96
MO-65232D	96
MO-65233D	96
MO-65234	96
MO-65234D	96
MO-65236	96
MO-65236D	96
MO-65238	96
MO-65238D	96
MO-65240	97
MO-652405D	97
MO-652406D	97
MO-652410D	97
MO-65242	97/110/114
MO-65244	97/110/114
MO-652441D	97
MO-65244D	97
MO-65245D	97
MO-65246	97
MO-65246D	97
MO-65248	97
MO-65248D	97
MO-653-D	96
MO-65405	97
MO-65406	97
MO-65505	97
MO-65506	97
MO-66000C	99
MO-66001	98
MO-66002	98
MO-66002	110/114
MO-66003	98
MO-66005	98

References	Pages
MO-66102	98
MO-66105	98
MO-66202	98
MO-66300	98
MO-66301	98
MO-66302	98/114
MO-66303C	99
MO-66402	98/110/114
MO-66404	98
MO-66404CC	99
MO-66500	99/110
MO-66502	99/110/114
MO-66505	99
MO-67101	100
MO-67102	100
MO-67103	100
MO-67302	101/110
MO-67302C	101
MO-67304	101
MO-67305	101
MO-67306	101
MO-67401	99
MO-67402	99/110
MO-67404	99
MO-67500	100/110/114
MO-67501	100
MO-67502	100
MO-67599	102
MO-67600	102
MO-67601	102
MO-67611	102
MO-67700	100
MO-67701	100
MO-68/10	40
MO-68/15	40
MO-68006	104
MO-68007	104
MO-68008	104
MO-68008/19	104
MO-68009	104
MO-68010	104
MO-68011	104
MO-68012	104
MO-68013	104
MO-68014	104
MO-68015	104
MO-68016	104
MO-68017	104
MO-68018	104
MO-68019	104
MO-68020	104

References	Pages
MO-68021	104
MO-68022	104
MO-68023	104
MO-68024	104
MO-68025	104
MO-68026	104
MO-68027	104
MO-68028	104
MO-68029	104
MO-68030	104
MO-68032	104
MO-68106	104
MO-68107	104
MO-68108	104
MO-68109	104
MO-68110	104
MO-68111	104
MO-68112	104
MO-68113	104
MO-68114	104
MO-68115	104
MO-68116	104
MO-68117	104
MO-68118	104
MO-68119	104
MO-68120	104
MO-68121	104
MO-68122	104
MO-68123	104
MO-68124	104
MO-68125	104
MO-68126	104
MO-68127	104
MO-68128	104
MO-68129	104
MO-68130	104
MO-68132	104
MO-68205	105
MO-68206	105
MO-68207	105
MO-68209	105
MO-68210	105
MO-682101	105
MO-682111	105
MO-682121	105
MO-682131	105
MO-682141	105
MO-682151	105
MO-682161	105
MO-682171	105
MO-682181	105

References	Pages
MO-682191	105
MO-682211	105
MO-68310	105
MO-68311	105
MO-68312	105
MO-68313	105
MO-68314	105
MO-68316	105
MO-68317	105
MO-68319	105
MO-68321	105
MO-68322	105
MO-68402	92
MO-68403	92
MO-68404	92
MO-68405	92
MO-68406	92
MO-68408	92
MO-68610	104
MO-68613	104
MO-68614	104
MO-68620	104
MO-68621	104
MO-687-D	87
MO-68701	103
MO-68702	103
MO-68703	103
MO-68704	103
MO-68705	103
MO-68713	105
MO-68714	105
MO-68717	105
MO-69002	103
MO-69003	103
MO-69004	103
MO-69005	103
MO-69050	109
MO-69051	109
MO-69054	109
MO-69210	103
MO-69213	103
MO-69216	103
MO-69217	103
MO-69218	103
MO-69219	103
MO-69306	106
MO-69307	106
MO-69308	106/108
MO-69308/23	108
MO-69309	106
MO-69310	108

References	Pages
MO-693100	107
MO-69311	106
MO-69312	106/108
MO-69313	106
MO-69314	106/108
MO-69315	
MO-69316	106
MO-69317	106
MO-69318	108
MO-69319	106
MO-69321	106/108
MO-69322	106/108
MO-69323	106/108
MO-69324	108
MO-69393	106
MO-69394	107
MO-69395	107
MO-69396	107
MO-69397	107
MO-69398	107
MO-69408	107/108
MO-69408/23	106
MO-69410	106/108
MO-69412	106/108
MO-69413	106/108
MO-69414	106/108
MO-69415	108
MO-69416	106
MO-69417	106
MO-69418	108
MO-69419	106
MO-69420	108
MO-69421	106
MO-69422	106/108
MO-69423	106/108
MO-69424	108
MO-69429	106
MO-69430	106
MO-69503	106
MO-69512	108
MO-69513	108/109
MO-69514	108/109
MO-69515	109
MO-69523	105/107/109
MO-69524	108
MO-69533	105/108
MO-69544	107
MO-69608	105
MO-69609	107
MO-69610	107
MO-69611	107

References	Pages
MO-69612	107
MO-69613	107
MO-69614	107
MO-69616	107
MO-69617	107
MO-69618	107
MO-69619	107
MO-69621	107
MO-69622	107
MO-69624	107
MO-697-1/4SAE	107
MO-697-15/16	106
MO-697-1SAE	106
MO-697-5/16	106
MO-697-7/8	106
MO-69735	106
MO-69736	106
MO-69737	106
MO-69738	106
MO-69739	106
MO-69740	106
MO-69741	106
MO-69742	106
MO-69903	106
MO-69904	103
MO-69905	103
MO-69906	103
MO-69908	103
MO-69910	103
MO-69912	103
MO-69T15	103
MO-69T20	107
MO-69T30	107
MO-69T40	107
MO-69T50	107
MO-71	107
MO-72002	39
MO-72003	91
MO-72004	91
MO-72004	91
MO-72005	94
MO-72006	91
MO-72006	91
MO-72008	94
MO-72008	91
MO-72010	94
MO-72030	91
MO-72032	91
MO-72034	91
MO-72036	91
MO-72038	91

References	Pages
MO-72040	91
MO-72042	91
MO-72042	91
MO-72044	94
MO-72044	91
MO-72046	94
MO-72048	91
MO-720510	91
MO-720515	91
MO-720520	91
MO-720525	91
MO-720527	91
MO-720530	91
MO-720540	91
MO-720545	91
MO-720550	91
MO-72056	91
MO-72057	91
MO-72058	91
MO-72059	91
MO-72100E	91
MO-72102	109
MO-72102	92
MO-72122	94
MO-72132	93
MO-72142	93
MO-72155	93/94
MO-72162	94
MO-72172	92/93
MO-72200	92/94
MO-72200	94
MO-831	49
MO-832	49
MO-87370	114
MO-87413	33
MO-98208	105
MO54000	44
MO56009	41
MP-01	29
MP-01	113
MP-02	29
MP-100/02-10	29
MP-100/03-10	29
MP-100/03-5	29
MP-100/05-10	29
MP-100/05-5	29
MP-100/10-10	29
MP-100/10-5	29
MP-11/11	29
MP-11/16	29
MP-123	120

References	Pages
MP-123/1	120
MP-123/2	120
MP-19-LOT	121
MP-19/1	121
MP-211	152
MP-212	152
MP-213	152
MP-213/EXT	152
MP-213/LAM	152
MP-22	118
MP-220	120
MP-220/1	120
MP-23	118
MP-26-A	118
MP-26-B	118
MP-26-C	118
MP-26-D	118
MP-26-E	118
MP-31	118
MP-32/10	118
MP-32/15	118
MP-33	118
MP-35	120
MP-35/12	120
MP-37	120
MP-40	121
MP-400	49
MP-400-2	49
MP-402-MB	49
MP-402-MI	49
MP-403-MB	49
MP-403-MI	49
MP-4110	121
MP-41530	121
MP-42/11	29
MP-42/16	29
MP-42/66	29
MP-46501	47
MP-467	49
MP-50	118
MP-501-D	49
MP-502-D	49
MP-503-D	49
MP-506/2	46
MP-508/2	46
MP-509/2	46
MP-510/2	46
MP-514/2	46
MP-515/2R	46
MP-59	118
MP-60/03-10	29

GENERAL REFERENCES INDEX

References	Pages
MP-60/03-5	29
MP-60/05-1	29
MP-60/05-10	29
MP-60/05-5	29
MP-602-D	46
MP-603-D	46
MP-604-D	46
MP-605-D	46
MP-607/2-1	47
MP-607/3-1	47
MP-608/2-1	47
MP-608/3-1	47
MP-609/2-1	47
MP-624/2-D	46
MP-634/2-D	46
MP-700-1	48
MP-700-100	47
MP-700-2	48
MP-700-200	47
MP-700-3	48
MP-700-4	48
MP-700-5	48
MP-700-6	48
MS-124	21
MS-125	21
MS-152+	77
MS-62	78
MS-63	78
MS-8013-2	79
MS-8014-2	79
MS-917-EX	73
MS-917-VE	76
MS-917/2-EX	73
MS-920	75
MT-1910	131
MT-1911	131
MT-1911-E	131
MT-1920	131
MT-1921	131
MT-1921-E	131
MT-1951/10	134
MT-1951/12	134
MT-205	86
MT-206	86
MT-207	86
MT-222	86
MT-223	86
MT-242	84
MT-244	84
MT-245	84
MT-249	84

References	Pages
MT-2950/35	134
MT-2951	134
MT-2951/1	134
MT-2951/2	134
MT-3950/35	134
MT-3951	134
MT-3951/1	134
MT-3952	134
MT-3952/1	134
MT-40	151
MT-404	84
MT-405	84
MT-406	84
MT-407	84
MT-508/36	149
MT-508/46	149
MT-509/3	85
MT-509/3EP	85
MT-509/3VAT	85
MT-546	85
MT-5805	132
MT-615/1-7,5	86
MT-615/2-7,5	86
MT-630-C	148
MT-630-K	148
MT-630-S	148
MT-633-C	148
MT-633-K	148
MT-633-S	148
MT-634-C/K	148
MT-634/1-C/K	148
MT-635/1-C/K/S	148
MT-640-S	148
MT-641-S	148
MT-650	86/148
MT-6613	145
MT-6613/1	145
MT-70/1	151
MT-701/1	163
MT-731-(*)	159
MT-732-(*)	159
MT-734-(**)	159
MT-735-(*)	159
MT-735-P4	162
MT-737-H	159
MT-790	163
MT-792	163
MT-797	163
MT-811-C	133
MT-812-C	133
MT-813-C	133

References	Pages
MT-814/2	133
MT-814/3	133
MT-815-C	133
MT-815-E	133
MT-815-S	133
MT-817-C	133
MT-818-C	133
MT-834-E	160
MT-834-H	160
MT-834-T	160
MT-835-E	160
MT-835-H	160
MT-835-T	160
MT-837-E	160
MT-837-H	160
MT-837-T	160
MT-840	133
MT-840/1	133/148
MT-8408	132
MT-841	133
MT-843	148/161
MT-843-P	161
MT-847	161
MT-852	161
MT-853	161
MT-890	131/132
MT-891	131/132
MT-893	131/132
MT-895	131/132
MT-920-E	134
MT-925-E	134
MT-934	160
MT-935	160
MT-951/1	134
MT-951/2	134
MT-951/3	134
MT-952/1	134
MT-952/2	134
MT-952/3	134
MT-953/08	134
MT-953/12	134
MT-955/08	134
MT-955/12	134
MT-956	134
MT-9801	132
MV-104/ (*)	36
MV-105(*)	33
MV-123-(*)	37
MV-124-(*)	37
MV-131-(*)	37
MV-136-	27

References	Pages
MV-136B-	27
MV-137	27
MV-138/	26
MV-222-	27
MV-223-	27
MV-226-	27
MV-227-	27
MV-228-	27
MX-400	122
MX-400/1	122
MX-400/6	122
MX-400/7	122
MX-404	136
MX-433-T	167
PL-100	63
PL-101	63
PL-102	63
RL-100	58
SL-101	64
SL-102	64
SUP-124	21
TO-2-16	167
TO-2-19	167
TO-3-16/19	167

IEC Standard



International Electrotechnical Commission is a worldwide organization for standardization comprising national electrotechnical committees (NC). The object of the IEC is to promote international cooperation on all questions concerning standardization in the electrical fields. These standards have been approved by more than 50 different countries including Australia, Canada, China, France, Germany, Japan, Russia, Malaysia, Singapore, Mexico, India, Indonesia, South Africa, New Zealand, USA...



A rapid need to perform electrical operations evolved with the time.

This resulted in regional or national working on specific standards without coordination.

IEC standards were developed according to a consensus procedure and approved by recognized body. They provide an adequate answer at worldwide level.

The IEC standard presents benefits to all parties involved:

- for the end-users: it is the guarantee of a suitable and internationally recognized quality equipment,
- for the Testing Laboratories: it determines better standards of testing and control procedures for materials,
- for the manufacturers: it helps them to make a better technico-commercial offer.

CATU Designs, tests and manufactures under the IEC requirements.

CATU Is the first manufacturer to provide a full range of products complying with the IEC standards.

CATU Shows its innovation ability for the welfare of the electrical world.



CATUTM

Personal and collective protective equipment



Eyes protection	18
Head Protection	19
Insulating rubber gloves	22
Insulating boots	27
Insulating mats	28
"Arc Flash" protection	31
Workwear and other protections	36
Work at height	38





Services



Testing Accreditation
n°1-0897
Scope available on
www.cofrac.fr



Technical assistance



After sales services



Training



Testing laboratory



Flexible workshop

After Sales Services

xavier.lebec@catuelec.com

phone: +33 01 42 31 46 85 - fax : +33 01 42 31 46 45

latif.ozmen@catuelec.com

phone: +33 01 42 31 46 86 - fax : +33 01 42 31 46 45

Technical Assistance

corinne.peigne@catuelec.com

phone: +33 01 42 31 46 24 - fax : +33 01 42 31 46 34

pascal.genet@catuelec.com

phone: +33 01 42 31 46 52 - fax : +33 01 42 31 46 34



PPE, CPE:

key advantages in risk prevention.

PPE : Personal Protective Equipment.

PPE are defined as any device or means intended to be worn or held by one person to protect itself against one or several risks liable to threaten its safety or its security.

CPE: Collective protective equipment.

Collective protective equipment for preventing electrical hazards contains all the products that close off the hazard by:

- Distance (marking, signs),
- Obstacles (covers, screen, barrier),
- Insulation (insulating blankets, insulating caps, etc.).

CPE must comply with the standards in force.

PPE within the framework of electrical safety recommendations.

"Personal Protective Equipment is used to protect individuals who work on or near an installation that presents an electrical hazard."

Equipment complying with the standards in force and appropriate for the type of operation and voltage level of the installation must be used.

PPE check

- Every PPE must be verified at least visually before and after every use.
- Regular tests must be made by qualified persons and at least annually.
- If the slightest doubt exists the equipment must be reformed and replaced at once.



THE RESPONSIBILITY OF THE EMPLOYER

- To give free of charge and in a personal way equipment necessary and adapted to the risks,
- To watch over their actual use,
- To ensure the necessary replacement as well as the maintenance and the compliance,
- To inform the users of the risks against whom they are protected.

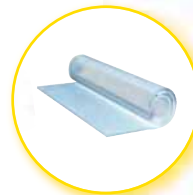

REGULATIONS

The personal protective equipment have to be in compliance with the requirements of the European Directive :

89/391/CEE, on the introduction of measures to encourage improvements in the safety and health of workers at work.

89/655/CEE and **89/656/CEE**, on the minimum health and safety requirements for the use by workers of personal protective equipment at the workplace.

89/686/CEE, on the approximation of the laws of the Member States relating to personal protective equipment (CE marking).



In practice, they define:

- The protections adapted to the kind of risk,
- The highest level of protection possible,
- The comfort, the ergonomics and the quality of the equipment,
- The annual verification of PPE by a competent individual.

The obligations for using PPEs in companies are defined by **the European Directive 89/656**.

Safety glasses

Protection against UV radiation and ejections of solid particles.

Reference	Characteristics	UV protection	Resistance
MO-11000	Clear lenses	99.5 % < 370 nm	Level F Impact: 6 mm steel ball launched at 45 m/s
MO-11001	Tinted lenses	99.5 % < 370 nm	
MO-11003*	Tinted lenses	99.5 % < 370 nm	

Delivered in storage bag.
* EN 169 - 80 °C - FT HTA N°127.



Caution: Do not use for welding operations.



EN 166 / EN 170
CE



MO-11001



MO-11003



Overglasses

Polycarbonate overglasses. Protection against UV radiation and ejections of solid particles.

Reference	Characteristics	UV protection	Resistance
MO-11010	Clear lenses	100 % 180 < 400 nm	Level F Impact: 6 mm steel ball launched at 45 m/s
MO-11011	Green tinted lenses	100 % 180 < 400 nm	

Delivered in storage bag.



Caution: Do not use for welding operations.



EN 166 / EN 170
CE

MO-11010





MO-11011



Face shield

Protective screen that can be used without a helmet.
Protection against electric arcs of short-circuits.
Marking: 2-1.2 CATU 1 B 8 1 000 V.

Reference	Characteristics	 mm	 g
MO-186	Clear face shield	240 L x 325 H	350
M-881635	Spare face shield	For MO-186	350
MO-952206	Spare strap for MO-186		



Caution: Do not use for welding operations.





EN 166 / EN 170
CE



Head protection

Face shield

Protection against electric short-circuit arcs. Face shield adjustable on MO-182 helmet.
3-1,2 GW 1 SN DIN EN 166 8 1000 V.

Reference	UV protection	 mm	 g
MO-184	100 %	470 x 200	170



Caution: Do not use for welding operations.

Adjustable by rubber band.



Acetate face shield





EN 166 / EN 170
CE



Face shield on helmet MO-182/1-B.

ABS helmet

Safety industrial helmet. Standard sizes 53 to 63. Leather trim 21 cm along the inside for added comfort. Multiple adjustments for a perfect fit headband.

Reference	Characteristics	 g
MO-182/1-B	WHITE 	300
MO-182/1-R	RED 	300
MO-182/1-J	YELLOW 	300



MO-182/1-R



MO-182/1-J

Deformable shock-resistant helmet with a "gutter" brim. Size from 53 to 62 cm. Lightweight with a comfort lining.

EN 397 440 V
EN 50365  1 000 V
ANSI Z89.1 20 000 V
CE



Safety chin strap



Side slots for mounting hearing protection.

Built-in cushion for optimum ventilation.

Multiple adjustments for a perfect fit headband: adjustable in 3 mm increments.

Polycarbonate helmet

Protects against vertical and side impacts, very well ventilated. Improved comfort. Adjustable size from 53 to 63 cm.

Reference	Characteristics	 g
MO-183-BL	WHITE 	455
MO-183-RL	RED 	455



MO-183-RL

Deformable shock-resistant helmet.

EN 12492
EN 397 440 V
EN 50365  1 000 V
ANSI Z89.1 20 000 V
CE

Head fit adjustment by milled wheel.

Chinstrap with an easy adjustment buckle. Designed to tear if hooked. (< 25 daN).

6-point cloth lining.



Dimensions



Weight

Helmet with built-in face shield

Industrial helmet with integrated face shield
Approved for protection against electric arcs.
 Electrical isolation 1000 V.

EN 166 / EN 170 / EN 397
 EN 50365 ⚡ 1000 V



Reference	Characteristics	UV protection
MO-185-BL	WHITE ○	100 %
MO-185-R	RED ●	100 %
MO-185-J	YELLOW ●	100 %
MO-185-B	BLUE ●	100 %
MO-185-BLM	WHITE ○ + Chinstrap with a chin	100 %
MO-185-BLMH*	WHITE ○ + Chinstrap with a chin + bag M-87384	100 %



Helmet against electric arc dangers. Page 32.

*N°EDF 37.18.681
 Employment Authorization EDF : SMaRT/RE/001-2006.



Accessories

Reference	Characteristics
M-882677	Spare shield MO-185
M-882671	Spare padded headband chinstrap MO-185
M-881837	RED headband
M-881838	RED/WHITE velcro for identification
M-87384	Bag MO-182, MO-183, MO-184, MO-185 for MO-186 BLACK fabric cover for transporting and protecting helmets and shields
M-95864	4 hooks





LED's headlamp (4 LED's)

Can be carried either on the head or any kind of helmet.

Reference	Characteristics	Sealing	 g
MS-124	5 led's headlamp	IP x 7	75
SUP-124	Adhesive clip	-	15

Powered by 1 battery AA LR6: 20 hours.



Lumens max.:
34 Lumens.

Light wiring for a **wide, short-distance beam** or a **long-range directional beam**, or a combination of the two for optimal lighting. 1 flash mode. Range **32 m.**



Adhesive clip supplied to attach to helmet or shield.

LED's headlamp

Can be carried either on the head or any kind of helmet.

Extra large stray.

The external battery 4-pack can be carried in a pocket or around the waist.

Reference	Characteristics	Sealing	 g
MS-125	Headlamp	IP x 6	80

Adhesive clip supplied to attach to a helmet.



Battery.

Power by 1 battery: 30 h.

Lumens max.:
145 Lumens.

Lighting current for a wide, **short distance beam**, or a **long-range directional**, or the combination of the two for 1 flash mode. Range: 75 m.



Insulating rubber gloves

An essential choice for safety!

Compliance

Insulating gloves offer personal protection against electrical shocks when working on or near live wires. They must comply with the **IEC 60903** and **EN 60903** standards. As a result, they undergo various voltage, ageing, and mechanical testing.

The gloves are individually tested and sold in a sealed plastic bag.



CHARACTERISTICS OF SYMBOLS



- Label with a double triangle symbol IEC 60 417-5216, suitable for work on live wires.



- Label with a mechanical hammer symbol, indicating additional mechanical properties gloves.



All our gloves provide greater comfort and hygiene when used.



Glove Types, Classes, and Categories

There are **2 main types of insulating gloves**:

- **Rubber gloves** provide high dielectric performance. They must be used with leather glove covers for mechanical protection.
- Gloves **with mechanical properties** offer superior mechanical protection against punctures and tears. They eliminate the need for **overgloves**.



Ergonomic shape

With an ergonomic shape our gloves are suitable for any type of hand and are soft and supple which allows good dexterity.

A choice of full size

Sizes from 7 to 12 can cover all requirements (Male / Female).

Bi-color

Bi-color gloves on class 1/2/3/4 allows contrast to rapidly detect any excessive abrasion, cut, tear and other mechanical surface damage that could alter the dielectric properties of the glove.



Clear-marking



Rolled cuff

Rolled cuff for comfort & ease of handling.





Insulating rubber gloves

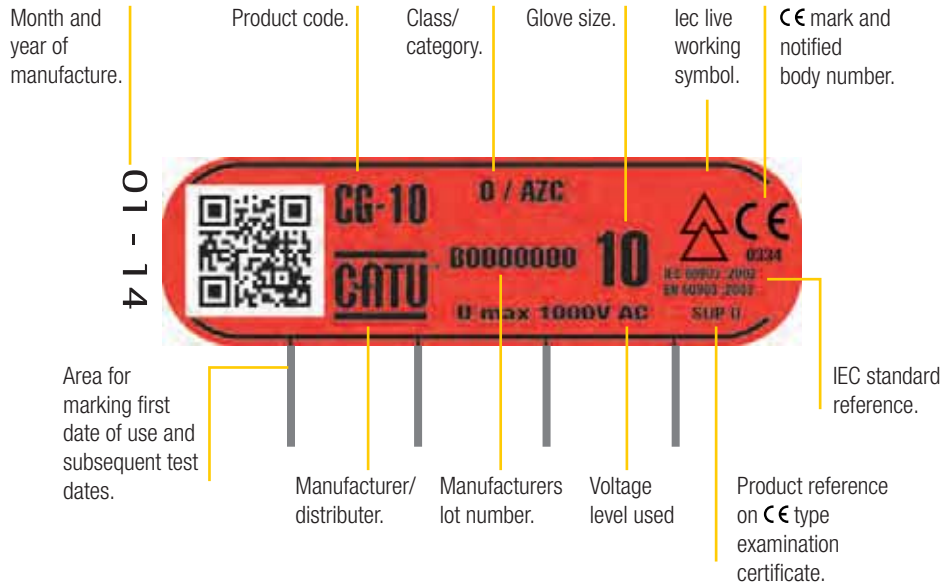

CE

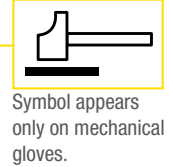

• **Insulating rubber gloves** should be chosen according to their class, which corresponds the voltage level used.

Class	DC	DC
00	500 V _{effective}	750 V
0	1 000 V _{effective}	1 500 V
1	7 500 V _{effective}	11 250 V
2	17 000 V _{effective}	25 500 V
3	26 500 V _{effective}	39 750 V
4	36 000 V _{effective}	54 000 V

• **Insulating rubber gloves** can have other environmental resistance properties, and they are classified into categories.

Category	Resisting in
A	Acid
H	Oil
Z	Ozone
R	Acid, Oil, and Ozone
C	Very low temperature

Note 1: Category R combines the characteristics of Categories A, H, and Z.
 Note 2: Any category combination may be used.

Inspection and Storage of Insulating Gloves



All insulating gloves must be visible inspected after inflation and before each use.

For **Classes 0** and **00**: The tests consist of an air inflation test and a visual inspection when the glove is inflated. The dielectric test is not required, but it may be performed at the owner's request.
 For **Classes 1, 2, 3, and 4**: Even when in storage, a glove should

be used without having been tested within the last six months. Normal testing periods are between 30 and 90 days.

An inspection of the inside of the gloves is also recommended. Gloves should be stored in their packaging, without being compressed or folded. They should not be stored near a heat source with a temperature of 10 to 21°C.

Insulating rubber Gloves

Gloves without mechanical protection for use with silicon leather glove covers.

Reference	Class	Voltage	Category	mm	Color
CG-05-(*)	00	≤ 500 V	AZC	360	Beige
CG-10-(*)	0	≤ 1 000 V	AZC	360	
CG-1-(**)-NR	1	≤ 7 500 V	RC	360	Bi-colour: Red outside. Natural inside
CG-2-(**)-NR	2	≤ 17 000 V	RC	360	
CG-3-(**)-NR	3	≤ 26 500 V	RC	360	
CG-4-(***)-NR	4	≤ 36 000 V	RC	410	

(*) Complete by size codes A=8, B=9, C=10, D=11. (**) Complete by size codes 07 to 12 (sizes 07 and 12 on request). (***) Complete by size codes 08 to 12. (****) Complete by size codes 09 to 12.



Conversion table for insulating rubber gloves and overgloves

GLOVES	GLOVES Reference	GLOVES Size	OVERGLOVES	OVERGLOVES Reference	OVERGLOVES Size
	CG-05-(*) CG-10-(*)	A = 8		CG-981-(*)	8
		B = 9			9
		C = 10			10
		D = 11			11
	CG-1-(**)-NR CG-2-(**)-NR CG-3-(**)-NR CG-4-(**)-NR	7		CG-991-(**)	8
		8			9
9		10			
10		11			
	11		12		

Check your gloves size page 170.

(*) References to be completed by size A, B, C or D. (**) References to be completed by size 07, 08, 09, 10, 11, 12 (07 and 12 on request).

ASTM Insulating Rubber Gloves

Insulating rubber gloves offer personal protection against electrical shocks when working on or near live wires. Our gloves complies with the ASTM standard (ASTM D120). The acceptance levels for mechanical tests are stricter. Our gloves are made of rubber especially treated to obtain high dielectric characteristics and they are individually tested and sold in an individual packaging.

Reference	Class	Voltage	Type	Inch	Color
CGA-00-(*)-B	00	≤ 500 V	I	14	Black
CGA-0-(*)-B	0	≤ 1 000 V	I	14	
CGA-1-(*)-NB	1	≤ 7 500 V	I	14	Bi-colour: Black outside. Natural inside.
CGA-2-(**)-NB	2	≤ 17 000 V	I	14	
CGA-3-(**)-NB	3	≤ 26 500 V	I	14	
CGA-4-(***)-NB	4	≤ 36 000 V	I	16	

(*) Complete by size codes 07 to 12 (sizes 7 and 12 on request). (**) Complete by size codes 08 to 12. (***) Complete by size codes 09 to 12.



Black outside, natural inside.



Insulating rubber gloves

Mechanical gloves

Insulating gloves with higher mechanical properties for working in full safety without leather overgloves.

EN 60903 / IEC 60903



Reference	Class	Voltage	Cat.	mm	Color
CGM-00-(*)	00	≤ 500 V	RC	360	Bi-colour: Orange outside, Natural inside.
CGM-0-(*)	0	≤ 1 000 V	RC	360	
CGM-1-(*)	1	≤ 7 500 V	RC	360	
CGM-2-(*)	2	≤ 17 000 V	RC	360	
CGM-3-(*)	3	≤ 26 500 V	RC	360	
CGM-4-(**)	4	≤ 36 000 V	RC	410	

(*) References to be completed by size 07, 08, 09, 10, 11, 12 (07 and 12 on request).
 (**) References to be completed by size 09, 10, 11, 12

**Arc flash tested: IEC 61482-1-2. Class 2.
 ASTM F2675/F2675M**



Orange outside,
natural inside.



Symbol appears only on mechanical gloves.

Pneumatic glove tester

For compulsory control of gloves before use. Checking is done by inflating and immersing in water.

Reference	Characteristics	g
CG-117 *	Pneumatic glove tester	600

* Delivered in cardboard 140 x 150 x 160.



Gloves box

Specially designed for protecting insulating gloves. Can be fixed on wall.

Reference	mm	g
CG-35/2 *	101 x 224 x 476	900

* Includes a bottle of talcum powder and precautions for use on tape positioned according to the language (English, French, Spanish, German, Italian, Portuguese, Arabic dutch, Chinese, Russian).

Recommended maintenance reminders.



The transparent cover enables to check gloves presence. UV resistant.

Insulating gloves

Carrying bag

Reference	 mm	Characteristics
CG-36	90 X 175 X 585	Reinforced waterproof fabric

Made from reinforced waterproof fabric for transport of rubber gloves in vehicles and tool boxes.



Rear loop for belt and snaps.

Overgloves

Mechanical and electric arc protection.

Reference	Size	
CG-981-(*)	A = 8	160
	B = 9	
	C = 10	
	D = 11	
CG-991-(*)	A = 8	200
	B = 9	
	C = 10	
	D = 11	
	E = 12	

(*) References to be completed by size A, B, C or D. See the conversion table page 24 for the correct size based on the insulated glove.



Silicon grain leather, very flexible.

Large protective cuff in chrome tanned hide.

CG-981-(*)

3122 



Silicon goat grain leather.

Large protective cuff.

CG-991-(*)

2121 

EN 388 
EN 420 

Undergloves

These washable cotton undergloves improve the use of the insulating gloves. They bring the best held, hygiene and a greater comfort.

Reference	Size	
CG-80-(*)	H = Men F = Women	28

(*) References to be completed by size H or F.



Washable cotton undergloves.

CE

Mittens

Fingerless gloves shape allowing to keep the maximum of dexterity.

Reference	Size	
CG-81	One size	20

Cotton mittens, limit the effects of perspiration and its fingerless gloves shape allowing to keep the maximum of dexterity.



CE

Insulating over shoes

Overshoes which provide electrical insulation to protect operators against the risk of a current flow from the feet to the ground or a step voltage. Adapted to a temporary and frequent use.

Reference	Size
MV-138/*	M (39 to 42), L (43 to 45), XL (46 to 48)

* Indicate the size.

Classe 0:
1 kV AC - 1.5 kV DC.



Can be used on footwear.

MV-138

EN 20347 / EN 50321 

CE



Insulating boots

Insulating boots

Provide electrical insulation protecting "step voltages."
No metallic element.

Reference	Size	Class	Voltage
MV-136-*		0	1 000V AC
MV-136B-*	39 to 49	0	1 000V AC
MV-137		-	Tested 20 kV

* Add size to the reference. Ex: MV-137-43.

Provides protection against step voltage.



For agribusiness application.

EN 20345 / EN 50321
CE

Design to prevent clogging.



Non-slip vulcanized rubber.

MV-136 / MV-137

Safety shoes with insulating sole for indoor and dry environment

Shoe with leather and breathable liner microphone.
Anti-perforation textile sole. Protection cap 200J. Adhesion: SRC.
Torsion resistant sole.

Reference	Type	Size	Class	Norme	Use
MV-222-*	Low	39 to 47	0: 1 000V	EN ISO 20345	Industry, construction, bold and smooth floors
MV-223-*	High	39 to 47	0: 1 000V	EN ISO 20345	Industry, construction, bold and smooth floors

* Add size to the reference. Ex: MV-222-43.



MV-222

100 % TESTED 5KV

Ankle protection.



MV-223

Shoes with polyurethane rod and antibacterial lining, ventilated 3D mesh neighborhoods.
Anti-perforation textile sole. Protection cap 200J. Adhesion: SRC.

Reference	Type	Size	Class	Norme	Use
MV-226-*	Low	39 to 47	0: 1 000V	EN ISO 20345	Industry, logistics and transport, services and communities.
MV-227-*	High	39 to 47	0: 1 000V	EN ISO 20345	Industry, logistics and transport, services and communities.

* Add size to the reference. Ex: MV-226-43.



MV-226

Ankle protection.



MV-227

Safety shoes with insulating sole for indoor controlled environment

Low shoes with anti-bacterial and calendared nonwoven lining waterproof leather upper.
Anti-perforation textile sole. Protection cap 200J. Adhesion: SRC.
Torsion resistant sole.

Reference	Size	Class	Norme	Use
MV-228-*	39 to 47	0: 1 000V	EN ISO 20345	Condition of strict hygiene, agribusiness. Controlled environment.

* Add size to the reference. Ex: MV-222-43.



MV-228

MV-227 and MV-228 : on request only.

Insulating mats, make the right choice

In accordance with standards

The insulating mats provide individual and collective protection. Elastomer, they are used to cover the ground for the electrical protection of operators during work or interventions on electrical installations.

In accordance with IEC 61111 
 (Live working tools – insulating mats category C:
 Resistant to very low temperature -40°C)

CHARACTERISTICS OF SYMBOLS



Label with a double triangle symbol IEC 60 417-5216, suitable for live working.

Insulating mats LV class 0

MP-42/16



Insulating mats MV class 3/4

MP-42/11

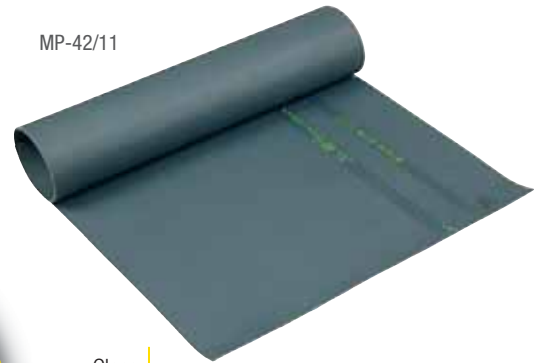

In compliance with IEC 61 111.

Marking IEC or EN.

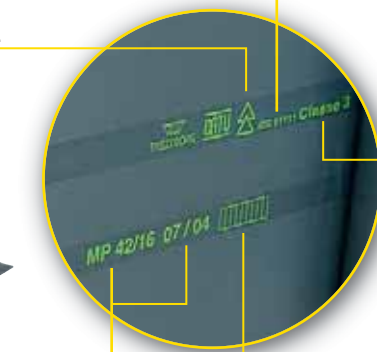



Class.

Traceability.

Marking area showing the date of first use and periodic testing date.

Class and maximum voltage

Class	Voltage 	Voltage 
0	1 000V _{effective}	1 500V
1	7 500V _{effective}	11 250V
2	17 000V _{effective}	25 500V
3	26 500V _{effective}	39 750V
4	36 000V _{effective}	54 000V

Recommendations for use

Storage/Transport

Insulated blanket should be properly stored to avoid the risk of damage to the insulating material.
 Do not bend insulating mats.
 Do not store or use close to excessive heat.
 Do not expose to direct sunlight for long period.
 Storage temperature : 10°C to 21°C.

Before use

Visually inspected by the user. If the insulating mats is dirty, wash it with soap and water. Dry it with respect of using temperatures.

In use

Operating temperatures : -40°C to 55°C.
 Avoid contact with chemical products
 Place the mat on a clean, smooth floor, devoid of aggressive elements for insulation.
 Position the feet in the center of the insulating mat.

Periodic inspection

Insulating mats should not be used without having been electrically tested within twelve month preceding with the exception of class 0. Only visual inspection is required for class 0.







Insulating mats and accessories

IEC 61111 
EN 61111

Insulating mats

Individual models

Reference	Class	Voltage 	Voltage 	Thickness mm	 m	 kg
MP-11/11	0	≤ 1 000 V	≤ 1 500 V	2	1 x 1	2.9
MP-11/16	0	≤ 1 000 V	≤ 1 500 V	2	0.6 X 1	1.4
MP-42/11	3	≤ 26 500 V	≤ 39 750 V	3	1 x 1	4.5
MP-42/16	3	≤ 26 500 V	≤ 39 750 V	3	0.6 x 1	2.9
MP-42/66	3	≤ 26 500 V	≤ 39 750 V	3	0.6 x 0.6	1.8
MP-60/05-1	4	≤ 36 000 V	≤ 54 000 V	5	0.6 X 1	4.4
MP-100/02-10	0	≤ 1 000 V	≤ 1 500 V	2	1 x 10	29



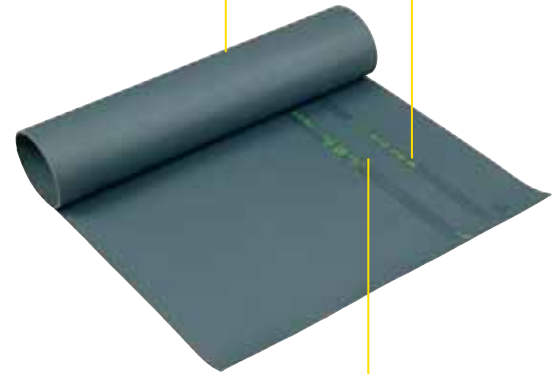

High quality dielectrical rubber.

Regulatory mark clearly indicating the mat features.





Non-skid surface.

For placing in front of panels

Reference	Class	Voltage 	Voltage 	Thickness mm	 m	 kg
MP-60/03-5	3	≤ 26 500 V	≤ 39 750 V	3	0.6 x 5	14
MP-60/03-10	3	≤ 26 500 V	≤ 39 750 V	3	0.6 x 10	28
MP-100/03-5	3	≤ 26 500 V	≤ 39 750 V	3	1 x 5	25
MP-100/03-10	3	≤ 26 500 V	≤ 39 750 V	3	1 x 10	53.5
MP-60/05-5	4	≤ 36 000 V	≤ 54 000 V	5	0.6 x 5	28
MP-60/05-10	4	≤ 36 000 V	≤ 54 000 V	5	0.6 x 10	44
MP-100/05-5	4	≤ 36 000 V	≤ 54 000 V	5	1 x 5	45
MP-100/05-10	4	≤ 36 000 V	≤ 54 000 V	5	1 x 10	89

Insulating mats

Adapted to the **B High Voltage**.

Reference	U max. kV	Thickness mm	 m	 kg
MP-100/10-5	90	10	1 x 5	87
MP-100/10-10	90	10	1 x 10	154

Contact us for any particular application.

High quality dielectrical rubber.



Non-skid surface.

Bags for insulating mats

Specially designed for carrying and protecting insulating mats. Equipped with a shoulder strap.

Reference	Characteristics	
MP-01	For MP-11/16, P-42/16 and MP-42/66	0.7 m
MP-02	For MP-11/11 and MP-42/11	1.1 m



plastic window for instructions and storage identification.



Dimensions



Weight



Total length

Multi-pockets electrician bag

Specially designed for carrying and protecting insulating mats, face shield and controllers.

Reference	mm	g
M-87386	650 x 150 x 250	850
M-87387	690 x 300 x 140	470

Lockable.

Equipped with several pockets.



800 denier dust resistant nylon with PVC coating.

M-87386

Insulating platforms (indoor models)

Reference	Class	Rated insulation	Standards	Height mm	kg
CT-7-25/1	4	≤ 36 kV	UNE 204 001 ≤ 36 kV	220	3.7
CT-7-40/1	5	≤ 45 kV	UNE 204 001 ≤ 45 kV	260	3.8

Moulded insulating material, one-piece.

Top 50 x 50 cm.



Insulating platforms (indoor models)

Adapted to the **B High Voltage**.

Reference	Rated insulation	Height mm	kg
CT-7-63	≤ 63 kV	515	3.35

Removable feet with rubber tips.



Solid plate with moulded insulating material 52 x 52 cm, thickness 40 cm.

Insulating platform (outdoor model)

Reference	Rated insulation	Number of skirts/foot	Height mm	kg
CT-9-25	≤ 24 kV	2	350	6
CT-9-45	≤ 45 kV	3	435	6.5
CT-9-63	≤ 63 kV	4	515	7

Insulating skirts.



Feet with rubber tips.



Arc Flash Protection

the solution for complete electric arc protection

The "Arc Flash" phenomenon.

An electric arc follows a short circuit. It produces nearly instant effects with serious consequences without proper protection.

- The arc's main manifestation is its thermal effect. The heat energy released, which is proportional to the voltage, intensity, and fault length, can be considerable (19.000°C), melting the metal and charring the insulation.
- Blast effect, caused by the very rapid release of energy in a limited volume of air (similar to an explosion).
- Light effect with high ultraviolet and infrared radiation.
- Ionisation effect that can trigger an arc on nearby active sections.

When electric arc danger exists, heat-resistant clothing must be worn.

The arc's characteristics are given by:

- **The resistance value of the free arc, expressed in cal/cm² according to NFPA 70 E, ASTM standards, and IEC 61482-1-1.**

or

- **The protection class (1 or 2) with a constrained arc according to IEC 61482-1-2.**



Fire-retardant clothing in case of exposure to an electric arc, confirming to IEC 61482-2 and the regulation NFPA 70E.

PROTECTION AGAINST ARC FLASH

The following are used to determine the proper equipment for protecting against an electric arc:

- The maximum fault current value.
- The phase/ground rated voltage at the site of the risk.
- The distance between the source of the arc and the reception surface.
- The AC cycle number and the mono or three-phase circuit type.
- The location where the arc is produced (confined space).

After recording these parameters, we can estimate the level of risk and determine the proper protective clothing and PPE to use: **12 to 100 cal/cm² or class 1 or 2.**

For more information, please contact our technical department.



Dimensions



Weight

Nomex III® Undergloves

100% Nomex III® fire-resistant and heat-resistant undergloves. Protects the hands against heat of up to 100°C. Ideal protection for "arc flash" equipment.



EN 407
EN 420

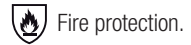

High performance synthetic Nomex III® fibre.

Reference	Characteristics		
CG-37	One size	Includes 5 pairs	32



Test laboratory



for all your mechanical and electrical tests

COFRAC : French Accreditation of Certification



Certificate no. 1-0897
Available at
www.cofrac.fr



ISO 9001 - ISO 14001 - ISO 45001
ORAS 18301 - ISO 16001



Arc Flash equipment

"Arc flash" face shield kit (12 cal/cm²)

Reference	KIT-ARC-01	1.5
Composition	1.5	
MO-187	1 Face shield with chin cup 12 cal/cm ² , absorbs > 99.9% of harmful UV radiation, 70% light transmission, tested to ASTM F 2178 specifications	
MO-182/1-B	1 ABS helmet electrically insulated EN397, EN 50365, ANSI Z89.1 20kV.	
M-87413	1 carrying bag for face shield and helmet	

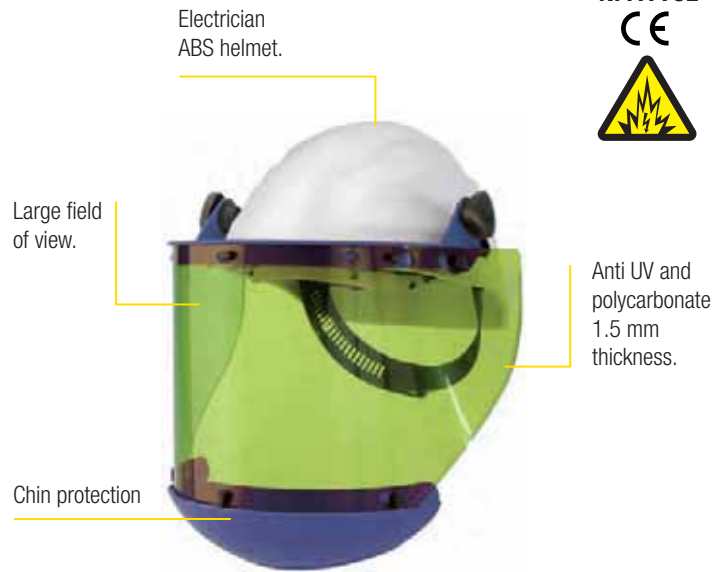

"Arc flash" Helmet (20 cal/cm²)

The only one all integrated helmet with "arc flash" faceshield on the market.

Reference	Characteristics	kg
MO-180-ARC	Integrated helmet with "arc flash" Faceshield	1.2

Retractable Faceshield high visibility & UV Protection. According to NFPA 70E ASTM F 2178 IEC 61482-2 IEC 61482-1-1 IEC 61482-1-2 class 2 GS-ET 29

Mechanical & Electrical Protection helmet EN 397 EN 50365

Light, compact and flexible protection in Arc rated fabric ASTM F1959 ASTM F1506

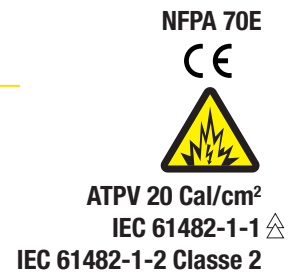

"Arc flash" coverall double zipper

Protects against the thermal hazards of an electric arc. Easy to put on.

Reference	Characteristics	kg
MV-105(*)	Ultra soft	1.4

(*) to complete by size M, L ou XL. Other sizes on request.

Double zipper along the entire length.



"Arc flash" jacket and protective coverall kits (12 cal/cm²)

Reference	Characteristics	Capacity cal/cm ²	kg
KIT-ARC-12-C-(*) *1	Coverall	12 cal/cm ²	4.2
KIT-ARC-12-J-(*) *2	Long hooded jacket	12 cal/cm ²	3
KIT-ARC-12-JP-(*) *3	Short jacket without hood + pants	12 cal/cm ²	4.4

IEC 61482-2 
NFPA 70E

CE



Made of ultra soft® comfortable and light.

Coverall 12 cal/cm².

Composition of KITS

MO-187	1 Face shield with chin cup 12 cal/cm ² , absorbs > 99.9% of harmful UV radiation, tested to ASTM F2178 specifications
MO-182/1-B	1 ABS helmet electrically insulated EN397, EN 50365, ANSI Z89.1, 20kV.
MO-11000	1 safety glasses EN 166/EN 170
MO-134	1 arc flash protective hood (12 cal/cm ²), only with coverall and blue short jacket.
—	1 protective coverall 12 cal/cm ² *1, ASTM F1506 and NFPA 70E Standards or 1 arc flash protective jacket 12 cal/cm ² , ASTM F1506 and NFPA 70E Standards.
M-87413	1 carrying bag for face shield and helmet.
M-87295	1 all kit carrying bag.

(*) Reference to be completed by the size M, L or XL.
Size S to 3 XL on request.

1 For reference KIT-ARC-12-C-()
2 For reference KIT-ARC-12-J-()
3 For reference KIT-ARC-12-JP-()



Blue jacket 3/4 with 12 cal/cm².

Made of Indura ultra soft® comfortable and light.

Protective hood 12 cal/cm².

Safety glasses.

Face shield on electrician helmet

Carrying bag for the kit.



Arc Flash equipment

"Arc flash" protective kits
(25, 40, 65 or 100 cal/cm²)



Reference	Capacity cal/cm ²	kg	Color
KIT-ARC-25-B-(*) *1	25	6	KAKI
KIT-ARC-40-B-(*) *2	40	6.9	GREY
KIT-ARC-65-B-(*) *3	65	8	CAMEL
KIT-ARC-100-B-(*) *4	100	8	CAMEL

Composition of KITS

M-881968 *1 M-881961 *2 M-881976 *3 M-881979 *4	1 arc flash protective hood with an integrated face shield 25 *1, 40 *2, 65 *3 or 100 *4 cal/cm ² , ASTM F2178 and NFPA 70E Standards
MO-182/1-B	1 ABS helmet electrically insulated EN397, EN 50365, ANSI Z89.1 20kV.
—	1 arc flash protective bib overall 25 *1, 40 *2, 65 *3 or 100 *4 cal/cm ² , ASTM F1506 and NFPA 70E Standards
—	1 arc flash protective coat 25 *1, 40 *2, 65 *3 or 100 *4 cal/cm ² , ASTM F1506 and NFPA 70E Standards
MO-11000	1 safety glasses EN 166/EN 170
M-87295	1 all kit carrying bag

(*) Reference to be completed by the size M, L or XL.
Size S to 3 XL on request.

1 For reference KIT-ARC-25-B-()

2 For reference KIT-ARC-40-B-()

3 For reference KIT-ARC-65-B-()

4 For reference KIT-ARC-100-B-()



Safety glasses.

Carrying bag for the kit.

Arc Flash Dungarees, 40 cal/cm².

Arc Flash Jacket, 40 cal/cm².

Arc Flash protective hood with face shield, 40 cal/cm².

Electrician helmet.



KIT-ARC-25-B-(*)

KIT-ARC-40-B-(*)

KIT-ARC-65/100-B-(*)

Workwear and other protections

Electrician coverall

Coverall without metallic part, avoiding any flash hazards.
100% cotton.

Reference	Size for Ref. (*)	Size	Chest size
MV-104/ (*)	00	36/38	76/84
	01	40/42	85/92
	02	44/46	92/100
	03	48/50	101/108
	04	52/54	109/116
	05	56/59	117/124
	06	60/62	125/132
	07	64/66	133/140

(*) Reference to be completed by the size,
ex : MV-104/02.



Other Protection

Work Gloves

Reference	Size	9
CG-96- (*)	A = 8	115
	B = 9	
	C = 10	
	D = 11	
CG-97-C	One size C = 10	115

(*) Reference to be completed by the size of A, B, C or D.

American style gloves with very soft and flexible full bloom leather allowing full finger movement.



EN 388
EN 420

Tightening elastic on the back of the hand.

"Docker" style gloves with very soft full bloom leather allowing full finger movement.



Semirigid red fabric top with elastic on the back.

CG-951 Manutention

Activities: Assembly, fitting, construction, maintenance and all building construction work.

CG-952 Mechanical protection (cutting)

Activities: Packaging, cutting, handling sharp and/or oily objects, stamping, automotive, aerospace, railway work, sharpening, all building and outdoor work.

Reference	Size	Use
CG-951- (*)	7 to 10	Feeding fat and / or humid environment: installation, adjustment, drawing, construction and maintenance, wiring and building work.
CG-952- (*)		

(*) Reference to be completed by the size of 07, 08, 09 or 10.



Knitted glove, 13 gauge, made of cut resistant fibers, elasticated knitwrist, grey, with a black nonslip nitrilfoam coating on palm and fingertips.

Knitted glove, 15 gauge, made of texturized polyamide, black colour, black nitrilfoam coating on palm and fingertips.





Other Protection

Safety Shoes

MV-123

Low, derby style shoe without metal parts.

MV-124

Heavy duty boots without metal parts.

Reference	Size	Marking	kg
MV-123-(*)	from 39 to 48	S3	1.2
MV-124-(*)	from 39 to 48	S3	1.26

(*) Reference to be completed by the size: 39, 40, 41, 42, 43, 44, 45, 46, 47, 48. Example: MV-123-40.



ISO EN 20345
SRC (SRA+SRB)
PPE category 2.



Safety Boots

Exposure to oils, hydrocarbons.

Work involving oil.

Thick soles avoiding, risk of slips and strains.

Heavy duty, manufacturing, and construction.

Reference	Size	kg
MV-131-(*)	from 39 to 47	1.4

(*) Reference to be completed by size: 39, 40, 41, 42, 43, 44, 45, 46, 47. Example: MV-131-40.



S3-SRC
hydrocarbures

Cold Protection Kit and Cap

MO-157

Industrial safety cap with a fabric covered protective shell.

MO-158

Kit to protect against harsh weather conditions, including:

- 1 acrylic helmet cap. Protects against cold inside the helmet.

- 1 yellow high-visibility neck warmer.

Reference	Characteristics	g
MO-157	safety cap	155
MO-158	universal cap	55
	neck warmer	86



EN 812



EN 471



Work at height, a regulation in line with the European Directive.

Regulatory perspective.

The safety equipment for working at height and their methods of use are defined by the decrees:

No. 92-766 dated 29 July 1992: which applies the 1989 European Directive,

No. 2004-924 dated 1st September 2004: "decree relating to the use of work equipment made available for temporary work at height".

The following are defined in these decrees:

The priority is the installation of collective protective equipment. When this is not possible, the use of a device to an item of personal protective equipment against falls from a height is required, whether this is for the purposes of retaining, support, saving, or protecting against falls from a height.

Removal of the minimum height of 3 m: After a risk evaluation, protective equipment is required as soon as there is a risk of a falling.

- The use of access and positioning techniques by means of ropes must comply with the following: a working rope, a safety rope fitted with a fall arrestor system, with two separate anchoring points. Workers must be provided with suitable fall arrestor harnesses connected to both ropes. Safe descent/mounting systems with a self-locking system and a mobile fall prevention system must be provided.

- The work must be programmed and supervised so that assistance can be given immediately to the worker in the event of an emergency.

The workers must receive suitable and specific training in the operations considered and in the rescue procedures.

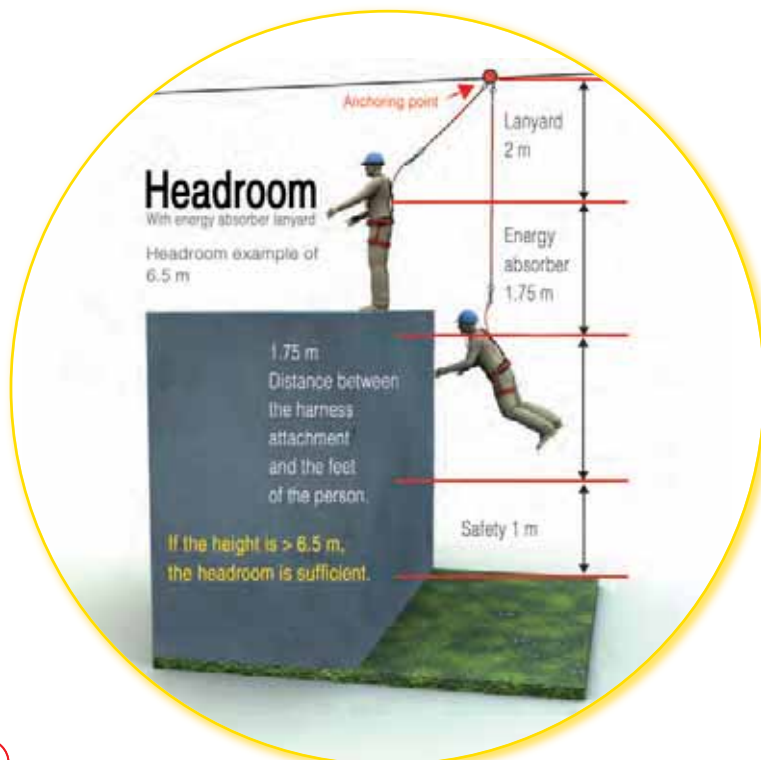

KEY PRODUCT STANDARDS

- EN 353-1.... Fall arrest grab for rigid support.
- EN 353-2.... Fall arrest grab for flexible support.
- EN 354 Restraint lanyard.
- EN 355 Shock absorber lanyard.
- EN 358 Work positioning systems.
- EN 360 Retractable type fall arrestors.
- EN 361 Fall arrest harness.
- EN 362 Connectors.
- EN 363 Fall arrest systems.
- EN 813 Sit harnesses.



To determine your harness size, see the table on 172.



Equipment for working on pole: harness

Pro electric full body fall arrest harness

Reference	Size	kg
MO-565-(*)	S	3
	M	
	XL	

(* Reference to be completed by the size (example: MO-565-M).
Delivered in cloth bag.



EN 358
EN 361
EN 813



Pro electric full body fall arrest harness

Reference	Size	kg
MO-563-(*)	S	2.7
	M	
	XL	

(* Reference to be completed by the size (example: MO-563-XL).
Delivered in cloth bag.



EN 358
EN 361



Full body fall arrest harness

Reference	Size	kg
MO-71	One size	1.9

Delivered in cloth bag.



EN 358
EN 361



Working on pole kits

Reference	Use
KIT-HAUT-01-(*)	To go up a pole with insulating ladders
KIT-HAUT-02-(*)	To go up a pole with spliced ladders
KIT-HAUT-03-(*)	To go up a catenary
KIT-HAUT-04-(*)	To go up on a pylon
KIT-HAUT-05-(*)	To go up on a roof
KIT-HAUT-06-(*)	To go up using a nacelle

(* Add size : M or XL (order example: KIT-HAUT-02-XL).

Composition	KIT-HAUT-...					
	01	02	03	04	05	06
MO-563 : Harness	●	●	●			
MO-565 : Harness				●		
MO-71 : Harness					●	●
MO-52020 : Tether rope	●					●
MO-54010 : Double tether rope		●		●	●	
MO-52034 : Constraint tie	●	●				
MO-52031 : Constraint tie				● x 2		
MO-56009 : Tether rope with Tension device	●	●	●	●	●	
MO-68/15 : Anti-fall grip	●	●	●	●		
MO-54 : Snap hook	●	●				
M-87295 : Carrying bag	●	●	●	●	●	●



Tool bag for safety harness

Reference	mm	g
MO-32/3	250 x 230 x 100	835



Anti-fall grip

“ROP CHUCK” FALL ARREST.

Uses special Ø 15 mm rope exclusively with a spliced upper end.

To be used with a harness.

Reference	Characteristics	kg
MO-68/10	With 10 m of rope	1.6
MO-68/15	With 15 m of rope	2.7

Delivered complete only.

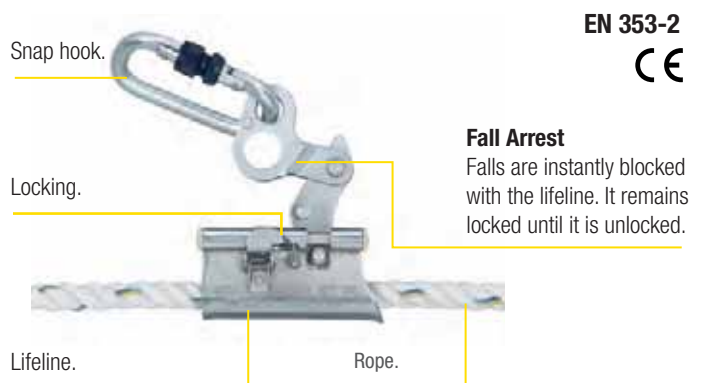

EN 353-2
CE

Fall Arrest

Falls are instantly blocked with the lifeline. It remains locked until it is unlocked.



Equipment for working on pole: anti-fall and tether

Fall arrester retractable type

Reference	Characteristics	
MO-591002	Max. length: 10 m.	5
MO-592002	Max. length: 20 m.	7



Integrated braking mechanism and dissipating element. Self locking mechanism and automatic tensioning and return facility.

Snap hook.

EN 360
CE

Anti-fall device with automatic release strap

Reference	Characteristics	
MO-591000	Anti-fall: 2 m max.	1.16

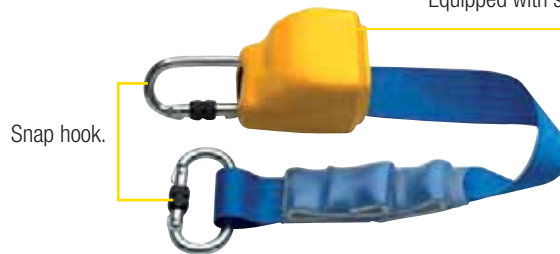

Anti-fall
Winder with self-locking strap. Equipped with shock absorber.

Snap hook.

EN 360
CE

Equipped rope straps with lever stretcher

Reference	Characteristics	
MO-52-L*	Length: 4 m	1 000
MO-61	Stretcher only	450

* Equipped with adjuster.



Hooks to belt with rapid link.

Rope.



EN 358
CE

Protecteur de longe

Reference	Characteristics	
MO-52-P	Chrome leather sleeve	95 cm

Tether rope equipped with a tension device.

Ideal for all horizontal works.

Reference			
MO-56009	2 m	12	750
MO-56010	5 m	12	1 000



Tensioning device: A double-locking system instantly stops the rope.

Polyamid roye.

EN 358
CE

Double tether rope with energy absorber

Reference	↔	↔ after rupture	kg
MO-52020	Length: 1.5 m	3 m	1.1
MO-52021	Length: 2 m	3.5 m	1.2

Equipped with 2 steel snap hooks with automatic locking.

Strap adjuster.

EN 355
CE

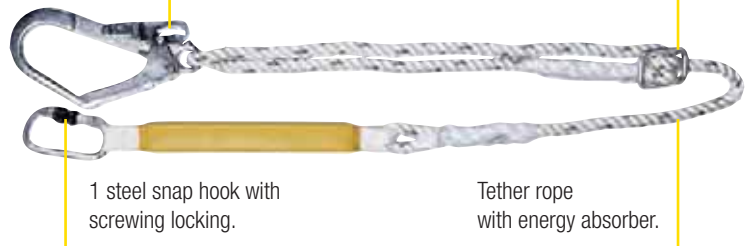

Double tether rope with energy absorber

Reference	↔	↔ after rupture	kg
MO-54010	Length: 1.20 m	3 m	1.4

Equipped with 2 steel snap hooks with automatic locking.

1 steel snap hook with screwing locking.

EN 355
CE

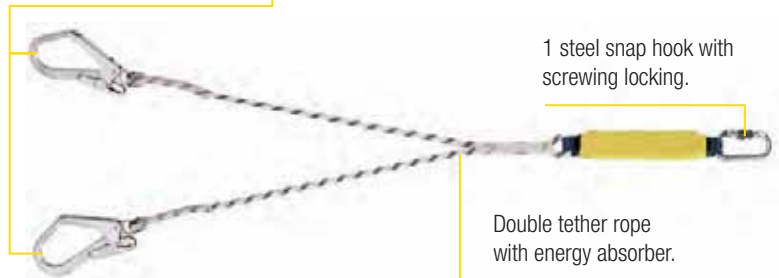

Double lanyard

Can be connected to the harness by locking steel screw karabiners.

Reference	↔	∅ mm	kg
MO-53010	1 m	12	1.4

Double-latch karabiner, 50mm opening.

Two-strand nylon lanyard

EN 354
CE



Mobile safety line

Easy and quick to set up, this line can be used by 2 people. It is equipped with a tension device. This safety line is designed for short operations. The users can then hook themselves to the safety line using a fall arrest device or a shock absorbing lanyard. When using a shock absorbing lanyard, allow for at least 7 meters clearance.

Reference	↔	Resistance	kg
MO-53002	5 to 20 m	1 tonne at each anchor point	2.8

Adjustable strap.

It has 2 harness rings with screw gate karabiners.

EN 795B
CE





Equipment for working on pole: ropes and snap hooks

Safety rope with wear tell tales

Two-colour safety rope, 100% polyester made of 3 white strands with black central thread.

Reference	↔	∅ mm	g
MO-052	4 m	15	760

Buckle: Polyamide central lug attaches to snap-hook of belt.

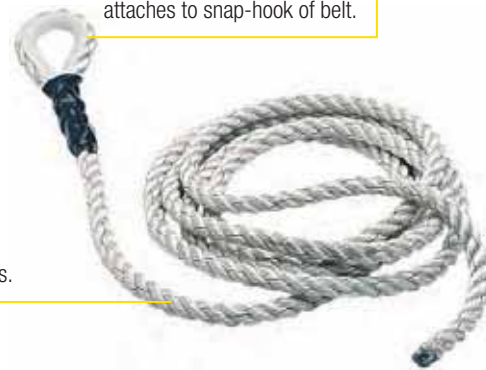

Corde multi-brins.

EN 354
CE

Lanyard

Reference	↔	∅ mm	g
MO-53	1.5 m	10	125

Delivered without snap hook.

Synthetic fibre ropes - 10 mm.



Loops spliced at both ends.

EN 354
CE

Double safety descent device

Double safety manual descent device. Works on a static 11mm lanyard. Its ergonomic shape improves the self-adjusting descent.

Reference	∅ mm	Lanyard	g
MD-02	11		380

High-resistance handle. Anti-panic and anti-faint (auto-locking).



Stainless steel piece.

EN 341-A
CE

Snap hook with double safety latch

Reference	∅ mm	F _{Nm}	g
MO-54002	50	20 kN	390

Body in steel.

Fingers in stainless steel.



EN 362
CE

Equipment for working on pole: snap hooks and anchoring accessories

Snap hooks (stainless steel)

Reference	mm	mm	g
MO-54	18	100 x 58	154
MO-55/1	28	155 x 75	140



Locks with threaded ring.

Additional catch is provided to prevent the rope from slipping in the carabiner.



EN 362
CE

Snap hooks (aluminium alloy) zical

Reference	mm	mm	g
MO-54000	19	110 x 58	78
MO-54004	23	120 x 72	87



D-shaped snap hook with automatic locking.



EN 362
CE

Snap hook with stick adaptor

To fix a life line from the ground. Snap hook to be operated with a stick and unlocking using a cord.

Connector with stick adaptor

Reference	mm	Type	g
MO-54005-C	50	C End fitting	470
MO-54005-K	50	K End fitting	470



Connector for stick. CE-5-90-C.

EN 362
CE

Telescopic stick

Reference	mm	Type	kg
CE-5-90-C	9 m max.	C End fitting	4
CE-5-90-K	9 m max.	K End fitting	4

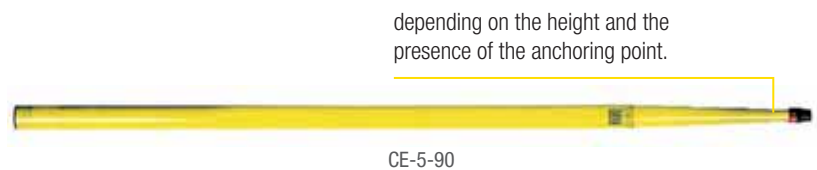

depending on the height and the presence of the anchoring point.

Constraint tie

Reference	mm	g
MO-52031	0.8 m	100
MO-52033	1.20 m	135
MO-52034	1.50 m	150

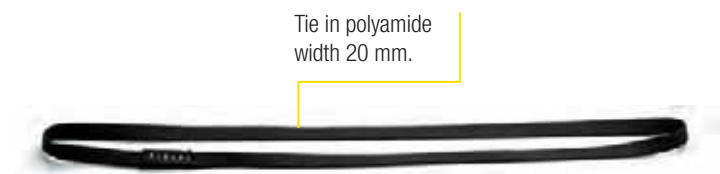

Tie in polyamide width 20 mm.

EN 795
CE



Equipment for working on pole: climbers and accessories

Mechanical climbers for round and hexagonal concrete poles

Reference	∅ Pole mm	kg
MO-16-A	140 > 300	6.5

Delivered by pair.

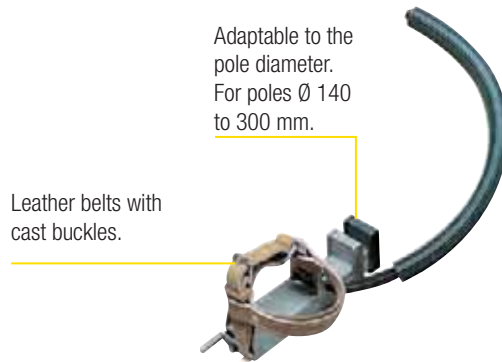

Forged steel climbers for round wooden poles

Reference	∅ Pole mm	kg
MO-24	200	2.6
MO-25	250	2.8
MO-26	300	3
MO-35	350	3.2

Delivered by pair.



NFS-071-012



Climbers for steel beams

Shayed IPN, H ou L.

Reference	mm	kg
MO-23	5 to 20	5.1



Mechanical climbers for rectangular shaped concrete poles

For rectangular shaped concrete poles.

Reference	Pole width mm	kg
MO-17-A	14 to 42 cm	9

Delivered by pair.

Spare parts

Reference	Characteristics
MO-17-01	Pair of elastic cords
MO-17-02	Pair of wear plates
MO-17-03	Blade roller
MO-17-04	Pair of runners

Automatic locking of jaws by elastic cord.

Sole in aluminium alloy, high resistance, with leather belts and steel buckle.

High resistance aluminium alloy rack, used for clamping onto poles 14 to 42 cm wide.

Wear plate placed on sole arm.

Mobile drum on axis can be removed; processed steel rollers.



SECURITY INSULATING LADDERS

Work on or near electrical works and electrical installations maximum voltage of 1000V ac or 1500V dc.

Minutes N° NF 930-03/01/01-29 L.N.E / AFNOR showing compliance with EN-131 and the mark "NF" (Quality Label).

A complete range to high specifications:

- Nominal insulation between 2 bars after immersion in water: 10 000V (EN 50528).
- High mechanical resistance to bending and torsion.
- Good strength / mass.
- Marking of information for use.
- High resistance to weather and corrosive elements and fire.
- The maximum working load 150 daN.

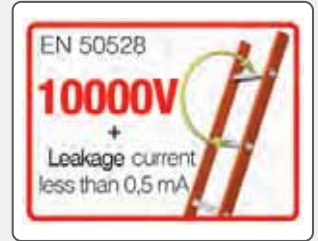

Insulating ladders

Comes with right horizontal stabilizer.

Simple ladders

Reference	↔	Numbers of rungs	kg
MP-602-D	2.41 m	8	6
MP-603-D	2.97 m	10	9
MP-604-D	4.09 m	14	10
MP-605-D	4.93 m	17	12

2 sections extension ladders

Reference	↔ Folded	↔ Deployed	Numbers of rungs	kg
MP-624/2-D	2.41	4.09 m	2 x 8	14.9
MP-634/2-D	2.70	4.65 m	2 x 9	17

Optional accessories:

Cradle support post and front Wheel MP-46503.



EN 131
EN 50528

EN 131
EN 50528

Insulating slide ladders

2 sections extension ladders, hand operated

Reference	↔ Folded	↔ Deployed	Numbers of rungs	kg
MP-514/2	2.41 m	4.09 m	2 x 8	13.9
MP-515/2R	2.97 m	5.21 m	2 x 10	17

2 sections extension ladders, rope and pulley operated

Reference	↔ Folded	↔ Deployed	Numbers of rungs	kg
MP-506/2	3.53 m	6.05 m	2 x 12	22.9
MP-508/2	4.66 m	8.30 m	2 x 16	35.4
MP-509/2	5.22 m	9.14 m	2 x 18	39.3
MP-510/2	5.78 m	10.26 m	2 x 20	43

Ladders come with cradle, strap and front wheels.



Wheels
+ cradle.



Equipment for working on pole: insulating ladders and stepladders

Standard extension ladders

Ladders for electrical work at height.
Maximum load: 150 daN.
Echellons anti-slip aluminum.

2 sections extension ladders,
rope and pulley operated

Reference	Folded	Deployed	Numbers of rungs	kg
MP-607/2-I	4.66 m	8.02 m	2 x 16	30.2
MP-608/2-I	5.22 m	9.14 m	2 x 18	34.4
MP-609/2-I	5.78 m	9.98 m	2 x 20	37.8

3 sections extension ladders,
rope and pulley operated

Reference	Folded	Deployed	Numbers of rungs	kg
MP-607/3-I	2.98 m	6.89 m	3 x 10	24.6
MP-608/3-I	3.82 m	8.86 m	3 x 13	34.6

Optional accessories:
Supports post-straps.



EN 131

Stabilizing compensator ladder

Stabilizer set to low level.
Compensates for differences in height between the two amounts.

Reference	mm	kg
MP-46501	470 x 450 x 140	4.4



Hooves and door insulation kits tools for insulating stool

See page 48.

Reference	mm	g
MP-700-100	150 x 150 x 60	100 *
MP-700-200	280 x 150 x 100	200 **

* Blister.
** Maximum load: 10 kg.



Insulating stepladders

EN 131

Compact stepladders with insulating amounts reinforced polyester fiberglass with light alloy steps to work at height.
 Insulation between two steps: 30 000V
 Maximum load: 150 daN.
 Anti-pinch finger joints.

Reference	Nbr steps	Height Access (m)	Height folded (m)	Height based feet (m)	kg
MP-700-4	3	2.58 m	1.39 m	0.68 m	5.9
MP-700-1	4	2.81 m	1.64 m	0.91 m	6.9
MP-700-2	5	3.04 m	1.89 m	1.14 m	8
MP-700-3	6	3.27 m	2.14 m	1.37 m	9.4
MP-700-5	7	3.50 m	2.39 m	1.60 m	11

Optional accessories:

Replacement kit clogs slip MP 700-100.
 Replacement Kit toolholders MP 700-200.



MP-700-100



MP-700-200



MP-700-2

Folding stepladder with railing

Secure non-insulating platform.
 Maximum working load 150 daN.
 Rung footrest tested 260 daN.

Reference	Nbr steps	Height Access	Height folded	Height based feet	kg
MP-700-6	4	2.93 m	1.48 m	0.93 m	19.5





Work at height : ladders and accessories

Non-slip top ladders

Reference	 mm	 kg
MP-467	105	650

Fixing hinge with screws and wing nut.



Hinged metal disc coated with special non-slip rubber for protection bearing surfaces.

EN 131

Stackable ladders elements



Metallic elements: NF C 18-430.

Upright duralinox.

Insulation elements: IEC-61478 Class I.

Glass-epoxy – non-slip bars,

Orange color T.S.T. - B.t / H.T.A.

Reference	Elements type		Nbr steps	 kg
MP-402-MB	Metallic	2.10 m	7	5.4
MP-403-MB	basic *	3 m	10	7.6
MP-402-MI	Metallic	2.10 m	7	4.8
MP-403-MI	intermedia.	3 m	10	7
MP-501-D	Insulating	1.20 m	4	3.3
MP-502-D	BT / HTA	2.10 m	7	5.8
MP-503-D		3 m	10	8.3

* Telescopic Feet.

Accessories or spare parts

Reference	Characteristics
MP-400	Set of 2 straps without screws
MP-400-2	Cradle replacement

Cradles with straps for attachment to each element.

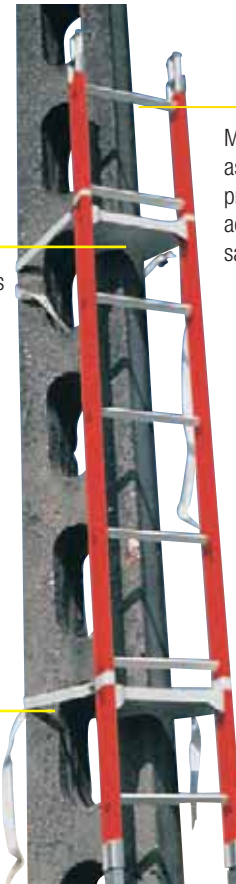

Metallic or insulating elements assembly with ferrules providing truncated pyramid accurate editing, secure and safe blocking.

Telescopic measuring sticks

Measuring sticks for the height of conductors networks. Measurements can be made under tension (under the prescription **UTE 18-510**).

Reference	Characteristics
MO-831	Model BT-HTA - EDF SPS Approval 18-132 A Max. 11 m - Length folded 1.5 m Usable on a 50 kV max. - 3.3 kg
MO-832	Transportation model HTB - Max. 12 m Used on BT, MV and HV systems up to 220 kV Identical to other MO-831 features 2 reeds TST
M-95-236	Measuring gauge diameters (3-20 mm)

8 telescopic sections of insulated polyester glass, graduated and operated by a push-button mechanism.

Upper portion made of IEC 60855 orange reinforced synthetic material.



Direct Reading at the top of the 1st section of the stick, from 2.65 to 11 or 12 m. Graduation in m, dm and cm.



ISOLATION 1kV = ELECTRICAL SAFETY

A range of safety footwear
designed for electricians.



See page 27

MV-223-(*)



MV-222-(*)



MV-226-(*)



MV-227-(*)



MV-228-(*)



Locking



Locking padlocks	52
Multiple lockers	56
Padlock stations	58
Circuit breaker lockers	59
Circuit breaker lockers, panels and insert	60
Fluid locking	61
Lockers	63
Cabinets	64



LOCKING, an essential stage for lockout.

Irrespective of whether servicing or work involves an item of electrical installation or work equipment, a lockout must be done to ensure the safety of the teams working on the job.

Depending on the environments, default lockout accidents are caused by the:

- *Continued presence of live conductor parts for electrical installations.*
- *Presence of pressurized fluids (hydraulic circuits).*
- *Presence of unstable mechanical systems.*

The corresponding recommendations must be applied for each risk, but in all cases specific locking with regard to the risk considered must be set up.

Sometimes the overall analysis of risks reveals a combination of the different risks which makes a more extensive locking operation mandatory. This is especially the case with electricity production equipment.

What does locking mean?

The purpose of locking is to separate cut off or neutralisation parts with a suitable, and sufficiently protected system to prevent any operation by unauthorised persons (switching on power for an electrical installation). Locking is generally accompanied by signs.

For the electrical domain, setting up and removing the lockout are described in national and European standards (EN50110-1).

For electricity production equipment.

More generally, the safety recommendations are included in Directive CE7: 2009/104/EC on the minimum health and safety recommendations for using work equipment.





Locking padlocks

Special models with pictograms

Reference	Shackle		g
	mm	mm	
AL-230-(**)-EX	50	6	204
AL-230-S-(**)-EX	70	6	214
AL-230-Z-EX	50	6	204
AL-230-S-Z-EX	70	6	214
AL-240-(**)-EX	50	4	192
AL-240-S-(**)-EX	70	4	198
AL-240-Z-EX	50	4	192
AL-240-S-Z-EX	70	4	198

(**) Add the key numbers 111 or 222 only.

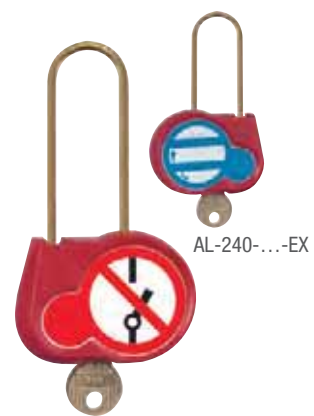

Colour models

Reference	Shackle		Colour	g
	mm	mm		
AL-240-B-111-EX	50	4	○	192
AL-240-B-222-EX	50	4	○	192
AL-240-B-Z-EX	50	4	○	192
AL-240-B-00-EX	50	4	○	192
AL-240-S-B-111-EX	70	4	○	198
AL-240-S-B-222-EX	70	4	○	198
AL-240-S-B-00-EX	70	4	○	198
AL-240-J-111-EX	50	4	●	192
AL-240-J-222-EX	50	4	●	192
AL-240-J-Z-EX	50	4	●	192
AL-240-J-00-EX	50	4	●	192
AL-240-S-J-111-EX	70	4	●	198
AL-240-S-J-222-EX	70	4	●	198
AL-240-S-J-00-EX	70	4	●	198
AL-240-BL-111-EX	50	4	●	192
AL-240-BL-222-EX	50	4	●	192
AL-240-BL-Z-EX	50	4	●	192
AL-240-BL-00-EX	50	4	●	192
AL-240-S-BL-111-EX	70	4	●	198
AL-240-S-BL-222-EX	70	4	●	198
AL-240-S-BL-00-EX	70	4	●	198
AL-240-V-111-EX	50	4	●	192
AL-240-V-222-EX	50	4	●	192
AL-240-V-Z-EX	50	4	●	192
AL-240-V-00-EX	50	4	●	192
AL-240-S-V-111-EX	70	4	●	198
AL-240-S-V-222-EX	70	4	●	198
AL-240-S-V-00-EX	70	4	●	198



Models with insulated shackle

Shackle covered with insulating red PVC.











Reference	Shackle		Colour	g
	mm	mm		
AL-260-(**)-EX	50	6;2	●	200
AL-260-00-EX	50	6.2	●	200
AL-260-Z-EX	50	6.2	●	200
AL-260-S-(**)-EX	70	6.2	●	210
AL-260-S-00-EX	70	6.2	●	210
AL-260-S-Z-EX	70	6.2	●	210

(**) Add the key numbers 111 or 222 only.



Choose your locks!

A complete line of AL padlocks to meet all of your needs

Shackle diameter			Shackle length		Body colours					Keys			Stickers
Ø 6.2 mm	Ø 4 mm	Ø 6 mm	50 mm	70 mm	Red	White	Yellow	Blue	Green	Standard	Random	Upon request	Picto
260	240	230	-	S	-	B	J	BL	V	(*)	Z	00	EX
Isolated ring													
													

To order your padlocks

Bill of material as a reference for your padlocks:

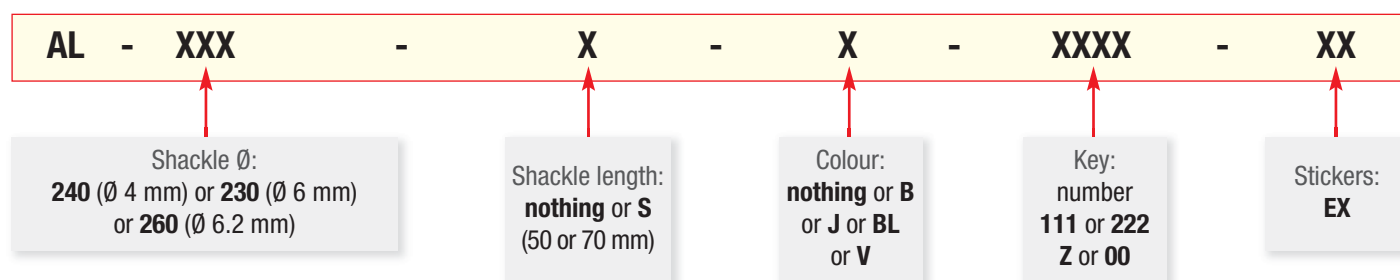

1st example :

Insulated shackle Ø 6.2 mm **AL-260**
 Shackle Lg 50 mm **-**
 Standard colour (red) **-**
 Key n°222 **222**
 Sticker with picto **EX**
 Your reference: **AL-260-222-EX**



2nd example :

Shackle Ø 4 mm **AL-240**
 Shackle Lg 70 mm **S**
 Colour blue **BL**
 Key upon request **00**
 Sticker with picto **EX**
 Your reference: **AL-240-S-BL-00-EX**



Codes or key numbers

(**): Key number 111 or 222.

Z: Number of random key (at random).

00: Key number on request.



⚠ Tables of possible combinations

Key	Sticker	AL-240 (Ø 4 mm)					AL-230 (Ø 6 mm)														
		-(Shackle 50 mm)					-S(Shackle 70 mm)					-(Shackle 50 mm)					-S(Shackle 70 mm)				
		-	B	J	BL	V	-	B	J	BL	V	-	B	J	BL	V	-	B	J	BL	V
(**)		•	•	•	•	•	•	•	•	•	•	•					•				
Z		•	•	•	•	•	•					•					•				
00		•	•	•	•	•	•	•	•	•	•	•					•				

● Existing padlocks.

Key	Sticker	AL-260 (Ø 6.2 mm - insulated shackle)									
		-(Shackle 50 mm)					-S(Shackle 70 mm)				
		-	B	J	BL	V	-	B	J	BL	V
(**)		•	•	•	•	•	•	•	•	•	•
Z		•	•	•	•	•	•				
00		•	•	•	•	•	•	•	•	•	•

● Existing padlocks.



Download our
LOCKOUT/TAGOUT
SOLUTIONS on

www.catuelec.com

Flexible models

Nylon (non-conductive).

Reference	Shackle mm	Lock	Holes mm	mm	g
ALP-03	50	3	9	105	20
ALP-06	80	6	9	183	30



Holds up to 6 padlocks.



Nylon (non-conductive).

All-plastic models

Label with 'DANGER' warning and identification of the person carrying out the work.

Reference	Shackle mm	Lock	Holes mm	mm	g
ALP-4/3	46	3	4	108	35
ALP-4/6	46	6	4	108	35

Nylon (non-conductive).



Holds up to 4 padlocks.



Universal model

Maximum weight supported: 100kg.
'DANGER' warning label.

Reference	Coil	Lock	Holes mm	g
ALP-12/2M	Ø4 Lg 2m	12	9	130

Steel cable coated in non-conductive PVC.





Holds up to 9 padlocks.
Nylon body.



Multiple lockers

Metal models



Reference	 mm	Description	 g
AL-200	100 x 60 x 10	EDF type A	150
AL-202	165 x 50 x 12	EDF type B	200



Holds up to 4 padlocks of Ø 6 mm max (AL-203, AL-230 or AL-240).







Safety padlock

Reference	 mm	Shackle  mm	 g
AL-203 *	6	50	180

* Key n°111.

HASP models

Reference	Clamping  mm		Holes  mm	 mm	 g
ALM-6/25	25	6	9	112	95
ALM-6/38	38	6	9	125	110
ALM-20/45	20 & 31	6	9	138	120







Holds up to 6 padlocks.



Double sided. Holds up to 6 padlocks.

Steel shackle model

Label with 'DANGER' warning and identification of the person carrying out the work.

Reference	Shackle  mm	 mm	Holes  mm	 mm	 g
ALM-6/8	25	5	8	115	80







Holds up to 6 padlocks.



High-strength steel shackle and body.



Yellow PVC handle model

Fitted to the belt so as to free up the hands.
Key ring incorporated into the handle.
Label system ensures that the user knows that all the power sources have been locked out.

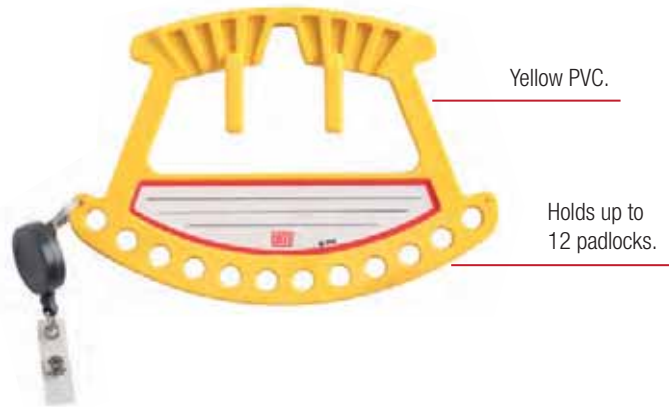
Reference		Holes  mm	 mm	 g
AL-212	12	9	190 x 130	120





Ivory handle model

Reference		Holes  mm	 g
AL-207/30	30	9	130

Ivory white PVC.
High resistance to impacts.



'Lockout manager' model

Reference		 kg
AL-236-111-EX	6 (AL-230-111-EX)	1.15
AL-236-222-EX	6 (AL-230-222-EX)	1.15
AL-236-S-111-EX	6 (AL-230-S-111-EX)	1.21
AL-236-S-222-EX	6 (AL-230-S-222-EX)	1.21
AL-236-00-EX	6 (AL-230-00-EX *)	1.15
AL-236-S-00-EX	6 (AL-230-S-00-EX *)	1.21

* 00: key number on demand.

Compact with transparent cover for key storage.

Plastic handle with 6 padlocks that are all opened with the same key.



Wall support for padlocks

Red-painted metal wall support.

Reference		 mm	 g
RL-100	12	175 x 71 x 31	65







Circuit breaker lockers

Clipblock™ small model

Quick fitting with a no. 3 flat screwdriver.
Highly compact and can be padlocked.
Prohibition sign. Delivered in blister pack.



Reference	Description and 	
AL-201/1	5 units, no padlock	158
AL-201-C/1	Delivered with 1 padlock *	60

* Key on demand.



Multiple model

Suitable for all types of low voltage protection unit locker. Particularly suited to the CLIPBLOCK™ circuit breaker locker.

Reference	Description and 	
AL-205	2 parts delivered with 2m cord. Delivered without padlock or locker AL-201/1.	110
AL-205/5	2 parts - delivered with 5m cord. Delivered without padlock or locker AL-201/1.	160



High resistance plastic cord.
Length 2 m and Ø 4 mm.

ABS body for use with Ø 4 to 6 mm padlocks.



Medium-size models

Red plastic.
No tool needed for installation (tightened manually).
Delivered without padlock.

Reference	Holes Ø mm	Screw	
AL-208-C *	4	Stainless steel	20
AL-208-D **	4	Stainless steel	20

* Bent snipe nose.
** Straight.

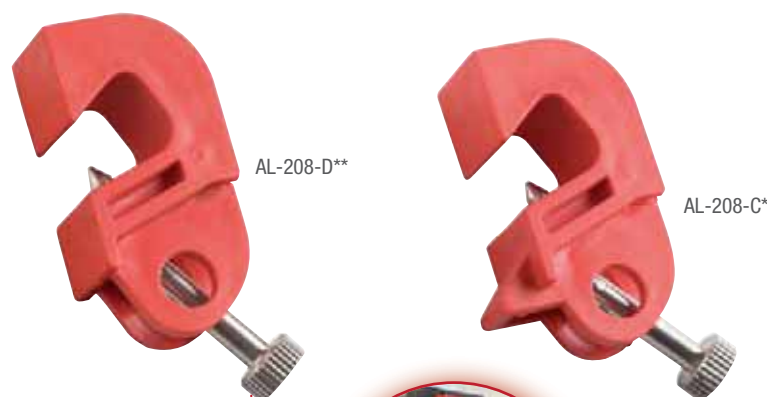





Trip worm to allow space for the padlock shackle.



Large model

No tool needed for installation.

Turn the screw in the circuit breaker handle and add one or more padlocks and a warning label.





Reference		Holes  mm	 mm	
AL-209-L	12	8	76 x 23	66



Holds up to 12 padlocks.

Model for moulded units

Suitable for Schneider circuit breakers with the following references: NS80, NSE75/NSE100, NS100/NS160/NS250, NSF150/NSF250, NS400/NS630, NSJ400/NSJ600.

Reference		Holes  mm	 mm	
AL-204	3	8	37 x 49 x 4 *	32

* Close.



Epoxy painted steel.



Badge models

Ø 10mm hole for attachment on the upper part.

Reference	 mm	Type
AM-467-GB	80	Aluminium
AP-499/1	100	Plastic



AM-467-GB



AP-499/1



Models for gate valves

Polyurethane. Easy to install with the two articulated parts*. Padlock locking. Prevents any handling of the gate valve.

Reference	Holes ∅ mm	Lock	Gate* ∅ mm	Ext. ∅ mm	Weight g
HL-100	6	1	25 to 63,5	70	45
HL-101	8	2	63,5 to 127	140	170
HL-102	9	3	127 to 165	172	250
HL-103	9	3	165 to 254	260	505
HL-104	9	3	254 to 355	370	1055
HL-105	9	1**	25 to 165	-	225

* Except HL-105, 2 parts.
** 4 position settings.



Padlock locking.



HL-105

POLYPROPYLENE
ADJUSTABLE MODEL



Models for 1/4 turn valves

Polyurethane. Easy to adjust with the two clip-in parts. Padlock locking that prevents any quarter turn handling.

Reference	Holes ∅ mm	Lock	Locking	mm	Weight g
HL-200	7	1 ⁸ positions	9.5 to 31.75	195	155
HL-201	7	1 ¹³ positions	38.1 to 63.5	254	230
HL-202	9	1 ¹² positions	50.8 to 203.2	430	580



HL-200

8 adjustment positions.



HL-201

13 adjustment positions.



HL-202

12 adjustment positions.

Universal model

Polypropylene.

For locking all types of valves: 1/4 turn, butterfly, etc.

Reference	Holes mm	Locking	mm	g	
HL-203	9	19 positions	95 to 255	300	285



ADJUSTABLE MODEL

9 adjustment positions.

Gas bottle models

Polystyrene.

Gas bottle locker device (propane, butane, etc.).

Easy to install with the two articulated parts.

Reference	Holes mm	Locking	mm	g	
GL-100	7	1	29	Ø 70	60
GL-101	7	1	35	Ø 85 - L 150	135



GL-101

Padlock locking.



GL-100

Padlock locking.





Electrical or pneumatic socket lockers

Polystyrene. Electrical or pneumatic socket locker device. Easy to install with the two articulated parts. Padlock locking.

Reference	Holes mm	Locks	For cable mm	Dimensions mm	Weight g
PL-100	7	4	13	87 x 50 x 50	75
PL-101	7	4	23	171 x 80 x 80	170



PL-101



PL-100

Holds up to 4 padlocks.

Machine control locker

Red fabric and black leather. Locking device for the control units of numerical machines, cranes, winches, overhead cranes. Padlock locking.

Reference	Holes mm	Locks	Dimensions mm	Weight g
PL-102	11	6	460 x 210	65





Holds up to 6 padlocks.



Lockout cabinet

Two adjustable shelves (12 positions). Locked by key.
 Delivered empty with attachment pegs and screws
 Optional accessories.

Reference	 mm	 kg
SL-101	405 x 355 x 156	5.6



Plexiglas window.

Yellow-painted metal.

Storage cabinet

Locked by key.
 Delivered with 4-level padlock support, attachment
 pegs and screws.
 Optional padlocks.

Reference		 mm	 kg
SL-102	42	465 x 395 x 55	4.5



4 level padlock support.

Red-painted metal.

Plexiglas window.

Signaling



Warning signs

66

Signaling and delineators

69



Warning signs

Special tool steel, oil-hardened.

Reference	Type	mm	Colour
AM-344-GB	aluminium	100 mm side	black letters on yellow
AM-345-GB	aluminium	100 mm side	black letters on yellow
AM-344	aluminium	100 mm side	black & yellow
AM-344/05	aluminium	50 mm side	black & yellow
AM-49/1	aluminium	100 mm side	black & yellow
AM-49/2	aluminium	200 mm side	black & yellow
AM-41/1	aluminium	100 mm side	black & yellow
AM-41/2	aluminium	200 mm side	black & yellow
AM-467-GB	aluminium	Ø 80 mm	white letters on red
AP-499/1	plastic	Ø 100 mm	white & red
AM-20-GB	aluminium	350 x 250 mm	blue letters plain aluminium
AP-510-BT-GB	plastic	297 x 210 mm	golden rules



AM-344-GB



AM-345-GB



AM-344 - AM-344/05



AM-49/...



AM-41/...



AM-467-GB



AP-499/1



AM-20-GB

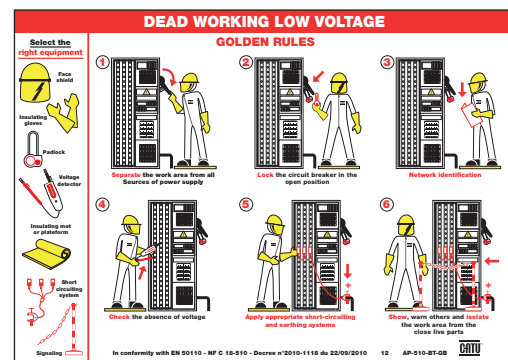

AP-510-BT-GB



Substation signs

Specialist signs.

Reference	Type	mm	Colour
AM-61-GB	aluminium	200 x 150 mm	
AM-61-RM	aluminium	200 x 150 mm	
AM-282/2-RM	aluminium	200 x 60 mm	
AM-7002	aluminium	200 x 300 mm	black & yellow
AM-32/3	aluminium	∅ 300 mm	white & red
AM-33/3	aluminium	∅ 300 mm	red/black on alu
AM-34/2	aluminium	∅ 200 mm	red/black on alu
AP-951/2	plastic	200 x 200 mm	white & red
AP-510-GB	plastic	420 x 297 mm	golden rules
AM-20-RM	aluminium	500 x 350 mm	blue letters on plain aluminium



AM-61-GB



AM-61-RM



AM-282/2-RM



AM-7002



AM-32/3



AM-33/3



AM-34/2



AP-951/2

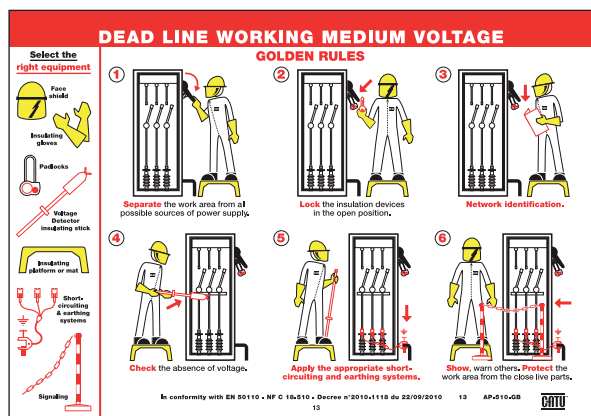

AP-510-GB



AM-20-RM

Self adhesive warning signs

Complete range of self adhesive, warning signs packed in box of 20, 30 or 50 units.



NFX 08-003

Reference	mm	
AT-41/025	25 mm side	50
AT-41/05	50 mm side	30
AT-41/1 *	100 mm side	20
AT-49/025	25 mm side	50
AT-49/05 *	50 mm side	30
AT-49/1 *	100 mm side	20
AT-50/025	25 mm side	50
AT-50/053	50 mm side	30
AT-50/1	100 mm side	20
AT-51/025	25 mm side	50
AT-51/05	50 mm side	30
AT-51/1	100 mm side	20
AT-52/05	50 x 25 mm side	30
AT-52/1	100 x 50 mm side	20
AT-53/05	50 x 25 mm side	30
AT-53/1	100 x 50 mm side	20
AT-54/05	∅ 50 mm	30
AT-54/1	∅ 100 mm	20
AT-55/05	∅ 50 mm	30
AT-55/1	∅ 100 mm	20
AT-56/05	∅ 50 mm	30
AT-56/1	∅ 100 mm	20
AT-58/05	∅ 50 mm	30
AT-58/1	∅ 100 mm	20
AT-59/05	∅ 50 mm	30
AT-59/1	∅ 100 mm	20
AT-60/05	∅ 50 mm	30
AT-60/1	∅ 100 mm	20
AT-61/05	∅ 50 mm	30
AT-61/1	∅ 100 mm	20
AT-62/05	∅ 50 mm	30
AT-62/1	∅ 100 mm	20
AT-63/05	∅ 50 mm	30
AT-63/1	100 mm side	20
AT-66/1	100 mm side	10



* Available in pack of 500,

References : AT-41/1-500, AT-49/1-500 and AT-49/05-500.



Signaling and delineators

Warning flags

Brightly colored ribbon.

Reference	 mm	Fixing
AL-53	350 Width x 650 Height	Fixing on handle.



AL-53

Grounding flags

Vinyl coated fabric.

Reference	 mm	Fixing
AL-58	338 Base x 365 Height	Fixing on handle; for work site 0.75 m
AL-60	338 Base x 365 Height	Fixing on earthing cable; for immediate identification in open-type switchgears possible inscription: 0 to 99 (by using ALU-SCRIPT markers)



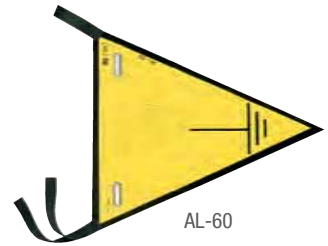

AL-58



AL-60

Safety boundary post

For temporary installation used with tough link chain delineators.

Reference	 mm	Description	 kg
AL-316 *	Length: 90 cm	Red & white	4.2
AL-318 **	Length: 90 cm	Black & yellow	4.2

* Use with chain delineators AL 31/05 and 31/25.
 ** Use with chain delineators AL 32/05 and 32/25.





AL-316

Marker post on a flexible base.



AL-318

Reference	 mm	Description	 kg
AL-321 *	Length: 90 cm	Red & white	0.65
AL-322 **	Length: 90 cm	Black & yellow	0.65
AL-323 *	Length: 90 cm	Red & white	4.5
AL-324 **	Length: 90 cm	Black & yellow	4.5

* Use with chain delineators AL 31/05 and 31/25.
 ** Use with chain delineators AL 32/05 and 32/25.



AL-321

Weighted base.



AL-322



AL-323

Concrete base.



AL-324

Fixing tools for warning signs

Reference	Characteristics
AC-21	Small nickelled chain sold in bags of 10 units.
AD-01	Roundheaded screw anti-vandalism M3x15 sold in bags of 100 units.
AC-44	Self-adhesive plastic plates Ø 40 mm for magnetic fixing (10 units).



Safety adhesive tape

Reference		Description
AT-5005	100 m Lenght x 50 mm Width	Adhesive tape black and yellow.



Textile tape delineators

Reference		Description
AL-127	50 m Lenght x 50 mm Width	Red & yellow
AL-129	50 m Lenght x 50 mm Width	Red & yellow
AL-138	50 m Lenght x 80 mm Width	Red & white





Textile tape delineators

Reference		Description
AL-62-A	20 m Lenght	Red
AL-63-A	x	Yellow
AL-65-A	50 mm Width	Replacement ribbon*



* For AL-62-A.

Chain delineators

Reference		Chain link		Description	
		Ø mm	mm		
AL-31/05	5 m length	8	70 x 27	Red & white	550
AL-31/25	25 m length	8	70 x 27	Red & white	3750
AL-32/05	5 m length	8	70 x 27	Black & yellow	550
AL-32/25	25 m length	8	70 x 27	Black & yellow	3750
AL-31	-	6.5	52 x 30	Set of 10 opening links red & white.	55

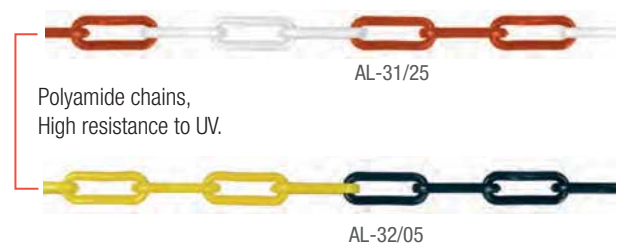

LV test and measurement



<u>Voltage Detector</u>	72
<u>Phase rotation indicator</u>	77
<u>Safety test probes and accessories</u>	78
<u>Installation Controller</u>	80



DETEX™ NG 917-EX and 917/2-EX Voltage Detectors and Testers

IEC 61243-3 
EN 61243-3
CE

The **Detex™** New Generation **MS-917-EX** and **917/2-EX** are designed based on the **IEC 61243-3** standards, in response to the requirements of the **EN 50110-1** European standard.

Sound and lighting equipment, suitable for indoor/ outdoor use. It enables to detect absence of voltage and:

- Checks voltage levels from 12 to 690V AC, 750V DC,
- Sound and light continuity for a non-live circuit (threshold of 200 Ω for 917-EX and 100 Ω for 917/2-EX),
- Unipolar identification of the phase,
- Search for the polarities of a DC circuit,
- Rotary Field by the two-wire method only for 917/2-EX.

Detex™ NG 917-EX

Test-lead points according to IEC 61010-031
Point Ø 2 mm and 19 mm lengths for well contact

Hazardous voltage indicator light (> 50 V).

Phase identification light (unipolar).

DC test button.

Double-insulation flexible cords.



The configuration with both fixed points allows for a 19 mm gap between points, which immediately normalizes the double contact (2P+T, 10/16 A).



SPECIAL FEATURES

917-EX and 917/2-EX

- Fully modularized and adaptable to changing situations.
- Total safety with a light indicating the presence of dangerous voltage (> 50 V).
- A test button to discern the verification of proper functioning from continuity.
- High degree of IP65 and IK06 protection.

917/2-EX

- Equipped with custom lighting.
- Rotary Field check (two-wire method).





Detex™ **NG 917/2-EX**



Lighting unit.

Phase identification light (unipolar).

Phase rotation detection check (two-wire method)

Front panel MS-917-2-EX

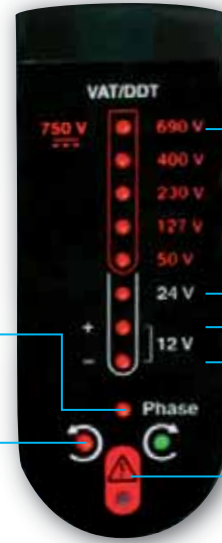

Voltage light. for 24 to 690 V AC (750 DC)

Multifunctional light 12 V / + range 12 V / - range

Hazardous voltage light (> 50 V).

Accessories

Reference	Characteristics
M-87369	Carrying bag *
M-952325	Board hanger *

* Ordered separately.

M-87369 Carrying bag.



MS-917/2-EX storage configuration.



M-952325 Board hanger provided on the back of the device.



Selections and Characteristics:

Reference												
	Voltage 12-690 V AC 12-750 V DC	50/60 Hz +/- 10 %	Continuity	IP65 Protection IK06	Class II	Category IV 600 V	Operations -15 to +45 °C (class N)	2 AAA batteries 1.5 V	Rotary Field	Suitable for standard 2P+T. 19 mm	Lighting unit.	210
MS-917-EX *	•	•	200	•	•	•	•	•	-	•	-	•
MS-917/2-EX *	•	•	100	•	•	•	•	•	•	•	•	•

* Supplied without accessories.

Weight

DETEX™ NG 920-EX Voltage Detector and Tester

IEC 61243-3 
EN 61243-3
CE

The **Detex™** New Generation **MS-920-EX** is designed based on **IEC 61243-3** rates, in response to the requirements of the **EN 50110-1** European standard.

Sound and lighting equipment, suitable for indoor/ outdoor use. It enables to detect absence of voltage and:

- Check of voltage levels > 50 V DC and AC,
- Up to 690 V AC and 500 DC,
- Continuity sound control for a non-live (< 100 Ω),
- Unipolar identification of the phase,
- Search for the polarities of a DC circuit,
- Check (two-wire method).

Detex™ NG 920-EX



Test-lead points according to IEC 61010-031 Point Ø 2 mm and 19 mm lengths for well contact.

Three digit colour LCD screen display.

Test button.

Indicator light when voltage > 50 V.

Double-insulation flexible cords.



SPECIAL FEATURES

- Three-digit digital display **RED** and **BLUE**).
- Measure of AC and DC voltage.
- Fully modularized and adaptable to changing situations.
- Total safety with a light indicating the presence of dangerous voltage (> 50 V).
- A test button to discern the verification of proper functioning and continuity (threshold of 100 Ω).
- High degree of IP65 and IK06 protection.
- Check (two-wire method).
- Equipped with custom lighting.



The configuration with both fixed points allows for a 19 mm gap between points, which immediately normalizes the double contact (2P+T, 10/16 A).



Voltage Detector

MS-920-EX Front Panel Details



Polarity.

Example of continued 24V detection, display is BLUE because < 50 V.



Rotary Field indicator.

Unipolar identification of the phase.

Phase

Hazardous voltage indicator light (> 50 V).

Example of detecting 230 V AC, displayed in RED.



Lighting unit.



M-87369 Carrying bag.



MS-920 storage configuration.



M-952325 Board hanger provided on the back of the device.

Accessories

Reference	Characteristics
M-87369	Carrying bag *
M-952325	Board hanger **

* Ordered separately.
** Included with MS-920-EX.

Selections and characteristics:

Reference													
	Voltage 12-690 AC 12-800 DC	50/60 Hz	Continuity < 100 Ω	Protection IP65 IK06	Class II	Category IV 600 V	-15 to +55°C (class N)	Display 3 digits	2 AAA batteries 1.5 V	Rotary Field	Suitable for standard 2P+T, 19 mm	Lighting unit.	210
MS-920 *	•	•	•	•	•	•	•	•	•	•	•	•	

* Unit comes with a hook table.

No Voltage Tester for electric vehicles

EN 61243-3 (2010) / 
 IEC 61243-3 (2009)
 EN 50110-1
 CE

The **MS-917-VE NVT** voltage tester was specially designed to check for no voltage and direct current voltages on electric or hybrid vehicles.

Used for **No Voltage Checks** and also:

- checking voltage levels from 12 to 700 V DC,
- checking a circuit's sound and light continuity (power off),
- searching for polarity in a DC circuit.

IP2X test-lead points retractable sleeves.
 New: the "Touch" function: hold in the retracted position in complete safety.



Test button and continuity control.













Voltage detection on electrical power circuit.



Do not leave on for more than 30 s.

Selections and characteristics:

Reference												
	Voltage	50/60 Hz +/- 3 %	Continuity	Protection IP65 IK06	Classe II	Category IV 600 V	-15 to +45°C (class N)	2 AAA batteries 1.5V	Phase rotation direction	Suitable for standard 2P+T. 19 mm	Lighting unit.	210
MS-917-VE	12-750 V DC	•	-	•	•	•	•	•	-	•	•	•



IEC 61557-7
CE

Phase rotation indicator

Signaling via the successive lighting of diodes symbolising rotation.
"FAULT" diode lights: phase cut off or incorrectly connected.



Rotate right



Rotate left



Default

Probes with retractable protector with 1.20 flexible cable.

- GREEN - CX-35811.
- YELLOW - CX-45411.
- BROWN - CX-34211.

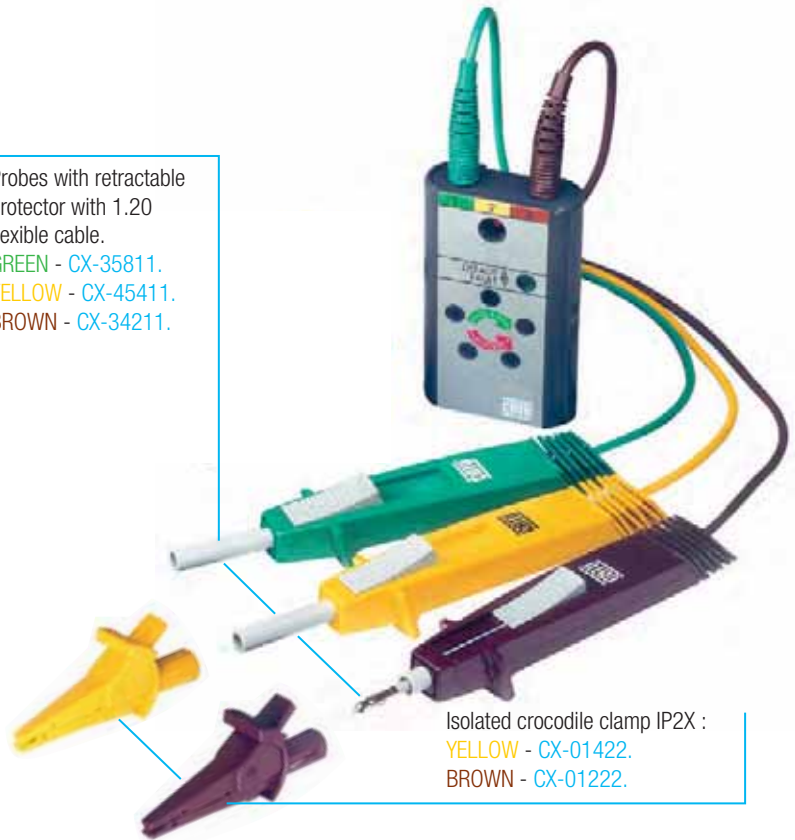

Isolated crocodile clamp IP2X :
YELLOW - CX-01422.
BROWN - CX-01222.



M-87290

Carrying bag with stray.

+ SPECIAL FEATURES

- Compact.
- Visualization by rotation LED's cercle.
- Works on generating units.



Accessories

Reference	Characteristics
M-87290	Carrying bag with stray. (included)



Selections and characteristics:

Reference								
MS-152+ *	Voltage 90-400V	45/60 Hz	Protection IP54 IK06	Class III IEC 61010-1	Phase rotation direction	IP2X test-lead points. IEC 61010-31	225x130x65 = storage	100

* Delivered in storage bag with 3 probes (GREEN, YELLOW, BROWN) 2 crocodile clamps (YELLOW, BROWN).

Voltage take-off punch

The voltage take-off punch is able to make an insulating piercing on a low voltage wire to plug a measurement device.

Reference	 mm	
MS-62	Ø 5.6 - 14.4	15
MS-63	Ø 12 - 31	5

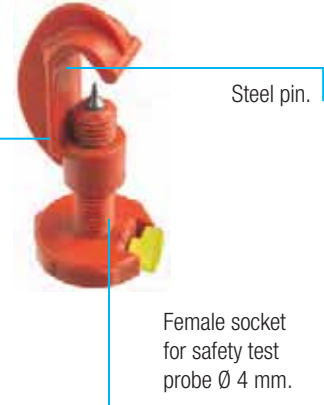

Railways Electrical safety equipment





Safety test probes and accessories

Contact probes for L.V. tester

Lights and rigids contact antennas for **Detex™ NG** :
MS-917-EX, MS-917/2-EX et MS-920-EX.

For overhead lines

Reference	↔	g
MS-8014-2	125 cm	755

Delivered in storage bag 50 x 130 x 1 300 mm.

For installations and sidewalk boxes

Reference	↔	g
MS-8013-2	50 cm	400

Delivered in storage bag 50 x 150 x 470 mm.

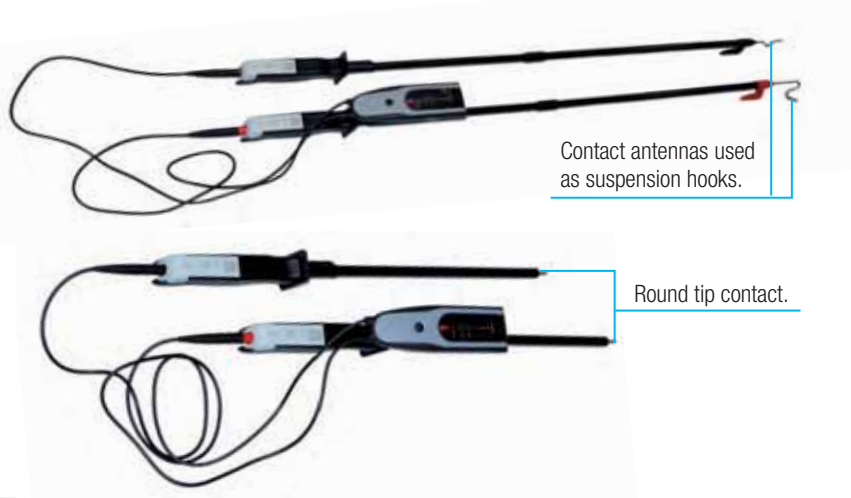

Contact antennas used as suspension hooks.

Round tip contact.

Hand stick

For distance working
2 removables elements

Reference	↔	g
M-951143	80 cm	240
M-952439	extension 40 cm	120

Delivered in storage bag.

Ergonomic handle.

Field of use: 1 000 V max.



Connecting test probe by standard socket.

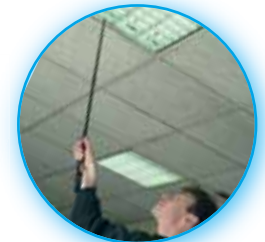

Storage bag

Reference	mm	Characteristics
M-87369	180 x 70 x 45	Storage bag with seatbelt for MS-917, MS-920.
M-87290	225 x 130 x 65	Storage bag with stray for MS-152+ et MS-703.



M-87369

M-87290

Lead set for checks on L.V distribution board

Reference	Characteristics	↔
M-952271	Lead set for checks on L.V distribution board *	80 cm

* For DT-300 and DT-170 only.

Female socket Standard 2P+T.

Heartbring safety crocodile clamp.

Safety test probes with retractables sheath.



M-952271

Storage bag

Reference	mm	Characteristics
M-87292	250 x 200 x 70	Flexible storage bag with handle.



M-87292

Grounding and continuity measurement device CATOHM™ NG DT-300

IEC 61010-1 
IEC 61557-4
CE

CATOHM™ New Generation **DT-300** is designed based on the **IEC 61557-4** standard.

The device measures ground resistance using the "default loop" principle.

The **CATOHM™ NG DT-300** shows the following on its LCD display:

- The presence of voltage and compliance,
- The position of the phase,
- The grounding of the production conductor, the main functions being to measure the ground resistance value and to thus check the continuity of metal masses by sound signal.

Once connected to properly connected installation, the grounding value is instantly measured and displayed at the top of the LCD display, indicating ground resistance values:

- **0 to 100 Ω**, **BLUE** numbers (< the 100 threshold Ω)
- **101 to 1999 Ω**, **RED** digits

The measurement is taken with an accuracy of (+/- 3 % + 1 digit) for pure resistance, ranging 0-200 Ω, at 23°C +/- 5°C.

Uses 2P+T 10/16 A or LV table for single-phase 230V circuits between phases and neutral.



Example measurement without grounding, displayed in **RED**.



Check 2P+T outlet with test-lead point on extension.



Grounding value < 100Ω.

Connection between phases under 400V.

Grounding value > 100Ω.

Accessories

Reference	Characteristics
M-921647	Roller with 7 m of cord *













* To be ordered separately.



SPECIAL FEATURES

- Full autonomy (without battery)
- Use on 2P+T outlet or on LV table with cord.
- LCD display instantly displays the interpretation of measures in terms of their conformity.
- Measures the grounding loop without tripping the breakers: < 15 mA.
- Non-slip coating for a better grip.
- 7 m continuity extension cord.

Features:

Reference												
DT-300 *	230V voltage TT schema	50/60 Hz	Continuity measured at ≤ 2 Ω	400 V voltage present	IP40 Protection IK06	Class II	Category III 600V	Use: -15 °C to +45 °C	4-digit screen display	Grounding < 2000 Ω	71x210x51	340

* Controller delivered with probes and extension on roller.



Insulation controller

IEC 60364 recommends periodically checking **insulation resistance**. Insulation resistance is measured between each active conductor and the ground (when not live). Its value should be **500 kΩ** for a DC testing voltage of **500 V**.

The DT-500 is a specially designed device for quickly, easily, and safely measuring insulation resistance.

It provides a safety system that prevents a measurement when connected to a live installation.

Measures insulation resistance below 500 V.

The insulation resistance value is indicated by illuminating a light:

- **RED** for values including **0, 300, 400 kΩ**.
- **GREEN** for values including **500, 600, 700, 800, 900, 1 000 k and ∞**.



The DT-500 can bypass the phase and neutral in order to protect sensitive equipment (electronics, computers, etc.).



Picture of installation without presence voltage.

Accessories

Reference	Characteristics
M-951981	BLUE probe for replacement *
M-87292	Carrying bag *
M-88896	RED alligator clip for replacement
M-881602	BLUE alligator clip for replacement
M-881601	YELLOW/GREEN alligator clip for replacement

* To be ordered separately.

Features:

Reference	500 V DC	mesures				Use: 15 °C to +45 °C	4 LR6 batteries		213x75x46 mm	600 with batteries and accessories
DT-500 *	Output voltage < 500 V DC	from 0 to ∞	IP54 Protection IK06	Class II	Category III 600V	Use: 15 °C to +45 °C	4 LR6 batteries	IP2X test-end points	213x75x46 mm	600 with batteries and accessories

* Controller delivered with 3 probes, 3 alligators clips and batteries.

IEC 61010-1
IEC 61557-2
CE

500 V test indicator light.

Insulated resistance diodes.

IP2X test-lead point RED.

Battery status indicator light.

Default blinking light.

Test button for measuring and self-testing.

1 m insulation cable.

IP2X test-lead point YELLOW/GREEN (ground).

M-881601

M-88887

M-881602

IP2X test-lead point BLUE (neutral) independent and connected by a safety terminal.

3 large opening alligator clips: RED, YELLOW/ GREEN, BLUE.

The DT-500 comes with a belt clip and areas where test-lead points can be stored.

Ask for your own **LV** Voltage Detector

Detex™

New generation **NG**

The family grows again!

New generation of voltage check (VAT) operations and voltage detectors see page 72.

EN 61243-3 (2010) / 
IEC 61243-3 (2009)
EN 50110-1
CE

MS-917-VE



917-EX



920-EX



www.catuelec.com

LV earthing systems

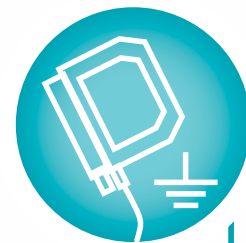

<u>Overhead bare</u>	84
<u>Overhead insulating</u>	86
<u>LV Cabinets</u>	87



Short-circuiting systems

IEC 61230 

Reference	Composition	kg
MT-404	3 MT-411 + 1 MT-411-C	3.4
MT-405	4 MT-411 + 1 MT-411-C	3.8
MT-406	5 MT-411 + 1 MT-411-C	4.2
MT-407	6 MT-411 + 1 MT-411-C	4.6

Icc: 3 kA/1s

Made of 4 references:



Telescopic stik 2 m
CE-2-21-C.

Waterproof bag
MT-400-01.

Earthing equipment for overhead lines systems

Earth rod to be ordered separately.
See below.

Reference	Cable m x mm ²	Earth clamp	kg
MT-242	2 x 16	MT-840/1	1
MT-244	10 x 10	MT-840	2.5
MT-245	10 x 16	MT-840/1	3
MT-249	15 x 16	MT-840/1	3.8

Packaging: polypropylene case.
310 x 280 x 105 mm.

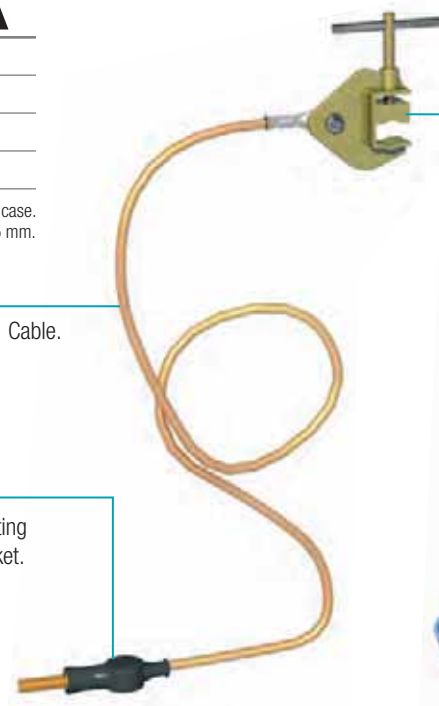

Grounding device connecting with the earth rod
MT-840 MT-650.





IEC 61230

Short-circuiting and earthing systems NEVERS ERDF type

Short-circuit **ERDF** networks

for the work of pruning trees.

Implementation from the ground up to 10.5 m

(sticks + operator) without climbing the support.

Insulating stick contains made of resin polyester/ glass fiber tube diameter 36.

Reference	Composition	kg
MT-509/3	3 Telescopic metallic sticks 3 elements L = 2.37/6.15 m + 1 Telescopic metallic stick 3 elements (latest insulating yellow) L = 2.37/6.15 m + 1 insulating stick 2 elements L = 1.65/3.3 m + 1 multi-strand of 5 cables L = 6 x 16 mm ² with 2 female sockets + 1 stick raise-up + 1 sticks support	19 (3 bags)
MT-509/3EP	1 Telescopic metallic sticks 3 elements L = 2.37/6.15 m + 1 cable L = 6 x 16 mm ² with male socket	2.3
MT-509/3VAT	1 Telescopic metallic sticks 3 elements (latest insulating yellow) L = 2.37/6.15 m	2.5

Equipments packed in carry bags.

Reference	Description	g
CC-127-ERDF-C	Specific voltage detector Range : 127-400 V	450

Accessories

Reference	Description
M952567	Multi strand of 5 copper cables
M952570	Insulating sticks support
MT-546	Insulating sticks raise up
M611386	Raise up sticks
M952568	Earth cable

Voltage detector
CC-127-ERDF-C.



Earth cable
M952568.



Multi strand of
5 copper cables
M952567.



Insulating sticks
raise up MT-546.



Insulating sticks
support M952570.



Insulating sticks Nevers type.

Insulating sticks.



Insulating sticks bag.



Lowlock system

For conductors 3 to 21 mm Ø.

With clamps type "snap-on/screw-on".

Connecting cables: 35 mm² copper.

Short-circuiting and earthing systems

Reference	Rating	Composition	
MT-615/1-7.5	7.5	5 MT-616/1-03 contact clamps on handles (l = 0.35 m each) 4 braids of M-24-35 copper cable (1.00 m) 1 M-87-153 carrying bag 250 x 85 x 750 mm	3
MT-615/2-7.5	7.5	5 MT-616/1-03 contact clamps on handles 4 braids of M-24-35 copper cable (1.00 m) 1 braid of M-24-35 copper cable (7.00 m) 1 MT-840/1 earth clamp	6.5

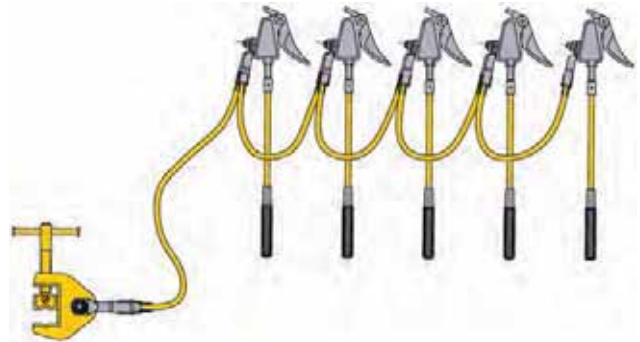

Short-circuiting systems

Equipment includes either 5 or 6 copper-aluminium alloy stubs

Reference	Socket	
MT-205	5	1.1
MT-206	6	1.5
MT-207	7	1.9

Packaging: polypropylene case.
234 x 215 x 75 mm.

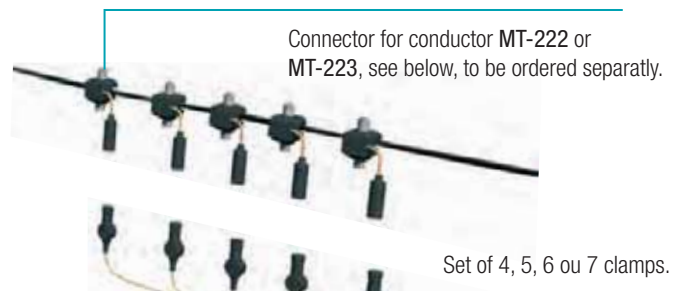
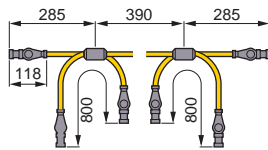

icc: 4 kA/1s



An extra-flexible 16 mm² copper cable assembly.

Connectors for conductors

Reference	 m x mm ²
MT-222	16 x 25
MT-223	35 x 70

Upon request, ability to connect with a male socket.

MT-222



Earthing equipment

Earth rod

Earthing equipment with bayonet splicing for overhead lines systems.

Reference		
MT-650	1 m	2.2

To be ordered in addition to short circuit and grounding equipment.

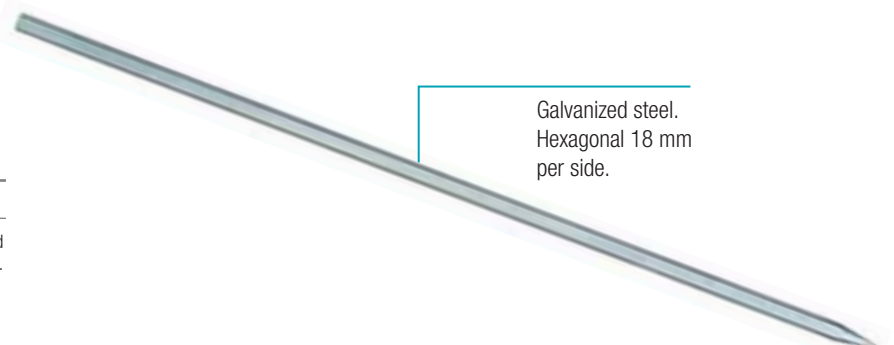

Galvanized steel.
Hexagonal 18 mm per side.



Short circuiting device for LV cabinet

The ground works BT is a mandatory operation in the NFC 18510 (chp 7.1 - Processes log) standard. Tinned copper insulated cable silicone core 16 mm². Authorized employment ERDF equipment.

Composition A: for connection.

Composition B: for network.

Composition C: for connection and network.

Maximum Icc : 4kA/1s.

IEC 61230



Composition set	Reference	MC-296-A	MC-296-B	MC-296-C
4 multi-strand copper cables 16mm ²	MC-296-440	1		
4 multi-strand copper cables 16mm ²	MC-296-560		1	1
5 multi-strand copper cables 16mm ²	M-952656		1	1
Micro clamps	MC-296-P*	1	1	1 + 1 clamp
Connecting blade	M-95627/4*	1		1
Round cartridge	M-95626/4*	1		1
Cartridge size 00	MC-296-00/08*	1		1
Cartridge size 115	MC-296-115/08*		1	1
Cartridge size 160	MC-296-160/08*		1	1
Threaded adapters	MC-181*		1	1
Pipe wrench 10x17mm	M-882462		1	1
Open end spanners 13/14/16/17	MO-687-D	1	1	1
Handle	MC-296-M	1	1	1
Case with foam and notice	M-91209	1	1	1



* Sold in packs of 4. Other composition on request.

Intervention:

Case CIBE/REMBT/C400 P200/CODI/TUR/TIPI/False grid cutoff and riser.

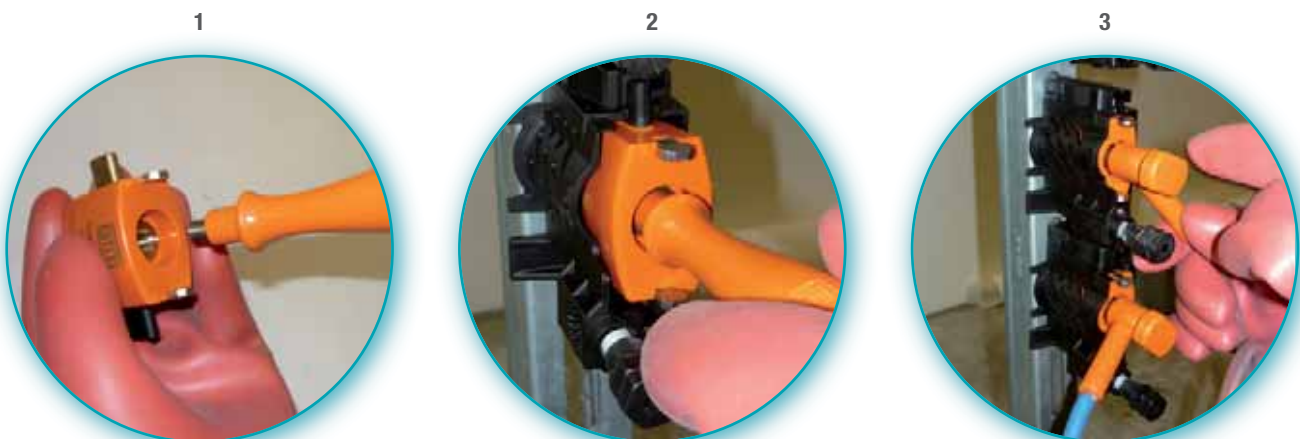

Short circuiting device for LV industries cabinet

IEC 61230 

The earthing BT works is a mandatory operation in the NFC 18510 (- Processes log chp 7.1) standard.
Multi strand isolated copper silicon cable 16mm².

Composition set	Reference	MC-296-NFC
5 Multi-strand copper cables 16mm ²	M-952650	1
Micro clamps	MC-296-P*	1 + 1 clamp
Case and notice	M-76768	1

* Sold in packs of 4.



Threaded adapter

Smooth threaded terminals for positioning shunts (live working tools) or earthing equipment and short circuit cabinets terminals LV.

Reference	Description	Composition	
MC-184-6F	Smooth threaded terminal M6	Set of 4 adapters by reference, delivered in a vinyl bag	120
MC-182	Smooth threaded terminal M8	Set of 4 adapters by reference, delivered in a vinyl bag	150
MC-185-10F	Smooth threaded terminal M10	Set of 4 adapters by reference, delivered in a vinyl bag	200
MC-183	Smooth threaded terminal M12	Set of 4 adapters by reference, delivered in a vinyl bag	250



Reference	Description	Composition	
MC-184-6M	Smooth bolt terminal M6	Set of 4 adapters by reference, delivered in a vinyl bag	120
MC-182-8M	Smooth bolt terminal M8	Set of 4 adapters by reference, delivered in a vinyl bag	150
MC-185-10M	Smooth bolt terminal M10	Set of 4 adapters by reference, delivered in a vinyl bag	200
MC-181	Smooth bolt terminal M12	Set of 4 adapters by reference, delivered in a vinyl bag	250



LV Live working tools

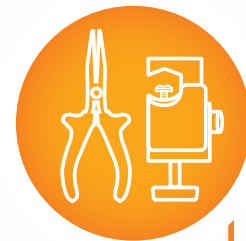

<u>Insulated tools</u>	90
<u>Jumper clamps, cables and accessories</u>	115
<u>Cover-up equipment</u>	118
<u>Cable identifier</u>	122



Insulated Tools

Find the tools to meet your needs!

Insulated tools must comply with the **NF EN 60900** and **IEC 60900** standards. To meet these standards, insulated tools undergo 10 000 volts through electrical testing and many mechanical tests, including impact tests, tearing tests, and puncture tests. For working live at nominal voltage up to 1000 V a.c and 1500 V d.c.

IEC 60900 2012

ISOMIL™
SAFETY TOOLS

1000 V
IEC60900 EN60900

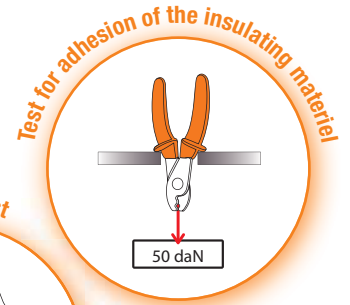
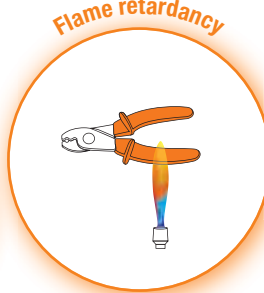
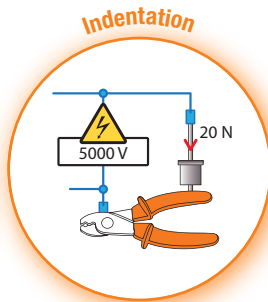
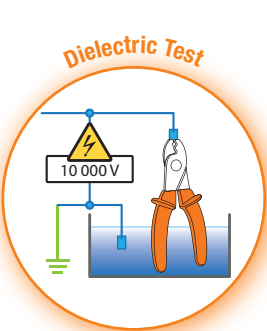

Dual Material Insulated Tools



Dual Layer Insulated Tools



+ SPECIAL FEATURES

- Products suitable for work on live cables, particularly low voltage (30 cm area of a live bare wire).
- Ergonomic.
- Dual material with non-skid "SOFTGRIP"® injected material for operator comfort.

+ SPECIAL FEATURES





- Extensive product line for work on live cables; mainly used by LV Live Line Working teams.
- Ergonomic.
- Dual-layer with a white insulating layer.
- High mechanical strength in the layers due to dipping technique.
- Steel with high mechanical properties.

Routine test: each tool is tested at 10kV for ten seconds.



Insulated tools



Flat blade screwdriver, dual material

Reference	 mm	 mm	 g	
MO-72002	2.5	60	30	
MO-72003	3	100	40	
MO-72004	4	125	50	
MO-72005	5	150	70	
MO-72006	6	150	90	
MO-72008	8	175	150	
MO-72010	10	200	220	

IEC 60900 



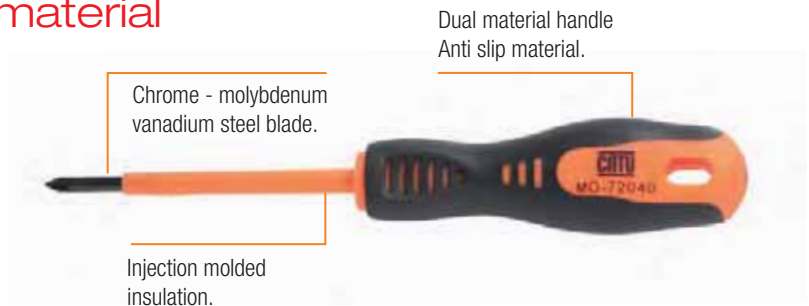

POZIDRIV screwdriver, dual material

Reference	PZ N°	 mm	 g	
MO-72040	PZ 0	60	25	
MO-72042	PZ 1	100	60	
MO-72044	PZ 2	125	90	
MO-72046	PZ 3	150	150	
MO-72048	PZ 4	200	220	





PHILLIPS screwdriver, dual material

Reference	PH N°	 mm	 g	
MO-72030	PH 0	60	25	
MO-72032	PH 1	100	60	
MO-72034	PH 2	125	90	
MO-72036	PH 3	150	150	
MO-72038	PH 4	200	220	





TORX screwdriver, dual material

Reference	N°	 mm	 g	
MO-72056	T 6	50	25	
MO-72057	T 7	50	25	
MO-72058	T 8	50	25	
MO-72059	T 9	75	35	
MO-720510	T 10	75	35	
MO-720515	T 15	75	50	
MO-720520	T 20	100	70	
MO-720525	T 25	100	80	
MO-720527	T 27	115	90	
MO-720530	T 30	125	100	
MO-720540	T 40	125	120	
MO-720545	T 45	150	160	
MO-720550	T 50	175	200	



Hexagonal screwdriver ALLEN, dual material

IEC 60900 

Reference	On flats (mm)	 mm	 g	
MO-68402	2.5	75	40	
MO-68403	3	75	50	
MO-68404	4	100	70	
MO-68405	5	100	80	
MO-68406	6	125	100	
MO-68408	8	150	150	







Cable cutter plier, dual material

Reference	 mm	 mm Cu / Al	 g	
MO-72200	160	Ø 5 max	238	









Wire stripping plier, dual material

Reference	 mm	 mm Cu / Al	 g	
MO-72172	160	0.5 to 10 mm ²	170	



Universal plier, dual material

Reference	 mm	 mm	 mm	 mm	 g	
MO-72102	180	Ø 3.5	Ø 2.2	Ø 1.5	280	

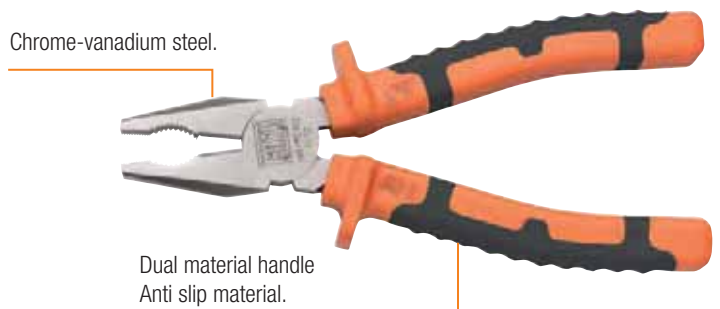



Insulated tools

Flat nose plier, dual material

Reference	mm	mm	g		
MO-72132	160	170			

Chrome-vanadium steel.



IEC 60900

Dual material handle
Anti slip material.

Bent snipe nose plier, dual material

Reference	mm	mm			g	
MO-72142	160	∅ 2.5	∅ 1.6	∅ 1	170	

Chrome-vanadium steel.



Dual material handle
Anti slip material.

Round nose plier, dual material

Reference	mm	g		
MO-72122	160	160		

Chrome-vanadium steel.



Dual material handle
Anti slip material.

Water pump plier, dual material

Reference	mm	mm	g	
MO-72155	250	32	350	

Double rack slipt joint.

Chrome-vanadium steel.



Dual material handle
Anti slip material.

Side cutter plier, dual material

Reference	mm	mm			g	
MO-72162	160	∅ 3	∅ 2.2	∅ 1.5	210	

Chrome-vanadium steel.



Dual material handle
Anti slip material.

Screwdrivers kit, dual material

IEC 60900 

Reference	KIT-23
Composition	
MO-72004	Flat blade screwdriver de 4 x 125 mm
MO-72006	Flat blade screwdriver 6 x 150 mm
MO-72008	Flat blade screwdriver 8 x 175 mm
MO-72042	POZIDRIV screwdriver N°1
MO-72044	POZIDRIV screwdriver N°2



Pliers kit, dual material

Reference	KIT-27
Composition	
MO-72102	Universal plier 180 mm
MO-72155	Water pump plier 250 mm
MO-72172	Wire stripping plier 160 mm
MO-72142	Bent snipe nose plier 160 mm
MO-72200	Cable cutter 160 mm



Intervention kit, dual material

Reference	KIT-24
Composition	
MO-72004	Flat blade screwdriver 4 x 125 mm
MO-72006	Flat blade screwdriver 6 x 150 mm
MO-72008	Flat blade screwdriver 8 x 175 mm
MO-72042	POZIDRIV screwdriver N°1
MO-72044	POZIDRIV screwdriver N°2
MO-72172	Wire stripping plier 160 mm
MO-72142	Bent snipe nose plier 160 mm
MO-72200	Cable cutter 160 mm



Complete intervention kit, dual material

Reference	KIT-25
Composition	
MO-72004	Flat blade screwdriver 4 x 125 mm
MO-72006	Flat blade screwdriver 6 x 150 mm
MO-72008	Flat blade screwdriver 8 x 175 mm
MO-72042	POZIDRIV screwdriver N°1
MO-72044	POZIDRIV screwdriver N°2
MO-72102	Universal plier 180 mm
MO-72155	Water pump plier 250 mm
MO-72172	Wire stripping plier 160 mm
MO-72142	Bent snipe nose plier 160 mm
MO-72200	Cable cutter 160 mm





IEC 60900 ⚡

Screwdrivers kit dual material







Photos of KIT-23SCP

	KIT-23C	KIT-23S	KIT-23SC2	KIT-23SH	KIT-23P	KIT-23SP2	KIT-23SCP	KIT-23CH	KIT-23PH
MO-72003 flat blade screwdriver 3 x 100		•	•	•		•	•		
MO-72004 flat blade screwdriver 4 x 125		•	•	•		•			
MO-72005 flat blade screwdriver 5 x 150		•	•	•		•	•		
MO-72006 flat blade screwdriver 6 x 150		•	•			•			
MO-72008 flat blade screwdriver 8 x 175		•							
MO-72030 screwdriver PH 0 x 60	•								
MO-72032 screwdriver PH 1 x 100	•		•				•	•	
MO-72034 screwdriver PH 2 x 125	•		•				•	•	
MO-72036 screwdriver PH 3 x 150	•							•	
MO-72040 screwdriver PZ 0 x 60					•				
MO-72042 screwdriver PZ 1 x 100					•	•	•		•
MO-72044 screwdriver PZ 2 x 125					•	•	•		•
MO-72046 screwdriver PZ 3 x 150					•				•
MO-68403 hexagonal screwdriver 3 x 75				•				•	•
MO-68404 hexagonal screwdriver 4 x 100				•				•	•
MO-68404 hexagonal screwdriver 5 x 100				•				•	•

Delivered under blister.

Flat blade screwdriver





IEC 60900 

Reference	 mm	 mm	 g	
MO-65202	6.5	40	38	
MO-65203	3	100	33	
MO-65204	3.5	100	37	
MO-65205	4	100	46	
MO-65206	5.5	125	75	
MO-65207	6.5	150	94	
MO-65209	8	175	165	
MO-65211	10	200	195	
MO-650-D	Set of 3 screwdrivers MO-65205 / MO-65207 / MO-65209			
MO-652-D	Set of 4 screwdrivers MO-65203 / MO-65205 / MO-65207 / MO-65209			

Chrome - molybdenum
vanadium steel blade.





Flat blade screwdriver with recessed blade

Reference	 mm	 mm	 g	
MO-65200D	6.5	40	36	
MO-65202D	2	70	16	
MO-65203D	3	100	30	
MO-65204D	4	120	52	
MO-65205D	5.5	100	50	
MO-652055D	5.5	150	72	
MO-65206D	6.5	150	36	
MO-65208D	8	150	92	
MO-652082D	8	200	142	
MO-65210D	10	150	166	
MO-652102D	10	250	282	
MO-65212D	12	250	318	

Chrome - molybdenum
vanadium steel blade.







PHILLIPS screwdriver

Reference	PH N°	 mm	 g	
MO-65230	PH 0	60	25	
MO-65232	PH 1	80	50	
MO-65234	PH 2	100	75	
MO-65236	PH 3	150	150	
MO-65238	PH 4	200	230	
MO-653-D	Set of 3 screwdrivers N°0, N°2 et N°3			

Chrome - molybdenum
vanadium steel blade.



PHILLIPS screwdriver with recessed blade

Reference	 mm	 mm	 g	
MO-65232D	PH 0 (4)	75	50	
MO-652321D	PH 0 (4)	150	55	
MO-65233D	PH 1 (5)	100	60	
MO-65234D	PH 2 (6)	125	82	
MO-65236D	PH 3 (8)	150	146	
MO-65238D	PH 4 (10)	200	256	

Chrome - molybdenum
vanadium steel blade.





IEC 60900

POZIDRIV screwdriver

Reference	PZ N°	mm	g
MO-65240	PZ 0	60	25
MO-65242	PZ 1	80	50
MO-65244	PZ 2	100	75
MO-65246	PZ 3	150	150
MO-65248	PZ 4	200	230



POZIDRIV screwdriver with recessed blade

Reference	mm	mm	g
MO-652405D	5	40	34
MO-652406D	6	40	34
MO-65244D	PZ 0 (4)	75	50
MO-652441D	PZ 0 (4)	150	55
MO-65245D	PZ 1 (5)	100	60
MO-65246D	PZ 2 (6)	125	82
MO-65248D	PZ 3 (8)	150	146
MO-652410D	PZ 4 (10)	200	256



Screwdriver block terminal flat/PHILLIPS

Reference	mm	mm	
MO-65405	5	80	
MO-65406	6	100	



Screwdriver block terminal flat/POZIDRIV

Reference	mm	mm	
MO-65505	5	80	
MO-65506	6	100	



For fuse boxes, connecting boxes, circuit breaker terminal blocks.

Universal plier

Reference	mm	g	
MO-66001	160	210	
MO-66002	180	260	
MO-66003	200	300	
MO-66005	250	510	



MO-66002

IEC 60900

Special steel,
oil-hardened.
Burnished head.



MO-66005

Flat nose plier

Reference	mm	g	
MO-66300	145	115	
MO-66301	160	160	
MO-66302	170	180	



Chrome-vanadium
steel.

Bent snipe nose plier

Reference	mm	g	
MO-66402	160	160	
MO-66404	200	185	



Chrome-vanadium
steel.

Round nose plier

Reference	mm	g	
MO-66202	160	150	



Chrome-vanadium
steel.

Long nose plier with side cutter

Reference	mm	g	
MO-66102	160	145	



Chrome-vanadium
steel.

Plug plier for preinsulating pin terminals

Reference	mm	g	
MO-66105	200	200	



Chrome-vanadium
steel for pin
terminals 2.8/5/6.35 mm.



Insulated tools

Insulating universal plier

Reference	mm	mm	g	
MO-66000C	200	16 mm ² copper	170	



IEC 60900

Composite insulation.

Insulating flat nose plier

Reference	mm	mm	g	
MO-66303C	190	16 mm ² copper	110	



Composite insulation.

Insulating bent half round nose plier

Reference	mm	mm	g	
MO-66404CC	210	16 mm ² copper	110	



Composite insulation.

Waterpump plier

Reference	mm	mm	g	
MO-66502	250	33	250	
MO-66505	250	33	405	
MO-66500	410	45	1 000	

Chrome-vanadium steel.



Double rack slip joint (MO-66505 only).

End cutting pliers

Reference	mm	mm	g	
MO-67401	140	∅ 2 max ∅ 1 max	165	
MO-67402	160	∅ 3 max ∅ 2 max	210	
MO-67404	200	∅ 4 max ∅ 3 max	450	

Chrome-vanadium steel.



MO-67402



MO-67404





Total length Maximal opening Cutting capacity

Weight

Steel: 75 daN / mm² Steel: 180 daN / mm² Steel: 220 daN / mm²

Diagonal cutting plier

IEC 60900 

Reference	 mm	 mm	 mm	 mm	 g
MO-67101	140	∅ 2	∅ 1	∅ 0.5	150
MO-67102	160	∅ 3	∅ 2.2	∅ 1.5	180
MO-67103	190	∅ 3.2	∅ 2.5	∅ 2	210

Chrome-vanadium steel.



Chrome-vanadium steel.



Cable cutter

Reference	 mm	 mm	 g
MO-67500	180	∅ 5 Cu / Al	420





MO-67501

Chrome-vanadium steel.







MO-67502

Cable cutter

Reference	 mm	 mm	 g
MO-67501	170	∅ 15 max	285
MO-67502	230	∅ 20 max	520

Cable cutter

Reference	 mm	 mm	 mm	 g
MO-67700	590	30	185 mm ² Copper/ Aluminium	2.5
MO-67701	765	20	∅ 12 Aluminium	2.8

Chrome-vanadium steel.



MO-67700



MO-67701



Insulated tools

Wire stripping plier

Reference	mm	mm Stripping capacity mm ²	g
MO-67302	160	0.5 to 10	170

Chrome-vanadium steel.



IEC 60900

Wire stripping plier fully insulated

Reference	mm	mm Stripping capacity mm ²	g
MO-67302C	260	0.5 to 10	175



Stripping tool for LV cables

Reference	mm	mm Stripping capacity	g
MO-67304	220	Ø 8 to 21 mm	470



Aluminium casting plier.

Stripping tool for LV cables

Reference	mm	mm Stripping capacity	g
MO-67305	265	Ø 21 to 35 mm	650
MO-67306	270	Ø 26 to 52 mm	670



Aluminium casting plier.

Insulated knife

Reference	mm	mm	g
MO-61001	180	62	110
MO-61002	180	50	110

Delivered with pouch.

Curved blade.





MO-61001



MO-61002

Ratchet cable cutter

Reference	mm	 mm Copper section mm ²	Aluminium section mm ²	 g
MO-67599	Ø 32 max	180	250	900
MO-67600	Ø 38 max	240	300	950
MO-67601	Ø 55 max	300	450	975



IEC 60900 



MO-67599

Treated forged steel blade.



MO-67600



Frontal ratchet cable cutter

Reference	mm	 mm Copper section mm ²	Aluminium section mm ²	 g
MO-67611	Ø 32 max	180	250	900



Treated forged steel blade.

Hacksaw

Reference	 mm	 mm	 g
MO-64501	263	130	150
MO-64502*	450	300	780

* Delivered with 2 blades.

Protected hard forged steel.



MO-64502

Two blade positions.
Flush and 90° cutting supplied.

Tension blade
by screw.





MO-64501





IEC 60900 ⚡

Adjustable spanner

Reference	 mm	 mm	 g
MO-69002	210	24 max	295
MO-69003	250	28 max	450
MO-69004	310	34 max	550
MO-69005	385	43 max	1 350





Reversible ratchet ring spanner

Reference	 mm	 g
MO-69210	10	160
MO-69213	13	190
MO-69216	16	350
MO-69217	17	370
MO-69218	18	380
MO-69219	19	390



Special steel, oil-hardened.

Combination wrench



Reference	 mm	 mm	 g
MO-68701	150 x 150	6-8-10-12	225
MO-68702	150 x 150	8-10-12-14	260
MO-68703	150 x 150	7-9-11-13	250
MO-68704	150 x 150	8-10-13-17	250
MO-68705	150 x 150	14-17-18-21	400



Special steel insulated inserts using one-piece injection.





Special steel insulated inserts using one-piece injection.

Right angle male hexagonal key

Reference	 mm	 mm	 g
MO-69903	83 x 123	3	30
MO-69904	84 x 124	4	40
MO-69905	84 x 126	5	50
MO-69906	85 x 126	6	70
MO-69908	87 x 128	8	110
MO-69910	87 x 130	10	150
MO-69912	90 x 132	12	240







Open jaw spanner

Reference			Reference		
MO-68006	6	20	MO-68019	19	170
MO-68007	7	20	MO-68020	20	185
MO-68008	8	40	MO-68021	21	200
MO-68009	9	40	MO-68022	22	220
MO-68010	10	45	MO-68023	23	250
MO-68011	11	50	MO-68024	24	260
MO-68012	12	60	MO-68025	25	280
MO-68013	13	80	MO-68026	26	300
MO-68014	14	100	MO-68027	27	340
MO-68015	15	110	MO-68028	28	360
MO-68016	16	120	MO-68029	29	400
MO-68017	17	140	MO-68030	30	500
MO-68018	18	160	MO-68032	32	570
MO-68008/19	8 open end spanners set: 8 / 10 / 11 / 12 / 13 / 14 / 17 / 19 mm 685				





Cranked ring spanner

Reference			Reference		
MO-68106	6	30	MO-68119	19	200
MO-68107	7	35	MO-68120	20	240
MO-68108	8	40	MO-68121	21	260
MO-68109	9	45	MO-68122	22	260
MO-68110	10	50	MO-68123	23	270
MO-68111	11	65	MO-68124	24	280
MO-68112	12	80	MO-68125	25	300
MO-68113	13	100	MO-68126	26	360
MO-68114	14	120	MO-68127	27	400
MO-68115	15	150	MO-68128	28	440
MO-68116	16	180	MO-68129	29	480
MO-68117	17	190	MO-68130	30	500
MO-68118	18	195	MO-68132	32	540



Hexagonal spanner with T handle



Reference			
MO-68610	145	10	145
MO-68613	145	13	185
MO-68614	145	14	220
MO-68620	135	20	350
MO-68621	135	21	370







IEC 60900 ⚡



Pipe wrench

Reference	Socket head	 mm	 g
MO-68205	6 sided	5	20
MO-68206	6 sided	6	30
MO-68207	6 sided	7	35
MO-68208	6 sided	8	50
MO-68209	6 sided	9	60
MO-68210	6 sided	10	60
MO-68211	6 sided	11	90
MO-68212	6 sided	12	95
MO-68213	6 sided	13	130
MO-68214	6 sided	14	160
MO-68215	6 sided	15	170
MO-68216	6 sided	16	220
MO-68217	6 sided	17	230
MO-68218	6 sided	18	280
MO-68219	6 sided	19	320
MO-68220	6 sided	20	340
MO-68221	6 sided	21	470
MO-68222	6 sided	22	500





Reference	Socket head	 mm	 g
MO-68223	6 sided	23	600
MO-68224	6 sided	24	650
MO-68225	6 sided	25	700
MO-68226	6 sided	26	750
MO-68227	6 sided	27	800
MO-68228	6 sided	28	850
MO-68229	6 sided	29	900
MO-68230	6 sided	30	950
MO-68232	6 sided	32	1000

Hexagonal spanner with T handle

Reference	 mm	 mm	 g
MO-68310	305	10	350
MO-68311	305	11	360
MO-68312	305	12	370
MO-68313	305	13	400
MO-68314	305	14	450
MO-68316	305	16	560
MO-68317	305	17	650
MO-68319	305	19	750
MO-68321	305	21	800
MO-68322	305	22	850
MO-68713	405	13	650
MO-68714	405	14	800
MO-68717	405	17	900



T wrench 3/8" (9.35 mm) and 1/2" (12.7 mm) square drive

Reference	 mm	 mm	 g
MO-69523	130	3.8"	350
MO-69533	210	3.8"	450
MO-69544	350	1.2"	600



MO-69544

 mm Maximal opening

 mm Total length





 g Weight

 mm On flats

 mm Diameter

6 sided female socket 3/8" (9.53 mm) square drive - Metric and U.S Standard

IEC 60900 





Reference			Reference		
MO-69306	6	25	MO-69323	23	100
MO-69307	7	30	MO-69324	24	120
MO-69308	8	30	MO-697-1/4SAE	1/4	25
MO-69309	9	30	MO-697-5/16	5/16	30
MO-69310	10	35	MO-69735	3/8	30
MO-69311	11	35	MO-69736	7/16	35
MO-69312	12	35	MO-69737	1/2	40
MO-69313	13	45	MO-69738	9/16	45
MO-69314	14	45	MO-69739	5/8	55
MO-69315	15	50	MO-69740	11/16	60
MO-69316	16	55	MO-69741	3/4	70
MO-69317	17	60	MO-69742	13/16	85
MO-69318	18	65	MO-697-7/8	7/8	90
MO-69319	19	70	MO-697-15/16	15/16	105
MO-69321	21	85	MO-697-1SAE	1	110
MO-69322	22	90			

Others references, consult us.

Chrome steel.



12 sided female socket 1/2" (12.7 mm) square drive

Reference			Reference		
MO-69408	8	60	MO-69418	18	80
MO-69410	10	60	MO-69419	19	85
MO-69411	11	65	MO-69420	20	90
MO-69412	12	70	MO-69421	21	100
MO-69413	13	70	MO-69422	22	100
MO-69414	14	70	MO-69423	23	115
MO-69415	15	75	MO-69424	24	125
MO-69416	16	75	MO-69429	29	135
MO-69417	17	80	MO-69430	30	140





6 sided female socket 3/8" (9.53 mm) square drive long series

Reference			Reference		
MO-69608	8	55	MO-69616	16	130
MO-69609	9	65	MO-69617	17	145
MO-69610	10	75	MO-69618	18	160
MO-69611	11	85	MO-69619	19	180
MO-69612	12	95	MO-69621	21	200
MO-69613	13	100	MO-69622	22	220
MO-69614	14	115	MO-69624	24	240

Others references, consult us.

Chrome steel. L: 65 mm.



6 sided male hex Key / Socket 3/8" square drive

Reference		
MO-69393	3	45
MO-69394	4	55
MO-69395	5	60
MO-69396	6	65
MO-69397	7	70
MO-69398	8	70
MO-693100	10	80

Steel.



Male TORX 3/8" square drive

Reference			
MO-69T15	TX15 ★	60	50
MO-69T20	TX20 ★	60	55
MO-69T30	TR30 ★	105	60
MO-69T40	TR40 ★	105	80
MO-69T50	TR50 ★	105	100

Torx.



Extension pieces 3/8" square drive

Reference			
MO-69523	21.5	140	124
MO-69533	21.5	264	270



MO-69523

Sockets wrenches sets

IEC 60900 



MO-69524

MO-69308/23

Sockets 3/8"

(9.53 mm) - 6 sided



Reference	Dimensions	Weight (g)
MO-69308/23	Complete sockets 410 x 120 x 75	1 250
Composition		
MO-69308	8	30
MO-69310	10	35
MO-69312	12	35
MO-69313	13	45
MO-69314	14	45
MO-69317	17	60
MO-69319	19	70
MO-69321	21	85
MO-69322	22	90
MO-69323	23	100
MO-69513	Reversible ratchet	600
MO-69523	Extension 130	124

Sockets 1/2"

(12.7 mm) - 12 sided



Reference	Dimensions	Weight (g)
MO-69408/23	Complete sockets 410 x 120 x 75	1 500
Composition		
MO-69408	8	60
MO-69410	10	60
MO-69412	12	70
MO-69413	13	70
MO-69414	14	70
MO-69417	17	80
MO-69419	19	85
MO-69421	21	100
MO-69422	22	100
MO-69423	23	115
MO-69514	Reversible ratchet	600
MO-69524	Extension 125	250

Others references 1/2 », consult us.

Accessories

Plastic case without tools.

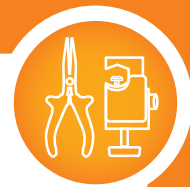

Reference	Dimensions (mm)	Weight (g)
MO-69503	410 x 120 x 75	250

Other references, consult us.





IEC 60900 ⚡

Ratchet spanners

Reference	 mm	 mm	 g
MO-69512	1/4"	125	150
MO-69513	3/8"	190	250
MO-69514	1/2"	255	600
MO-69515	3/8"	215	360



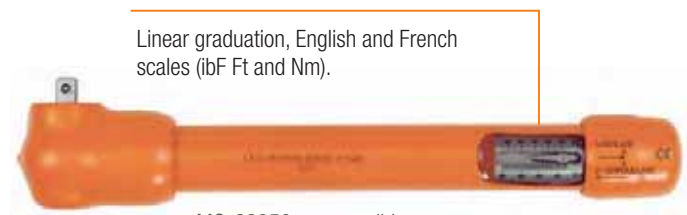

Torque wrench 3/8" square drive

Reference	 mm	\vec{F}_{Nm}	 g
MO-69050	330	8 to 50 Nm	790
MO-69051	235	4 to 20 Nm	500
MO-69054	290	8 to 50 Nm	850



Fully insulated scissors

Reference	 mm	 g
MO-72100E	132	80



Screwdrivers kit

IEC 60900 

Reference	KIT-03
Composition	
MO-65242	POZIDRIV screwdriver N°1
MO-65244	POZIDRIV screwdriver N°2
MO-65204	Flat blade screwdriver 3.5 x 100 mm
MO-65206	Flat blade screwdriver 5.5 x 125 mm
MO-65209	Flat blade screwdriver 8 x 175 mm



Pliers kit

Reference	KIT-07
Composition	
MO-66002	Universal pliers overall length 180 mm
MO-66502	Water pump pliers overall length 250 mm
MO-67302	End stripping pliers 160 mm
MO-66402	Bent snipe nose pliers overall 160 mm
MO-67500	Cable cutter 170 mm



Intervention kit

Reference	KIT-04
Composition	
MO-65242	POZIDRIV screwdriver N°1
MO-65244	POZIDRIV screwdriver N°2
MO-65204	Flat blade screwdriver 3.5 x 100 mm
MO-65206	Flat blade screwdriver 5.5 x 125 mm
MO-65209	Flat blade screwdriver 8 x 175 mm
MO-67302	End stripping pliers overall 160 mm
MO-66402	Bent snipe nose pliers overall 160 mm
MO-67500	Cable cutter 170 mm



Complete intervention kit

Reference	KIT-05
Composition	
MO-65242	POZIDRIV screwdriver N°1
MO-65244	POZIDRIV screwdriver N°2
MO-65204	Flat blade screwdriver 3.5 x 100 mm
MO-65206	Flat blade screwdriver 5.5 x 125 mm
MO-65209	Flat blade screwdriver 8 x 175 mm
MO-66002	Universal pliers overall 180 mm
MO-66502	Water pump pliers overall 250 mm
MO-67302	End stripping pliers overall 160 mm
MO-66402	Bent snipe nose pliers overall 160 mm
MO-67500	Cable cutter 170 mm





Insulated tools

Electrician tool bag

Reference	mm	kg
M-87370*	440 x 330 x 160	1.1

* Delivered without tools.

Ajustable shouldes shap.



Reinforced bottom.

Tool bag

Reference	mm	kg
M0-37	400 x 310 x 250	0.6

* Delivered without tools.

Multipockets inside.



Ajustable shouldes shap.

High resistance canvas.

Back pack for tools

Reference	mm	kg
M0-38	400 x 300 x 180	0.6

* Delivered without tools.

Wide adjustable strap.



Multipockets inside.

Reinforced back.

Reinforced zip.

High resistance canvas.

Tool box

Reference	mm	kg
M0-39	480 x 320 x 230	0.9

* Delivered without tools.

Ajustable shouldes shap.



Retractable handle.

High resistance canvas.

Flat tool case

Reference	mm	kg
M-87303	400 x 380 x 60	1



Strong waterproof canvas.

Multi-pockets inside.

Tool bag

Reference	mm	kg
MO-34	410 x 280 x 150	3.2



Black grained leather with handle.

The interior includes: a pocket, a separation which forms a tool tray and a fold-down tool tray.

Tool bag

Reference	mm	kg
MO-36	200 x 250 x 450	4.8



Silicon grain leather totally sewn. Strong leather handle and shoulder strap.

Separation which forms a tool tray.

Reinforced bottom.



Low voltage complete set.
Complete equipment for live line (LV) interventions.



Reference	MO-510-03 *
Personal equipment	
MO-186	1 face shield
CG-98-C	1 working gloves size C
CG-05-B	1 rubber gloves size B
CG-36	1 carrying bag for rubber gloves
MP-42/16	1 insulating mat 3 mm
Voltage detector	
MS-917	1 voltage detector
Insulating	
MP-26-A	10 insulating caps
MP-35/12	1 insulating blanket
MP-4110	10 wood clamps for insulating blanket
MP-32/15	6 line protectors 1.50 m
MP-19	5 insulating adhesive tapes
Insulating tools	
MO-61001	1 stripping knife
MO-67502	1 cable cutter 230 mm
MO-68008/19	1 open end spanners set with 8 / 10 / 11 / 12 / 13 / 14 / 17 / 19 mm

* Delivered without tool bag.

following... MO-510-03 *	
Insulated tools	
MO-69903	1 right angle hexagonal key wrench 3 mm
MO-69904	1 right angle hexagonal key wrench 4 mm
MO-69906	1 right angle hexagonal key wrench 6 mm
MO-751	1 insulating folding rule
MO-69003	1 adjustable spanner 250 mm
MO-66002	1 universal pliers 180 mm
MO-66202	1 round nose pliers 160 mm
MO-66502	1 water pump pliers 250 mm
MO-67102	1 side cutter 160 mm
MO-69308/23	1 sockets 3/8" wrench set with 10 sockets: 8, 10, 12, 13, 14, 17, 19, 21, 22, 23
MO-65205	1 flat blade screwdriver 4 x 100
MO-65207	1 flat blade screwdriver 6.5 x 150
MO-65209	1 flat blade screwdriver 8 x 175
MO-65232	1 Phillips screwdriver n° 1
MO-65234	1 Phillips screwdriver n° 2
MO-65236	1 Phillips screwdriver n° 3

* Delivered without tool bag.

Tool bag to order separately

Reference	Characteristics
MO-34	Leather tool bag , see page 112
MP-01	Bag for insulating mats, see page 29

Reference	Characteristics
M-87384	Bag for face shield and helmet, see page 20
M-87386	Multi-pocket electrician bag, see page 30



Dimensions



Weight

Intervention kit for electricians

IEC 60900 

Reference	MO-38510
Composition	
M-87370	1 tool bag
CG-05-C	1 pair of insulating gloves size C
MO-11001	1 safety glasses
AL-230-111	1 safety padlock
MO-65204	Flat blade screwdriver - 3.5 x 100 mm
MO-65206	Flat blade screwdriver - 5.5 x 125 mm
MO-65209	Flat blade screwdriver - 8 x 175 mm
MO-65242	POZIDRIV screwdriver - N°1 4.5 x 80 mm
MO-65244	POZIDRIV screwdriver - N°2 6 x 100 mm
MO-66002	Universal plier - length 180 mm
MO-66402	Bent snipe nose plier - length 160 mm
MO-67302	End stripping plier - length 160 mm
MO-67500	Cable cutter - length 180 mm
MO-66502	Water pump plier - length 250 mm



Our *LV Live working* guide is available.

All our guides and catalogues are available on request or downloadable from our website:



www.catuelec.com



Jumper clamps, cables and accessories

Mini jumper clamps fully insulated for switchboard use

These clamps are specially designed for use on energized parts in LV installations (switchboards, etc.) to make temporary connections. Isolated bronze jaws designed to axially grip conductors can be used on threaded bolts or shanks and nuts. All other models in this series tighten with T-handle screw, and receive cable terminals

Reference	 mm	 g
MC-141	150 x 75 x 25	200
MC-142	33 x 38 x 58	130
MC-143	115 x 70 x 25	150
MC-144	23 x 75 x 150	280
MC-145	23 x 70 x 110	220
MC-146	23 x 70 x 110	230
MC-147	100 x 70 x 25	100
MC-147/1	100 x 70 x 25	100
MC-148	80 x 70 x 25	150
MC-148/1	80 x 65 x 25	100
MC-149	160 x 60 x 55	300

MC-141



Six-sided
17-19 mm.

MC-142

Axial
(at cable end)
+
transversal



Adjustable clamp
round Ø 6-10 mm
flat 5 mm.

MC-143



Flat bar,
thickness
2-25 mm.

MC-144



Round 8-12
square 9-10 mm.

MC-145

Wire clamp for
stripped cables
Ø 3 to 10 mm.



Transversal

MC-146

Wire clamp
for stripped
cables
Ø 10 to 24 mm.



Transversal

MC-149



Flat bar,
thickness
20-30.

MC-147



Threaded rod M8
MC-147.
Threaded rod M10
MC-147/1.

MC-148



For shunt 200 A.

Clamp with tapped revolving rod
end M8, 200 A shunt. To be used
with an insulating six-sided male
hex key 5 mm.

MC-148/1

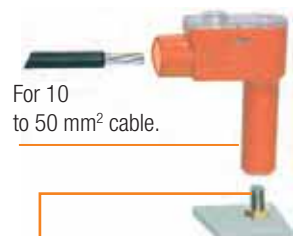

For 10
to 50 mm² cable.

Clamp with tapped
revolving rod end M8.



Dimensions



Weight

Jumper cables

LV live working tools.

Reference	↔	g	Sections mm ²
MC-153/05	0.5 m	270	35
MC-153/10	1 m	570	35
MC-153/30	3 m	1 720	35
MC-153/60	6 m	3 460	35
MC-155/05	0.5 m	380	50
MC-155/10	1 m	760	50
MC-155/20	2 m	1 520	50
MC-155/30	3 m	2 280	50
MC-155/60	6 m	4 560	50
MC-155/80	8 m	6 080	50

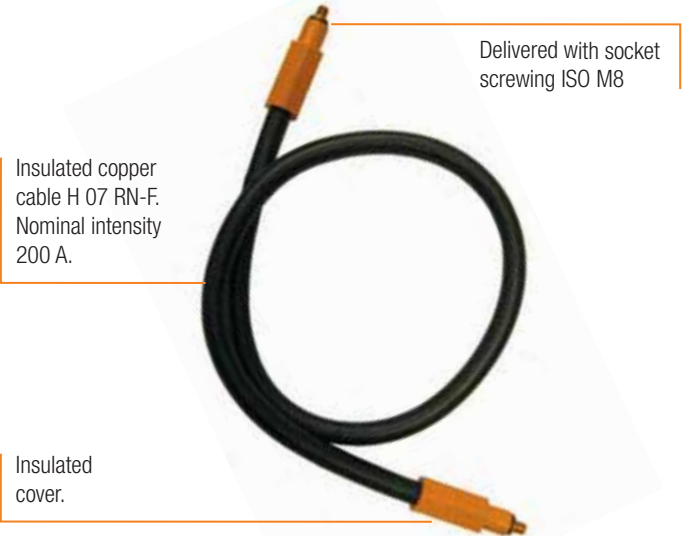

Jumper cable with insulated jumper clamps

Reference	↔ mm	g
MC-121	60 x 25	50
MC-122	125 x 35	100
MC-123	125 x 35	100
MC-124	125 x 35	100

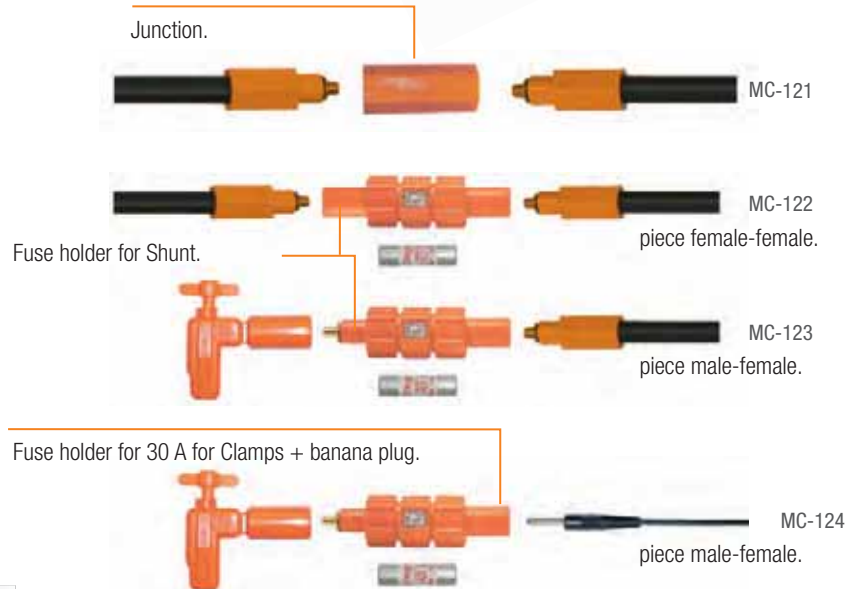

Jumper cable with insulated jumper clamps

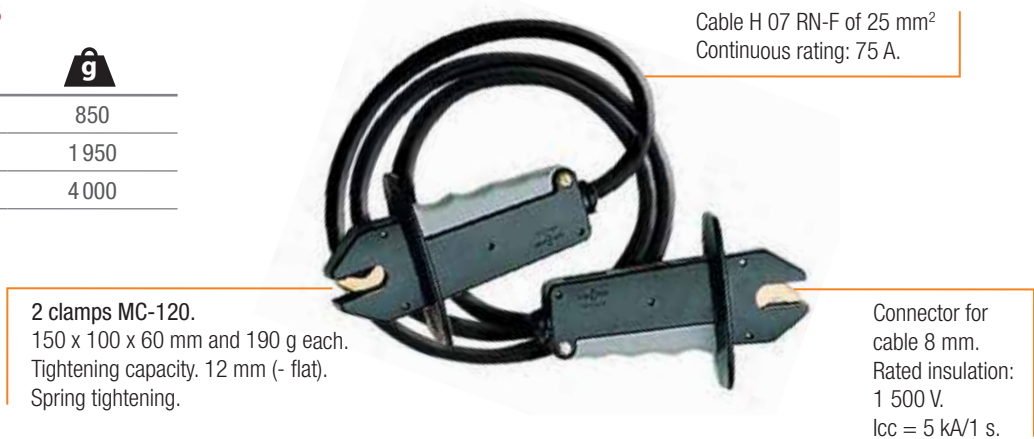

Reference	↔	g
MC-120/15	1.5 m	850
MC-120/50	5 m	1 950
MC-120/100	10 m	4 000





Jumper clamps, cables and accessories

Threaded adapter

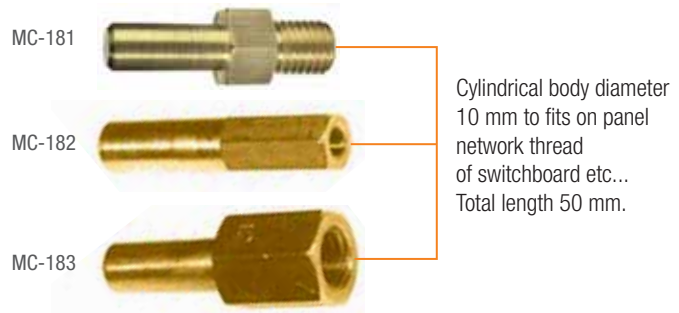

Reference	 mm	 mm	 g
MC-181	50 x 13	M10	50
MC-182	50 x 10	M8	27
MC-183	50 x 17	M12	48

Set of 4 adapters by reference.



Shunt Telescopic probe

Reference	Sections mm ²	Current
MC-126	1.5 to 16	60 A
MC-126/1	10 to 70	100 A

Reference	 mm	 g
MC-150	173 x Ø 32	185

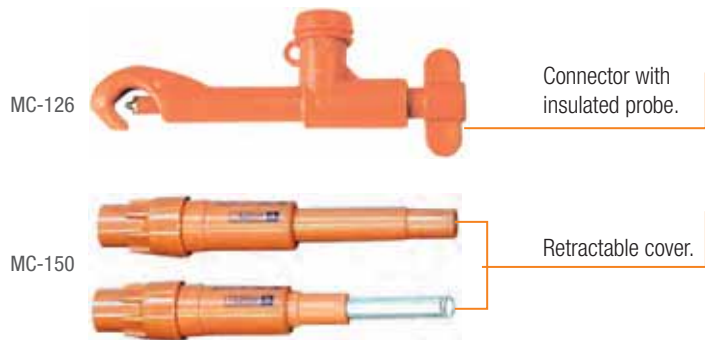

Bypass housing

Reference	Characteristics
MC-156	Box 40 x 80 x 158 mm
MC-156/1	Spare part
MO-237-D	Triangular spanner witch T hande

The six removable fittings can be separated by the triangular spanner.

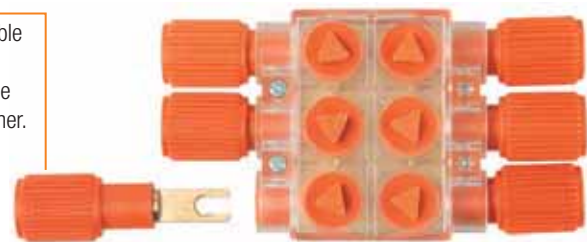

The housing allows on each side to connect 3 by pass jumpers.

Jumper connecting box with fuse

Reference	Intensidad
MC-116	30 to 200 A



The shunt for collective channeling is a box used to make sure, before proceeding to the replacement of a molten fuse situated on a channeling, that the defect which brought about the molten is eliminated. This box is used with a fuse when the (nominal) assigned intensity of the channeling is < 100 A and with 2 fuses when this intensity is included between 100 A and 200 A. It can also be used to open a circuit in load, for example to change a damaged accessory such as a pin.

Shunt for collective pipes.



Insulator cover

For LV insulator.

Reference	Characteristics	 mm	 mm	 g
MP-22	Line insulator	150 Height	110	475
MP-23	Dead end insulator	210 Height	180	1 145

ST TST BT N°435

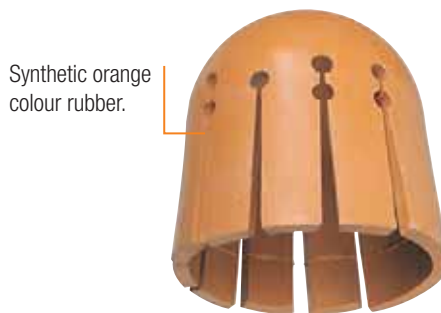



Bag for insulator cover

Reference	 mm	 g
MP-50	Ø 300 x H 400 mm	650



End cap for conductor cable



Reference	 mm out	 mm in		Section mm ²
MP-26-A	10	6.5	6 cm	4 to 10 mm ²
MP-26-B	15	11	10 cm	10 to 35 mm ²
MP-26-C	20	15	12 cm	16 to 70 mm ²
MP-26-D	25	20	12 cm	25 to 120 mm ²
MP-26-E	35	30	12 cm	to 300 mm ²

ST TST BT N°430



Flexible - type conductor cover

For LV conductors.

Reference		 g
MP-32/10	1 m	410
MP-32/15	1.5 m	620
MP-33	3 m	1 230

ST TST BT N°440



Flexible - type conductor cover

For overhead network (< 1 000 V).

Reference	Characteristics	 g
MP-31	Sipral shape type 5 m	600
MP-59	Indent tool for MP-31	180

ST TST BT N°445

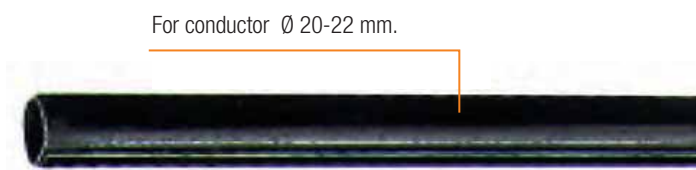



Insulating flexible blanket

Electrical Insulating blanket

The electrical insulating blanket is used for the protection of workers from accidental contact with live or earthed electrical conductors, apparatus or circuits and avoidance of short circuits on electrical installations.

Electrical Insulating blanket

In accordance with IEC 61112 standard and according class 0 specifications. Operating voltage: 1000 V AC and 1500 V DC.

In accordance with specific properties:

Category A: acid resistant.

Category C: resistant to very low temperature (-40°C).

Category H: oil resistant.



Recommendations for use

Storage/Transport

Insulated blanket should be properly stored to avoid the risk of damage to the insulating material.

Do not store or use close to excessive heat.

Do not expose to direct sunlight for long period.

Storage temperature: 10°C to 21°C.

Before use

Insulating blanket cut from a roll should keep visible markings.

Each side of the blanket should be. Visually inspected by the user.

The unsulating blanket must not have tears or holes. If the blanket

is dirty, wash it with soap and water. Dry it with respect of using temperatures.

In use

Operating temperatures: -40°C to +55°C.

Avoid contact with chemical products. Do not walk on the insulating blanket.

Periodic inspection

Insulating blanket should not be used without having been electrically tested within twelve month preceding with the exception of class 00 and 0.

Only visual inspection is required for class 00 and 0.

ACCESSORIES SEE PAGE 121

Clamp and adhesive tape.



MP-41530



MP-19-LOT



Dimensions



Diameter



Weight

Insulating flexible blanket

Polyvinyl in roll.











MP-35

Flexible translucent polyvinyl.







MP-37

IEC 61112 
Class 0
1 000 V 
1 500 V 

Reference	Class	Operating voltage		 m	 mm	 kg
						
MP-35	0	≤ 1 000 V	≤ 1 500 V	1.3 x 25	0.3	12
MP-35/12	0	≤ 1 000 V	≤ 1 500 V	1.3 x 12.5	0.3	6
MP-37	0	≤ 1 000 V	-	0.09 x 25	0.3	0.8





Insulating flexible blanket orange rubber

Reference	Class	Operating voltage		 m	 mm	 kg
						
MP-220	0	≤ 1 000 V	≤ 1 500 V	1 x 1	1	1.5
MP-220/1	0	≤ 1 000 V	≤ 1 500 V	1 x 10	1	15



Insulating flexible blanket reinforced polyvinyl

Individual model.

Reference	Class	Operating voltage		 mm	 mm	 g
						
MP-123	0	≤ 1 000 V	≤ 1 500 V	360 x 660	0.5	150
MP-123/1	0	≤ 1 000 V	≤ 1 500 V	500 x 900	0.5	290
MP-123/2	0	≤ 1 000 V	≤ 1 500 V	800 x 1 200	0.5	600

Translucid polyvinyl.
Reinforced by a grid
of synthetic fibre.





The «Velcro™» type allows the flexible blanket to be closed by pressing the edges together. Several flexible blanket can also be connected in this manner.



Cover-up equipment

Insulating flexible blanket LV/MV



Reference	Characteristics	 m	 mm	 kg
MP-40	In roll	1.3 x 25	0.8	24

In accordance with **ST HTA 50D** EDF-SERECT specification.

Flexible translucent vinyl materiel.



Blanket clamp

Reference	 mm	 g	
MP-4110	160	60	1
MP-41530	65	10	12

Insulating plastic clamp with spring.



MP-4110



Bimaterial insulating clamp.



MP-41530

ST TST BT N°415

Electrical adhesive tape

Reference	 m	
MP-19-LOT	0.015 x 10	Set of ten rolls



* Brown, yellow, red, orange, blue, white, black, green, green/yellow, grey.



IEC EN 60454

Large electrical adhesive tape

Rubber and PE compound
Dielectric resistance : 2.5 kV.

Reference	 m	
MP-19/1	0.05 x 50	Red

Obstacle or distance protection,
see chapter **locking and signaling**.



IEC EN 60454

 Dimensions  Thickness  Weight

 Total length  Packaging



Cable Identifier

The **MX-400** includes a modulator **A** and a receiver **B**.

The **MX-400** is a cable identifier that is particularly well suited for quickly identifying underground cables and insulating overhead lines. It is also designed for identifying phases. This identifier is used on any type of power distribution network with rated voltages of 230 to 400 Volts.

Operating voltage: 230/400 V +/- 10%.
 Frequency: 50 Hz +/- 10%.
 Operating temperature: - 10° to + 55°C.
 Storage temperature: - 20° to + 70 .
 Class II modulator.

The **modulator** is an electronic power system that draws current pulses in 10-millisecond intervals at a frequency of 1 Hertz. Current limited by fuse, HPC 100 kA aM 10 A.

Reference	 mm	 kg
MX-400	510 x 465 x 216	10.6

Comes complete with an ABS case, 2 cables, and 1 amperemetric clamp.

H07RNF power cables.
 (6 mm² and 3 m length).
 The connection is made between phases for identifying the cable or between phase and neutral for identifying a phase. After connection, the device is immediately live, as indicated by two 230 and 400 Volts lights.



The **receiver** is equipped with two sensors that detect the passage of pulses drawn by the modulator. Once these pulses are received, the device emits a light signal, confirmed with a beep after three seconds. Receiver powered by 9 V lithium type 6LR61 battery. Sensor sensitivity adjustable to 15 levels. Detection can easily be adjusted, which accordingly affects identification accuracy.



The phase is identified with an **amperemetric clamp** connected to the receiver and positioned around the phase to be identified. When the clamp detects pulses drawn by the modulator, the receiver emits a light signal, confirmed by a beep after three seconds.

Accessories

Reference	Characteristics
MX-400/1	Modulator + receiver
MX-400/6	Receiver
MX-400/7	Amperemetric clamp
MC-1421	Connection clamp



MV Substation equipment

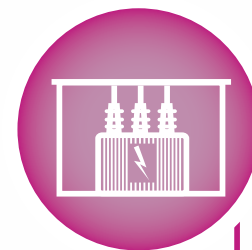

Safety equipment	124
Substation equipment	125
Voltage detectors and short-circuiting systems for substations with bare conductors	126
Voltage detectors	127
Phase comparators	129
Two-pole phase comparator and permanent indicator	130
IEC short-circuiting and earthing systems for MV substations	131
Clamps for MV installations and substations	133
Short-circuiting and earthing systems	134
VPIS and VDS systems for M.V. cubicles	136
Extra safety equipment	138
Life saving kits	140



Keep your substations in compliance

Special regulatory signaling

The standard recommends the following signaling in substations:

- A substation poster,
- Two posters about what to do in the event of an indoor or outdoor electrical emergency,
- A poster displays the service rules.

All of these posters comes in kits that were specially designed by CATU to get your substations in compliance.



Safety Equipment

The standard recommends the following service equipment:

- An insulating platform or an insulated mat,
- A rescue pole,
- A pair of insulating gloves adjusted to the sub-station's rated voltage,
- A voltage detector (see below for information)
- A grounding and short circuit device (see below for information)
- A glove box,
- A fuse holder.

CATU has assembled all of the service equipment into kits to simplify your selection and to bring your facilities into compliance right away. This equipment must include a suitable voltage detector.





Intervention kits

Reference	Characteristics
KIT-01	Intervention kit with insulating platform
KIT-02	Intervention kit with insulating platform
KIT-10	Intervention kit with insulating mat delivered with a protective P.V.C. container

Reference				Characteristics		mm
KIT-01	KIT-02	KIT-10	Composition of kits			
•	–	•	CG-3-10-NR	Insulating rubber gloves Classe 3	26 500 V max	Size 10
–	•	–	CG-4-10-NR	Insulating rubber gloves Classe 4	36 000 V max	Size 10
•	•	•	CG-35/2 *	Rubber gloves box	–	60 x 210 x 460
•	•	•	CI-23 *	Fuse holder	Ø maxi 85 mm	90 x 240 x 260
•	•	•	CS-45 **	Rescue stick	45 000 V max	Long. 1.65 m
•	•	•	CI-06-D	Wall mounted supports	Delivered with CS-45	–
•	•	–	CT-7-25/1	Insulating platform	24 000 V max	500 x 500 x 220
–	•	–	CT-7-40/1	Insulating platform	40 000 V max	500 x 500 x 220
–	–	•	MP-42/16	Insulating MAT IEC-61111	Class 3 - 26.5 kV	0.6 m x 1 m
–	–	•	MP-20	Mat storage box	–	Ø 10 cm x 1 m



* Delivered with fixations.
**Delivered with wall mounted supports CI-06-D.



CG-35/2



CI-23



CI-06-D



CT-7-25/1
CT-7-40/1



CG-3-10-NR
CG-4-10-NR

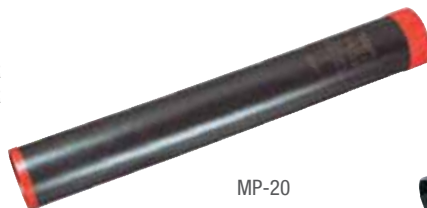

MP-20

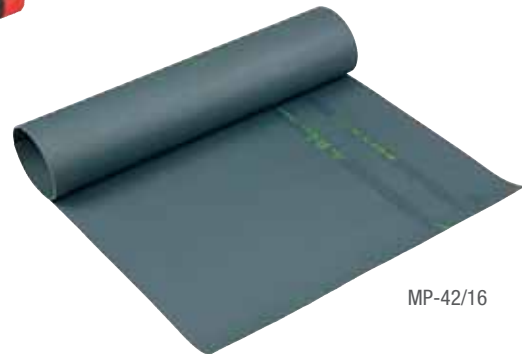

MP-42/16



The KIT-01 is complemented by an appropriate detector: see pages 127, 128, 142 and 143.

IEC electronic Voltage Detectors, "Compact serie" for indoor and outdoor use

IEC 61243-1
CE

Ultimate technology of voltage detector "Head Capacitive Technology"

Compact and light, it offers a wide band (10/36 kV).

Operating check:

By pressing the TEST button:

- A **RED** LED flashes on.
 - Powerful rated audible signal > 60 dB(A)/2 m.
 - When loosening the button, the timed **GREEN** LED lights up.
- While remaining on, it indicates the good working order of the detector.

Characteristics:

- Precise and stable operating threshold.
- High environmental resistance (impacts, vibrations, moisture).
- Temperature conditions: class N (IEC -61243-1 standard).
- Use from 50 to 60 Hz.



IEC Voltage detector

In compliance with IEC-61243-1.

CC-765 high environmental resistance: impacts, vibrations, moisture.

Recommended stick **CE-4-21-C**.

Reference	Characteristic	~	mm	g
CC-765-55/20-(*)	Voltage detector in storage box	5.5/20 kV	Ø 59 x 270	350
CC-765-3/10-(*)	Voltage detector in storage box	3/10 kV	Ø 59 x 270	350
CC-765-10/36-(*)	Voltage detector in storage box	10/36 kV	Ø 59 x 270	350
CC-765-10/30-(*)	Voltage detector in storage box	10/30 kV	Ø 59 x 270	350

(*) Specify type of mounting when ordering: C or K.
For other voltage range: contact us.

Contact electrodes fitted to the housing by screwing and easily interchangeable.



CC-765-10/36 - C

Voltage presence is indicated by:
RED flashing LED (very bright - visible at more than 20 m in direct lighting).

IEC Insulating stick for Voltage Detector

Stick in compliance with IEC 61235.

Reference	~	↔
CE-4-21-*	90 kV	2 m

* C, E or K.



Telescopic stick.

Hand guard.

CE-4-21-C



IEC 61243-1

IEC electronic Voltage Detector, with antenna for indoor and outdoor uses

DESCRIPTION

- Ultimate "head capacitive technology" of voltage detector.
- Universal application 50 / 60 Hz and wide band of voltage from 5 to 30 kV.
- Type S (Substation) with electrode extension.
 The electrode extension is designed to ensure no inside failure.
- Equipped with its insulating stick : Assembly by screwing.

CHARACTERISTICS

- Temperature conditions: class N (-25 to 55°C).
- Type S (with electrode extension).
- Electrode extension diameter : 14 mm.
- Power supply: 1 standard 9 V battery 6LR61.
- Network frequencies : 50 and 60 Hz.
- Contact electrodes fitted by screwing and easily interchangeable.
- Packaging: supplied in a carrying bag with zip (930 mm x 200 mm) and transparent side pocket.
- In compliance with the standard IEC 61243-1 Ed 2 (2003).
- CE marking complies with EMC immunity regulations.

Reference			
CC-965-10/30	10 to 30 kV	Length: 1.55 m Diameter: 59 mm	850
CC-965-5/15	5 to 15 kV	Length: 1.45 m Diameter: 59 mm	820

Assembly by screwing.

Robust thermoplastic housing.



Voltage presence is indicated by:
RED flashing LED (very bright, visible at more than 20 m in direct lighting).
 Powerful rated audible signal > 67 dB (A) / 1.5 m.

Hand guard.



Accessory

Plastic carrying case: REF. M78723.



Robust thermoplastic housing.

Assembly by screwing.



Voltage detector with leds for indoor use without batteries

Built-in device for checking operation of the led's indicator via a piezo-electric generator. High-brightness led's indicator.

Reference	~	↔ Folded up	↔	g
CL-4-10/30-M *	10-30 kV	-	1.35 m	1 000
CL-4-10/30-2 **	10-30 kV	0.85 m	1.26 m	950

* Delivered in vinyl sheath with wall brackets CI-06-D.
** Delivered in canvas, waterproofed with ramp.



Ø 58.5 mm compatible with aperture housing.

C 18-311
CE

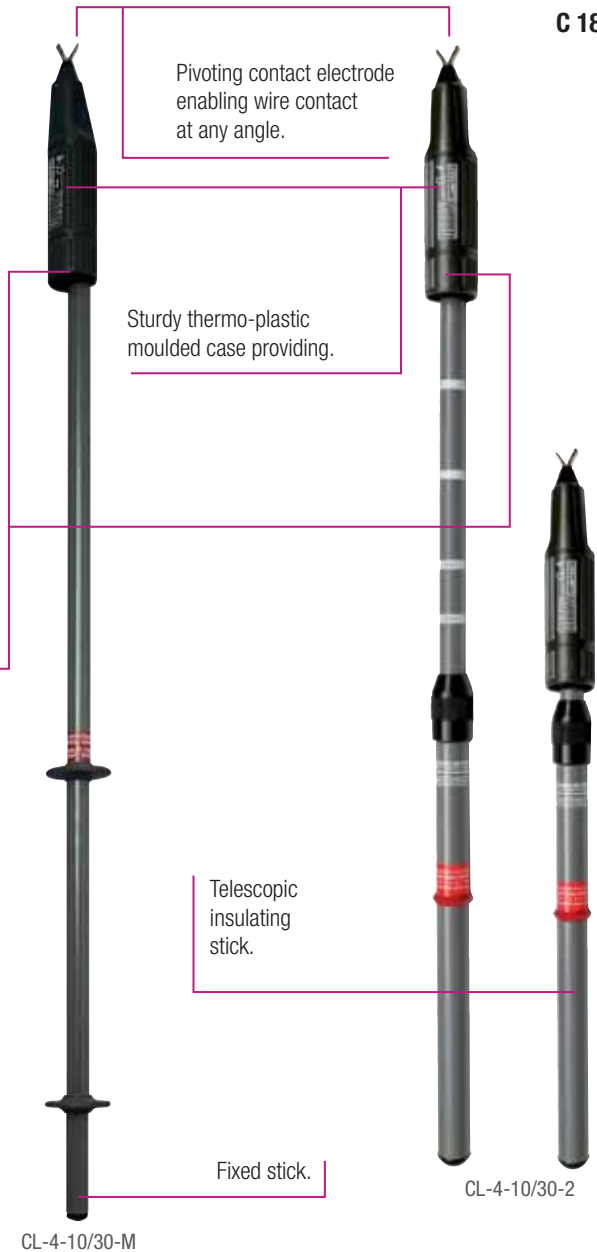

Voltage detector with leds for indoor use (Compact serie) without batteries

For indoor use. This compact serie voltage detector is designed to be carried easily by operators. Voltage presence is indicated by a high-brightness LED's indicator. Built-in device for checking of the LED's indicator by a piezotest generator.

Reference	~	↔ Folded up	↔	g
CL-2-5/36-2	5-36 kV	0.33 m	0.9 m	400
CL-2-10/30-2	10-30 kV	0.33 m	0.9 m	400

Other models fixed or telescopic, please contact us.
Delivered in holster.

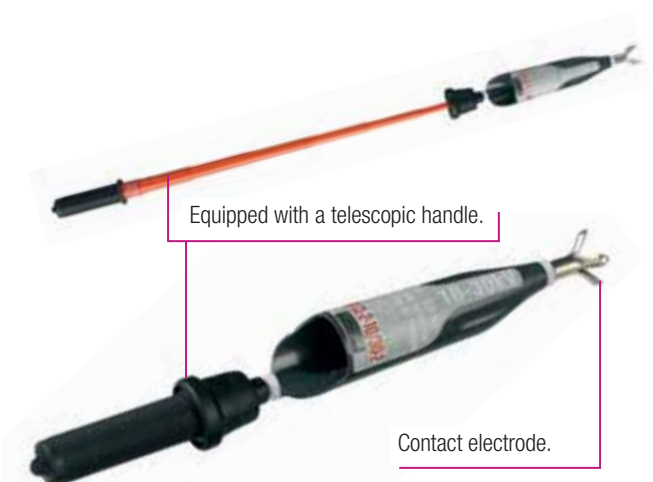



Two-pole phase comparators for indoor use

The **DETEX CL-8-36** detects differences in voltage between any two points of an installation indicated by LED's. It also enables assessment of the order of magnitude of the residual voltage induced by nearby live lines or circuits, and thus differentiates it from the one provided directly from a high voltage source.

Reference		↔ aerial		
		assembled	dismantled	
CL-8-36	2 à 36 kV	1.25 m	0.62 m	1.1
CL-8-36/1 *	2 à 36 kV	1.25 m	0.62 m	1.3

* As CL-8-36 tester with 2 probes extenders 0.550 m. Câble 1.5 m for CL-8-36 and 3 m for CL-8-36/1. Delivered in plastic case.

Accessories

Reference	Description
C-92-20	Spare probe 0.550 m
CL-8-05	Probe extenders 0.550 m

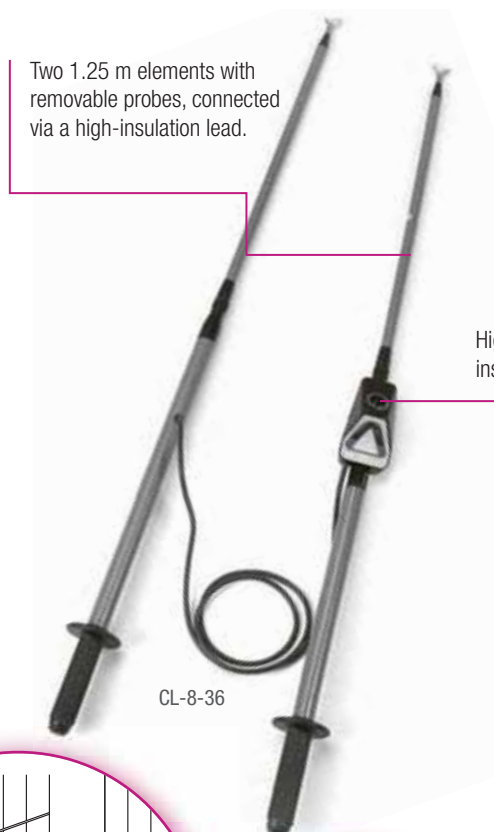

Two 1.25 m elements with removable probes, connected via a high-insulation lead.

High dielectric quality insulating material.

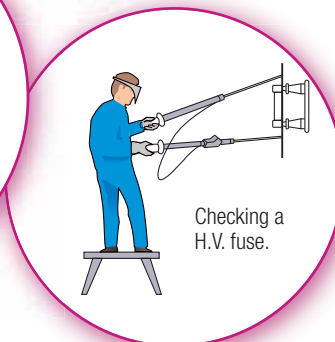
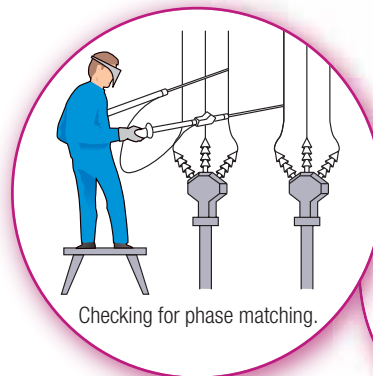

Operating Testers

To perform mandatory testing on the controllers before and after each use.

Reference	Characteristic			
			mm	
CL-1-06	Delivered in case with lead	Adjustable 10, 20, 30 kV	190 x 32 x 65	320



Unlike single-core voltage testers, dual core testers can recognize potential differences between any two points in an MV installation. Primarily reserved for conductors of the same phase (matching), they can also be used for dual core detection and for testing MV fuses.





CL-1-06

Two-pole phase comparator for indoor and outdoor use

Complete function testing: built-in, with TEST push-button (battery supplied).
 Consists of two elements connected by a high-insulation lead.
 Removable handles.
 Device delivered in metal case.
 140 x 250 x 850 mm - 7.5 kg.



Reference	Graduation cadran (kV)	 type 6 LR-61	 9 V	 7.5
CL-5-36	5 - 10 - 15 - 20 - 25 - 30 - 33 - 36	5 - 36 kV	9 V	7.5
CL-5-03	0.750 - 1 - 1.25 - 1.5 - 3	0.75 - 3 kV	9 V	

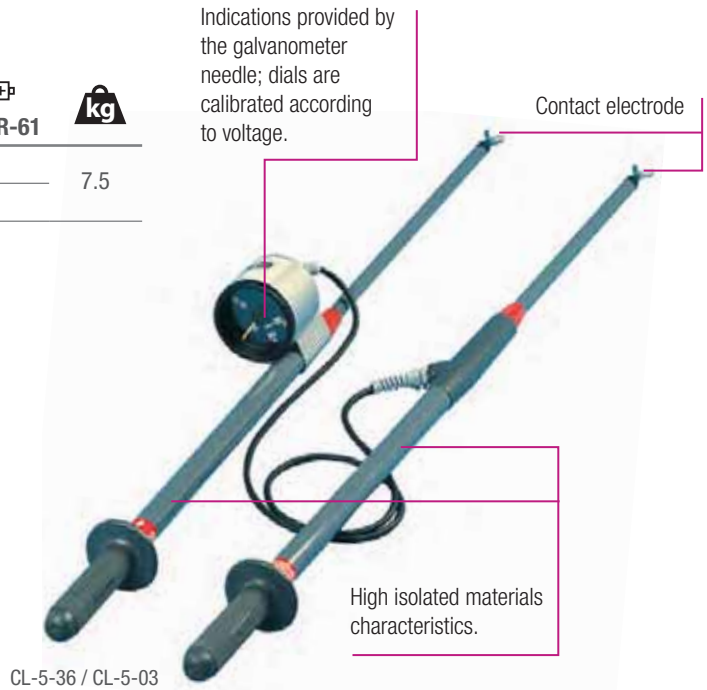

Permanent luminous indicator for indoor use

Single-pole 5 to 75 kV indicator.

Reference	
CL-40010	Sold in box of 3 units

Signaling the presence of voltage by 7 electroluminescent diodes.





IEC short-circuiting and earthing systems for MV substations

Installation on permanent fixed points

Reference	Rating (kA/1 s)	Installation on fixed points	Composition	Connection set
MT-1910	20	Ø 20 mm MT-2951 range	3 clamps MT-1911-E 1 MT-1911	3 cables 95 mm ² 1 earth cable 35 mm ²
MT-1920	30	Ø 25 mm MT-3951 range	3 clamps MT-1921-E 1 MT-1921	3 cables 150 mm ² 1 earth cable 50 mm ²

Delivered in case



IEC 61230



Installation on permanent fixed points

Reference	Description
MT-890	Clamps 3 claws
MT-891	Earth clamp fixation
MT-893	Cable tensioner
MT-895	Cable kit support
CI-10-D	Wall mounted support
M-78665	Plastic case MT-1910 or MT-1920

Fixed points (characteristic page 134).



Plastic case.



3 contact clamps.

3 fixed points.

MT-1910
MT-1920

3 copper cables MCC, IEC extra flexible silicone sheath, L = 1.5 m.

CF-5-40-E

Insulating stick.

Earth clamp.

1 trifurcation connector earthed by an extra-flexible copper cable with silicone sheath, L = 2.5 m.

Earth clamps

Claw for "T" or round fixed points for round conductors.

Reference	Characteristic	Rating (kA/1 s)	
MT-1911-E	Claw for "T" fixed points MT-1951... Ø 20 mm MT-2951... round fixed points Ø 8 à 18 mm	20	580
MT-1921-E	Claw for "T" fixed points MT-1951... round fixed points Ø 25 mm MT-3951... round conductors Ø 10 à 25 mm	30	690
MT-1911	Same characteristics with handle MT-1911-E	20	-
MT-1921	Same characteristics with handle MT-1921-E	30	-
M-9573	Handle alone C and fitting	-	-

Delivered with screws M 12.



Installation on bare conductors

IEC 61230



Reference	Rating (kA/1 s)	Installation on fixed points	Composition	Connection set
MT-5805	20	<ul style="list-style-type: none"> • Ø 5-35 ■ 16-40 ■ 5-40 	3 clamps MT-815-C 1 MT-840/1	3 cables 95 mm ² 1 earth cable 35 mm ²
MT-8408	12,5	<ul style="list-style-type: none"> • Ø 18-33 ■ - ■ - 	3 clamps MT-814/3 1 MT-840/1	3 cables 70 mm ² 1 earth cable 35 mm ²
MT-9801	10	<ul style="list-style-type: none"> • Ø 5-16 ■ 0-16 • Ø 5-28 	3 clamps MT-817-C 3 clamps MT-814/2 1 MT-840/1	3 cables 50 mm ² 1 earth cable 25 mm ²

Delivered in case.
Clamp characteristics : see page 133.

Installation on permanent fixed points

Reference	Description
MT-890	Clamps 3 claws
MT-891	Earth clamp fixation
MT-893	Cable tensioner
MT-895	Cable kit support
CI-06-D	Wall mounted support

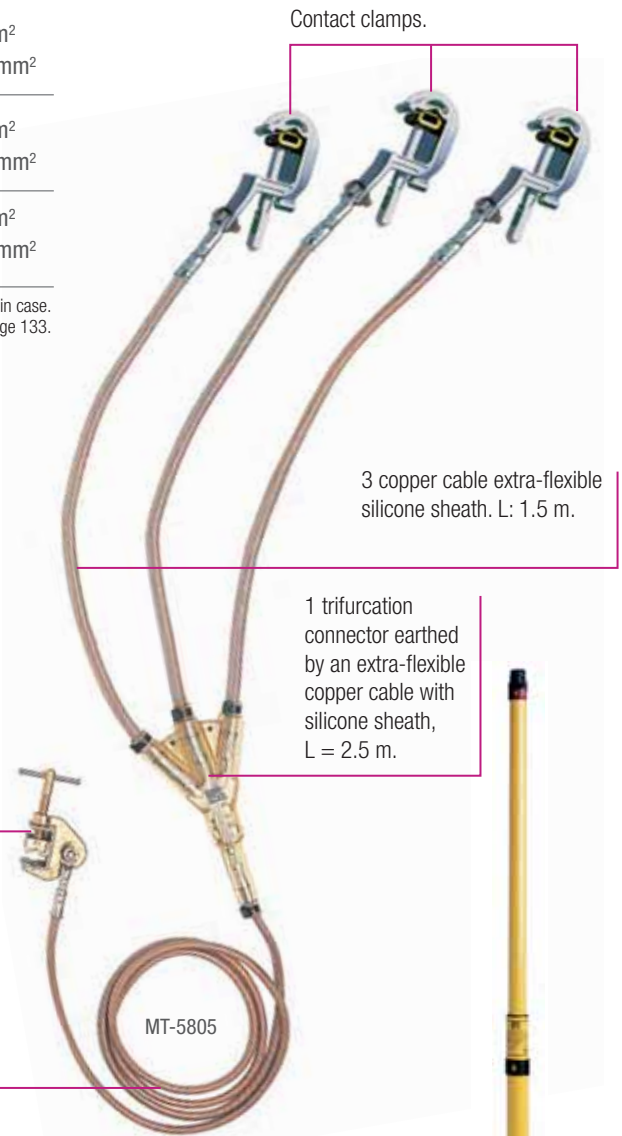

Insulating stick to be ordered separately.



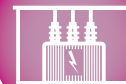

Clamps for MV installations and substations

Clamps for installation on bare conductors

Attachment (C-Type)

Hexagonal end-fitting. A circumferential braking system prevents the clamp from turning under the weight of the cable. Separate by simple pulling.

Earth cable connection.

With a crimped lug (12 mm Ø hole).

Material

Aluminium alloy except **MT-814/2** and **MT-814/3**: copper-aluminium bronze.

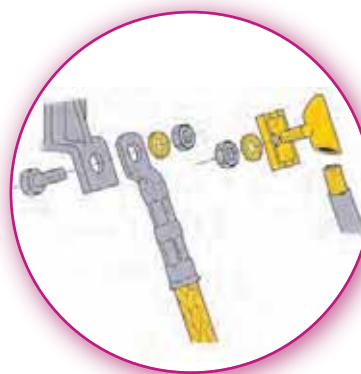

Reference	Rating (kA/1 s)	Dimensions (mm)	conductor (mm)	Weight (g)
MT-811-C	21	35 x 77 x 157	• Ø 5-16 — 0-16	330
MT-812-C	21	35 x 79 x 143	• Ø 5-16 — 0-16	320
MT-813-C	21	35 x 79 x 169	■ 40 x 16	330
MT-814/2	14,5	85 x 56 x 192	• Ø 5-28	660
MT-817-C	21	30 x 90 x 140	• Ø 5-16 — 40 x 16	330
MT-814/3	14.5	85 x 56 x 195	• Ø 18-33	620
MT-818-C	14.5	37 x 85 x 155	• Ø 10-32	440
MT-815-C	30	44 x 100 x 180	• Ø 5-35 — 16-40	650
MT-815-E	30	44 x 100 x 180	— 16-40	650
MT-815-S	30	44 x 100 x 180	■ 5-40	650

Recommended stick:
CE-4-21-C / CF-5-90-E / MG-115-S.

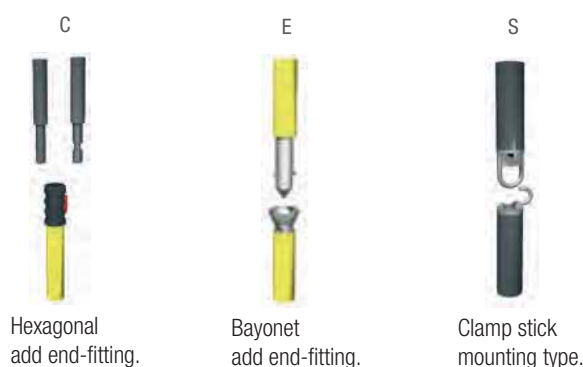

MT-811-C



MT-812-C



MT-813-C



MT-814/2
MT-814/3



MT-815-C



MT-817-C



MT-818-C

Earth clamps

Copper aluminium bronze earth clamps.

Earth cable connection by connector, lug, TO- system...

Reference	Rating (kA/1 s)	Dimensions (mm)	Connection	Clamp capacity (mm)	Weight (g)
MT-840	20	40 x 73 x 135	TO-08 connector 35 mm ²	• Ø 6 -25 — 0 - 25	480
MT-840/1	20	40 x 73 x 135	Thread: Ø 12.5 mm	• Ø 6 -25 — 0 - 25	480
MT-841	30	40 x 73 x 135	Connect. Fontenay ≤ 50 mm ²	• Ø 6 -25 — 0 - 30	480



MT-840



MT-840/1



MT-841



Dimensions



Diameter



Clamp capacity





Weight

NORMAFIX™ access points and clamps for placement on permanently installed fixed points

The advantages of grounding and short circuiting using permanently installed fixed points on existing conductors include:

- Using the same grounding and short circuiting equipment regardless of the conductor shape, section, or configuration
- Accessibility from variable angles
- Eliminating the risk of errors because grounding locations appear at first glance.

Reference	Rating (kA/1 s)	Sphere dimension Ø	Fixing	Conductors (mm)		
MT-951/1	10	18 mm	Bolt: M 10 - L = 25 mm	Flat conductors	90	
MT-951/2			Bolt: M 10 - L = 35 mm		100	
MT-951/3			Bolt: M 10 - L = 45 mm		107	
MT-952/1			Bolt: M 10 - L = 25 mm		110	
MT-952/2			Bolt: M 10 - L = 35 mm		120	
MT-952/3			Bolt: M 10 - L = 45 mm		130	
MT-953/08			Round conductors	Ø 6-8	130	
MT-953/12				Ø 10-12	185	
MT-955/08				Ø 6-8	150	
MT-955/12				Ø 10-12	200	
MT-956				Thread: Ø 12.5 mm	Terminal fitting	75
MT-2951				IEC-61230 	20 mm	Bolt: M 12
MT-2951/1	Bolt: M 12 - L = 35 mm	180				
MT-2951/2	Bolt: M 12 - L = 45 mm	200				
MT-2950/35	Bolt: M 12 - L = 35 mm	247				
MT-3951	Bolt: M 12	240				
MT-3952	Bolt: M 16	240				
MT-3951/1	30	25 mm	Bolt: M 12 - L = 45 mm	-	300	
MT-3952/1			Bolt: M 16 - L = 45 mm		350	
MT-3950/35			Bolt: M 12 - L = 35 mm		300	



MT-953...

MT-955...



MT-956



MT-2951
MT-3951
MT-3952

MT-2950/35
MT-3950/35

MT-2951/1
MT-2951/2
MT-3951/1
MT-3952/1

Access points

To be used with clamps type MT-1911, MT-1921.

Reference	Rating (kA/1 s)	Fixing	
MT-1951/10	20	Bolt: M 10 - L = 35 mm	125
MT-1951/12	20	Bolt: 12 - L = 35 mm	125

Clamps

Reference	Rating (kA/1 s)	Fixing	
MT-920-E	20	For fixed points Ø 20 mm	350
MT-925-E	20	For fixed points Ø 25 mm	400



MT-1951/10
MT-1951/12



MT-920-E



Short-circuiting and earthing systems (installations)

Insulating sticks for substation use

Short circuiting and earthing systems for substation. Telescopic sticks for voltage detectors and earthing systems for use in dry and wet conditions.

Reference	~	∅ mm	↔ Folded	↔	kg
CE-4-21-(*)	90 kV	41/32	1.15 m	2 m	1.5
CM-7-10-A	Rallonge*	36	-	1 m	1
CE-75-(*)	75 kV	41/32	1.15 m	2 m	1.2

(*) Specify type of mounting when ordering: C or K. Delivered with wall mounted support CI-10-D.
* For CE-4-21.

Standard sticks

For short circuiting and earthing system. For use in dry conditions.

Reference	~	∅ mm	↔	g
CF-3-72...-(*)	72.5 kV	36	1.50 m	880
CF-3-90...-(*)	90 kV	36	2 m	1 060

(*) Specify type of mounting when ordering: C or K. Delivered with wall mounted support CI-10-D.

Sticks with skirts

For short circuiting and earthing system. For use in dry conditions.

Reference	~	∅ mm	↔	kg
CF-5-40-(*)	40 kV	36	1.50 m	1.55
CF-5-90-(*)	90 kV	36	2 m	1.55

(*) Specify type of mounting when ordering: C, K or E.

Short length stick

For MV telescopic sticks.

Reference	~	↔	g
CE-3-24-C	20 kV	Insulating Length = 0.52 Overall Length = 0.80 Folded Length = 0.56	370



VPIS and VDS systems for M.V. cubicles

We can deliver complete set with foot capacitance, head capacitance and wirings to your own specifications. Please consult us.





* IEC 61958
** IEC-61243-5



Integrated voltage presence indicating system (V.P.I.S)

Indicates the voltage presence on M.V. cubicles by being installed on the capacitive dividers. Voltage of use behind capacitive dividers: 1 000 V (between phase and neutral). Light threshold: 90 V. Signaling: 3 neons. Attachment: male/female plugs.

Reference	Characteristics	 mm	 g
CL-495-3 *	Delivered complete with connector assembly	130 x 30	85



Diode.



Sound phase comparator. MX-404.

Integrated voltage detecting system (V.D.S)

Indicates the voltage presence on M.V. cubicles by being installed on the capacitive dividers. Voltage of use behind capacitive dividers: 1 000 V (between phase and earth). Light threshold: 70/90 V. Input impedance: 36 MΩ. Signalling by 3 red diodes.

Reference	Characteristics	 mm	 g
CL-497-00 **	Delivered complete with connector assembly	146 x 30	90

Led RED.



Sound phase comparator.

Sound phase comparator

The MX-404 sound phase comparator checks the concordance between 2 phases.

The comparator's operation is indicated by:

Emission of an audible signal when there is discrepancy between the two phases. Absence of an audible signal when there is no discrepancy between the two phases. Power supply: 9 V type 6LR battery.

Reference	Characteristics	 mm	 type 6 LR-61
MX-404 **	Delivered with case	145 x 80	9 V

Discrepancy indication led GREEN.





VPIS and VDS systems for M.V. cubicles

Interface for integrated voltage detecting system (V.D.S)

Indicates the voltage presence on M.V cubicles by being installed on the capacitive dividers. For High impedance detecting systems Input impedance: 36/43 MV. Voltage indication by 4 mm standard sockets on the front of the indicator.

EIC-61243-5



CL-498-00

Voltage indicator by 4 mm standard socket.

Reference	Characteristics	mm	g
CL-498-00	Delivered with connection set	146 x 30	90

Separable voltage detecting system (V.D.S)

This device enables to check the absence or presence of voltage on three phases (L1, L2, L3). HR high impedance. Voltage max: 1 080 V rms. 50/60 Hz. Voltage presence: **RED** flashing LED > 1 Hz. Fits in CL-498 devices.



CL-499/101

Voltage detector.

Reference	Characteristics	mm
CL-499/101	Delivered in plastic bag	145 x 80

Voltage tester for M.V. separable connectors

Voltage detectors and indicators

CE





Voltage tester for M.V. separable connectors 10-36 KV

Checks the absence of voltage on the capacitive terminals of plug-in M.V. bushings. Sensor in the form of a bent finger enabling removal and reinstallation of the terminal insulating cover. Signal via beeping and bright red flashing of electro-luminescent diodes. Built-in function test via the "TEST" button which covers the entire device. Permanent stand-by state. Power supply: four 1.5 V, R-6 batteries. Mounting on insulating stick via a universal end.



Reference	Characteristics	g
CC-151-K	Tester in rigid case with batteries 70 x 100 x 165 mm	700
CC-45-K	Stick to use with the CC-151K. L = 1.25 m	600

Safety lamps

Reference	Characteristics	 mm	 kg
CD-122	Automatic switch on in case of power break Adjustable flood beam - power beam: 5.5 W Operates: 3 hours - IP40 Classe II	240 x 120 x 128	1.8
CD-124	Delivered with a wall mounted support. Operates: 1 hour (12 W), 2 hours (6 W) Rechargeable on 230 V 50/60 Hz	100 x 190 x 220	1.9



Aperture Housing

Compatible with **NF C 13-100**.



Moulded plastic. Installed outside by tightening three screws on a steel clamp.

Reference	 g
CI-70	140



Manœuvring and rescue sticks

White resin polyester/glass fiber foam filled tube.

Reference			 g
CM-45	45 kV	1.50 m	7 500
CS-45 *	45 kV	1.65 m	1 000
CM-90	90 kV	1.85 m	800
CS-90 *	90 kV	2.05 m	1 100
CM-225	225 kV	2.25 m	850
CS-225 *	225 kV	2.45 m	1 350

* Delivered with wall mounted supports.

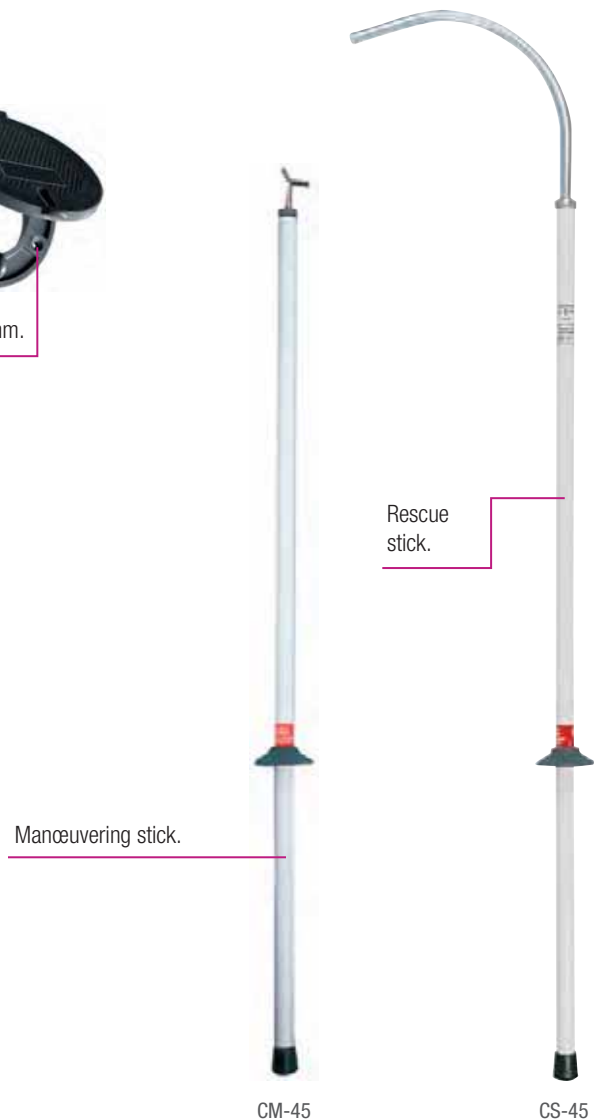



Extra safety equipment and life saving kits

Wall mounted supports

For sticks and voltage detectors. Plastic.

Reference	Top ∅ mm	Bottom ∅ mm
CI-06-D	28-30	36 max.
CI-08	16-20	36 max.
CI-10-D	32-36	58 max.
CI-12-D	28-30	58 max.

Delivered with wood screws.



Rescue hook

Reference	Characteristics	mm	g
CS-01-C	Adaptor C	345 x 335	350

On stick equipped with a "C" end-fitting.



Compact carrying KIT

This compact kit is designed especially to be carried in a vehicle for safety electrical intervention. Made of two parts (of moulded material: PEHD), the red case cover is also an insulating platform.



Reference	Characteristics with instructions in English	~	mm	kg
CZ-53-R	With instructions in English	25 kV	710 x 570 x 240	21
CZ-53-MR	With instructions in English/Arabic	25 kV	710 x 570 x 240	21
CZ-53-R/2	With instructions in English	36 kV	710 x 570 x 240	21
CZ-53-MR/2	With instructions in English/Arabic	36 kV	710 x 570 x 240	21



∅ Diameter mm Dimensions Weight ↔ Total length

Life saving kits for M.V. substations

Wall mounted kit.

Reference	Characteristics			
CZ-54-R	English instructions	24 kV	840 x 754 x 270	21
CZ-54-RM	English/Arabic instructions	24 kV	840 x 754 x 270	21
CZ-55-R	English instructions	36 kV	840 x 754 x 270	21
CZ-55-RM	English/Arabic instructions	36 kV	840 x 754 x 270	21

Insulated cable cutter.
Forged steel blades.
Maximum opening 30 mm.

Insulating boots.

Wall mounted cabinet.

Voltage detector with flexible antenna contact (with autotest).

Close

Open

Safety instructions on the plastic board.

High voltage insulating gloves, insulating boots and talcum powder can.



Insulating platform 24 or 36 kV.

Rescue telescopic stick.



In case of an electrical accident, quick action is essential: by saving seconds, you get more chance to save life. Our life saving equipment is designed to make all necessary equipment immediately available to rescue people.

Insulated cable cutter

Reference		
CZ-60	0.630 m	2.2

Insulated handles 25 kV.

Maxi cable : 30 mm.
Section \approx 150 mm².

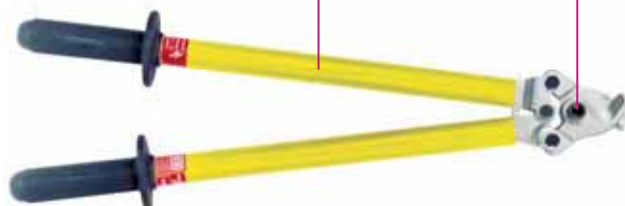

Diameter



Dimensions



Weight



Total length

Medium voltage equipment

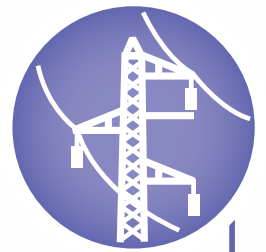

<u>IEC voltage detectors</u>	<u>142</u>
<u>Voltage detectors</u>	<u>143</u>
<u>Single phase comparators</u>	<u>144</u>
<u>IEC equipment</u>	<u>145</u>
<u>Insulating sticks</u>	<u>146</u>
<u>Clamp dispenser heads and accessories</u>	<u>148</u>
<u>Overhead line systems</u>	<u>149</u>
<u>Cables</u>	<u>150</u>
<u>Underground systems</u>	<u>152</u>
<u>Sticks accessories</u>	<u>153</u>



IEC electronic Voltage Detectors, "Compact serie" for indoor and outdoor use

IEC 61243-1
CE

Ultimate technology of voltage detector "Head Capacitive Technology"

Compact and light, it offers a wide band (10/36 kV).

Operating check:





By pressing the TEST button:

- A **RED** LED flashes on.
- Powerful rated audible signal > 60 dB(A)/2 m.
- When loosening the button. The timed **GREEN** LED lights up. While remaining on, it indicates the good working order of the detector.

Characteristics:

- Precise and stable operating threshold.
- High environmental resistance (impacts, vibrations, moisture).
- Temperature conditions: class N (IEC 61243-1 standard).
- Use from 50 to 60 Hz.



Reference				
	Operating voltage (KV)	type 6 LR 61		
CC-765-55/20*	50/60 Hz	5.5 - 20 kV	9 V	350
CC-765-3/10*	50/60 Hz	3 - 10 kV	9 V	350
CC-765-10/36*	50/60 Hz	10 - 36 kV	9 V	350
CC-765-10/30*	50/60 Hz	10 - 30 kV	9 V	350

(*) Specify type of mounting when ordering: C or K.
Packaging: unit supplied complete in a case with batteries and contact electrodes (straight and V-shaped).
Total weight: 1100 g. Total size: 340 x 275 x 83 mm.
For other voltages, please consult us.



End fittings:

C: hexagonal 12 mm, for hexagonal end-fitting sticks,
K: universal, for universal end-fitting sticks.
Recommended stick: **CE-4-21**, **CE-75**.

End fitting C.

End fitting K.

Robust housing.
Weight of the detector: 350 gr.
Size of the detector:
Ø 59 x 270 mm.



Contact electrodes fitted to the housing by screwing and are easily interchangeable.

Voltage presence is indicated by:

- **RED** flashing LED (very bright - visible at more than 20 m in direct lighting),
- powerful rated audible signal > 60 dB(A)/2 m.

NEW Dual voltage range detector : CC-775

This voltage detector is also available with two voltage ranges without a manual selector switch, in compliance with the standard IEC 61243-1.
Example: from 2 to 7 kV & from 12 to 25 kV. **Please contact us in order to determine together your appropriate need in the respect of the standard.**



C 18-311
CE

Standard electronic voltage detector for indoor and outdoor use

Checking

By pressing the test button:

- extremely bright **RED** flashing LED's (visible at more than 50 meters even in unfavourable light),
- powerful rated audible signal > 60 dB/2 m





The test button is released:

- a timed **GREEN** LED lights.

Indicating both the detector is operational and the self testing of the unit continues.

Characteristics:

- Precise and stable operating threshold.
- High environmental resistance (impacts, vibrations, moisture).

Reference		 (operating voltage)	 type 6 LR 61	
CC-365-3/10...-(*)	50 Hz	3-10 kV	1.5 V	500
CC-365-10/30-(*)	50 Hz	10-30 kV	1.5 V	500

(*): Specify type of mounting when ordering: C or K.
Packaging: unit supplied complete in a case with batteries and contact electrodes (straight and V-shaped).
Total weight: 1100 g. Total size: 340 x 275 x 83 mm.
For other voltages, please consult us.

Accessories

Reference	Characteristics
CC-365-101	Flag/Vee contact electrode
C-92-492	Contact electrode for installations L = 310 mm, insulating on 300 mm



Housing
Polycarbonate.
Size of detector
Ø 59 x 390 mm.

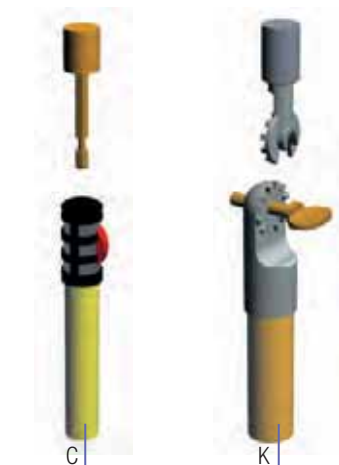

End fittings:

C: hexagonal 12 mm, for hexagonal end-fitting sticks,
K: universal, for universal end-fitting sticks.
Recommended stick: **CE-4-21, CE-75.**

Double signaling:

Voltage presence is indicated by both:

- extremely bright **RED** flashing LED's (visible at more than 50 meters even in unfavourable light),
- powerful rated audible signal > 60 dB/2 m.



Diode **GREEN.**

Single pole phase comparator for indoor and outdoor use

IEC 61481
CE





Unipolar device used to check phase concordance in 2 steps.

- Step 1: storage of the reference phase.
- Step 2: search for the phase in concordance with the one memorised in step 1.

The operator has 15 seconds to complete step 2.

After this time, step 1 must be started again.

Users on 50 and 60 Hz networks.

Reference	 6-18 kV	 type LF 22	 aerial	 850
CL-7-06/18-(*)	6-18 kV	9 V	0.55 m	850
CL-7-10/30-(*)	10-30 kV	9 V	0.90 m	900
CL-7-10/30-1-(*)	10-30 kV	9 V	1.15 m	950
CL-7-12/36-(*)	12-36 kV	9 V	0.90 m	900

(*) Please specify type C or K when ordering.
Delivered in carrying case.

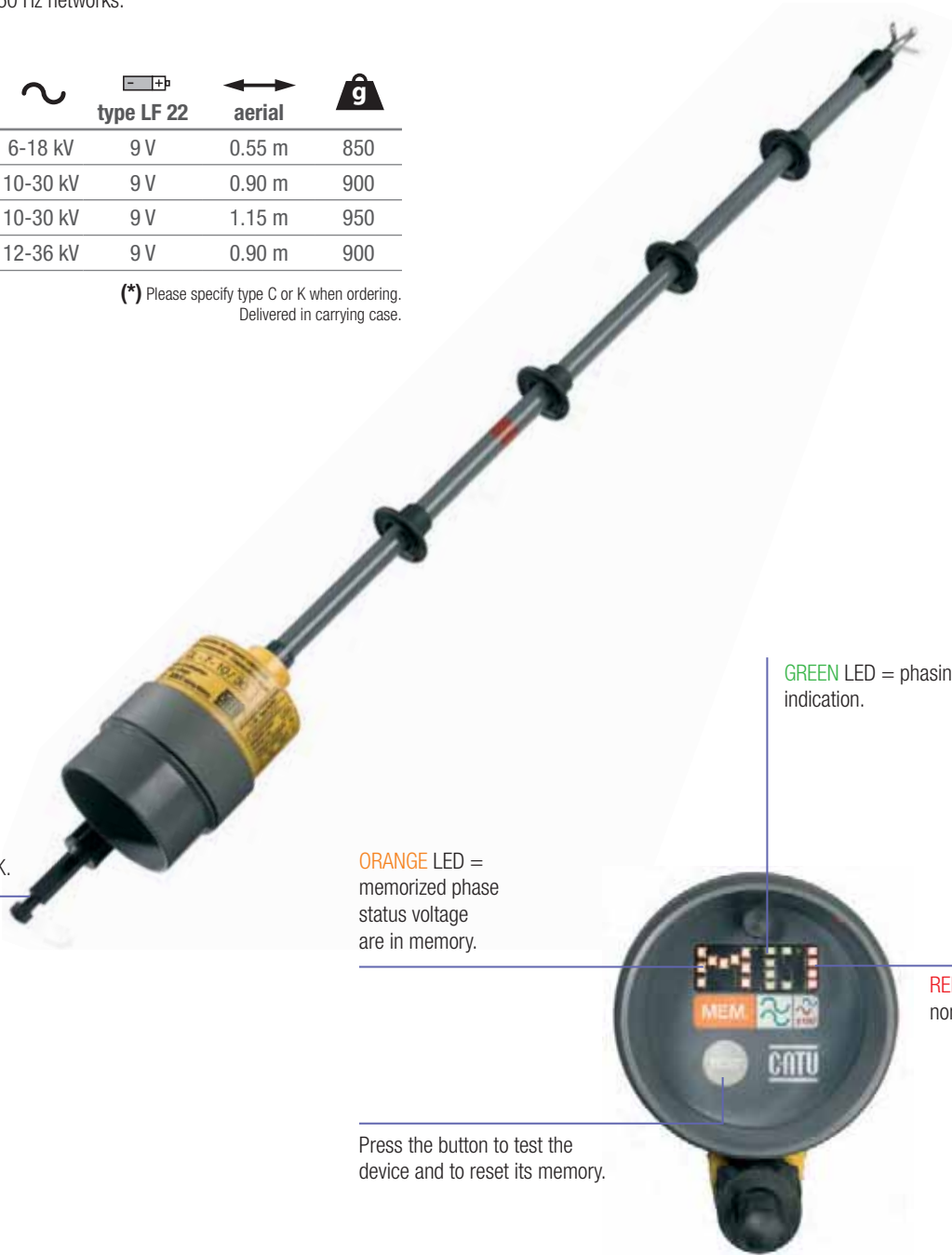

Fixation C or K.

ORANGE LED = memorized phase status voltage are in memory.

GREEN LED = phasing indication.

RED LED = non-phasing indication.

Press the button to test the device and to reset its memory.

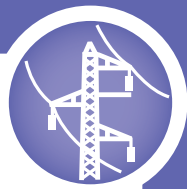

IEC 61230



IEC short-circuiting and earthing systems (three-phase crossarm networks)

MT-613 clamps are automatic contact clamps. They are put into position from above the conductor, using the clamp dispenser head MT-635/1-C.

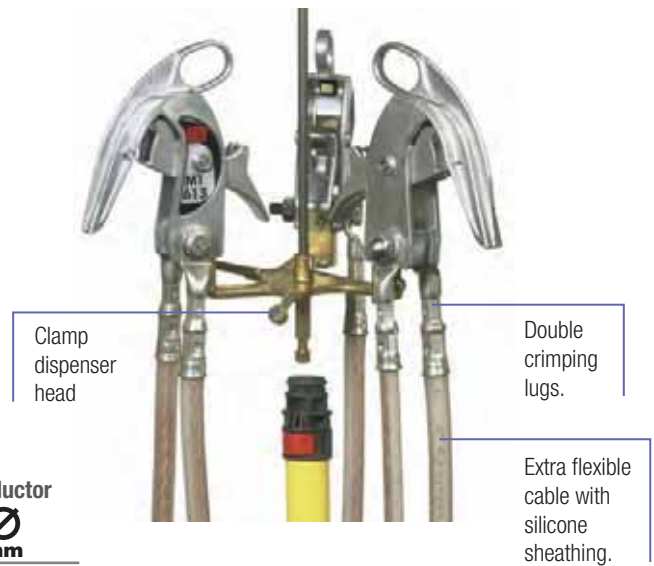
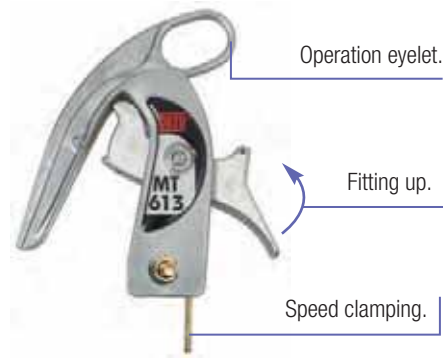

Reference	Equipment composition
MT-6613	3 automatic contact clamps MT-613 Connection cables 35 mm ² , max. gap between clamps: 2.75 m 1 clamp dispenser head MT-635/1-C 1 spool with earthing cable connection MT-640-S 1 carrying bag M-87295
MT-6613/1	3 automatic contact clamps MT-613 Connection cables 95 mm ² , max. gap between clamps: 3 m 1 clamp dispenser head MT-635/1-C 1 earthing cable connection 15 m x 35 mm ² 1 earthing clamp MT-840/1 1 carrying bag M-87295

Characteristics

Reference	Rating (kA/1 s)	Connection copper cable between clamps (mm ²)	Earth connection copper cable (mm ²)	conductor Ø mm
MT-6613 *	8	35 mm ²	16 mm ²	5 to 30
MT-6613/1 **	17.5	95 mm ²	35 mm ²	5 to 30

* Recommended sticks: CE-4-21-C.

** Recommended sticks: CM-4, CF-5, CM-7 et CM-4000.

+ SPECIAL FEATURES

- Remarkable rapidity and ease of handling.
- Removal is carried out by pulling down the clamp, which revolves around the conductor by means of the pig tail fixed in the centre of the clamp dispenser head.

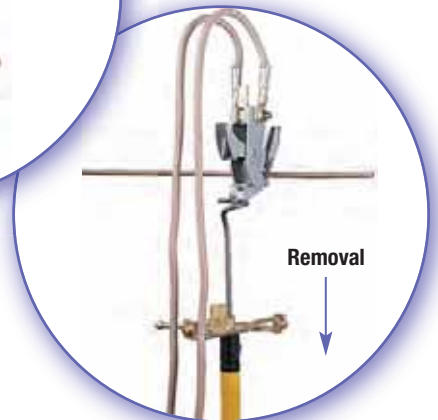

Telescopic sticks for voltage detector

Suitable for wet conditions.

Reference	~	∅ mm	↔ Folded up	↔	kg
CE-4-21-(*)	90 kV	41/32	1.15 m	2 m	1.5
CE-4-30-C	150 kV	41/32	1.75 m	3 m	2
CM-7-10-A	Extension*	36	–	1 m	1
CE-75-(*)	75 kV	41/32	1.15 m	2 m	2

(*) Please specify type C or K when ordering.
Delivered with wall mounted supports CI-10-D.
* For CE-4-21.

Lockable button.

An upper orange element made of glass fiber/resin epoxy foam filled of 32 mm diameter (**).

IEC 61235



Isolated skirts polycarbonate Ø 100 mm, height 90 mm, resistant shocks.

Telescopic stick contains 2 elements made of resin polyester.

Element made of resin polyester/glass fiber.

Element made of glass fiber/resin epoxy foam filled of 36 mm diameter (**).

CM-7-10-A

CE-4-21-C
CE-4-30-C

CE-75-C

CF-5

Yellow lower element made of resin polyester/glass fiber 41 mm diameter base tube.

Fixed length sticks

Suitable for wet conditions.

Reference	~	↔	Skirt nbr	kg
CF-5-40-(*)	40 kV	1.50 m	1	1.15
CF-5-90-(*)	90 kV	2 m	1	1.55
CF-5-110-(*)	110 kV	2.50 m	2	2
CF-5-170-(*)	170 kV	3 m	3	2.4

(*) Please specify type C or K when ordering.

Wall mounted supports

For sticks and voltage detectors. Plastic.

Reference	Top ∅ mm	Bottom ∅ mm
CI-06-D	28-30	36 max
CI-10-D	32-36	58 max
CI-12-D	28-30	56 max
CI-08	16-20	36 max

Delivered with wood screws.

Top



Bottom

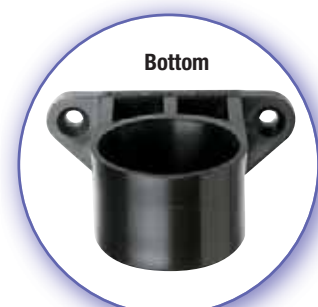



Insulating sticks

Insulating sticks for short-circuiting and earthing systems

This range allows a stick-length limitation in case of space requirements and carrying capabilities.

For common applications a serie of complete sets including 2 or 3 elements are made to give simple solutions for working distance from 2 to 6 meters.

Reference	↔ smallest end fitting	↔ biggest end fitting	↔ isolation	kg
Basic				
CM-4410	1.13 m	–	0.7 m	1.25
CM-4415	1.63 m	–	1 m	1.7
CM-4420	2.13 m	–	1.2 m	2.7
CM-4425	2.63 m	–	1.5 m	3.2
Intermediate				
CM-4410-I	1.165 m	–	0.9 m	1.2
CM-4415-I	1.665 m	–	1.4 m	1.6
CM-4420-I	2.165 m	–	1.9 m	2.5
CM-4425-I	2.665 m	–	2.4 m	3
Terminal				
CM-4410-(*)	1.115 m	1.21 m	0.9-1 m	0.9
CM-4415-(*)	1.615 m	1.71 m	1.4-1.5 m	1.3
CM-4420-(*)	2.115 m	2.21 m	1.9-2 m	2.1
CM-4425-(*)	2.615 m	2.71 m	2.4-2.5 m	2.6

(*) Add end-fitting: B-C-E-H-K-T-D.

Reference	↔ smallest end fitting	g
CM-4400-J	0.362 m	950

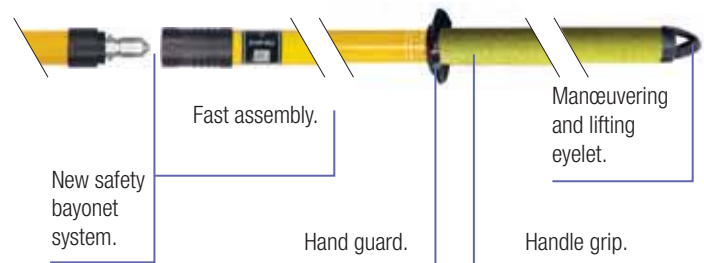
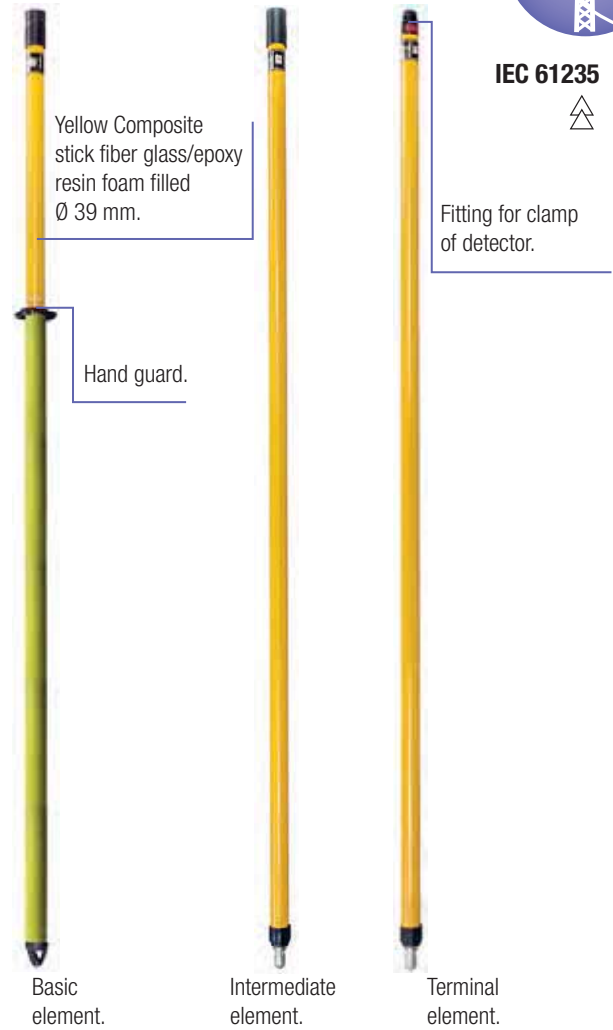

Insulating Stick bags

Strong waterproof canvas cases with a heavy duty zipper closure.

Reference	mm
CM-1-10	1.30 m de Lg
CM-1-15	1.80 m de Lg
CM-1-20	2.40 m de Lg
CM-3-03	0.575 x 1.950 (elmt 1.75 m de Lg)
CM-3-04	0.575 x 2.450 (elmt 2 m de Lg)
CM-3-05	0.575 x 2.850 (elmt 2,50 m de Lg)
CM-3-06	0.575 x 3.400 (elmt 3 m de Lg)

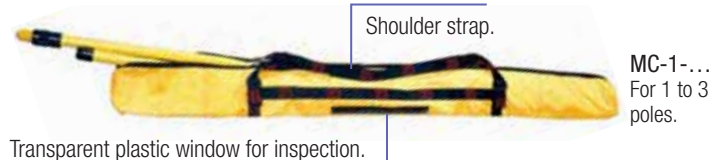

The flared shape allows easy accessories positionning. No need to take them out.

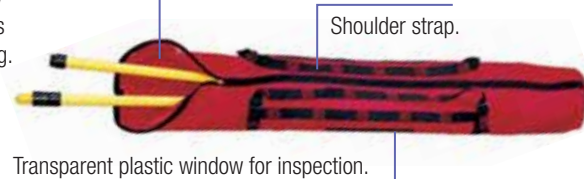

Clamp dispenser heads

Copper aluminium alloy.

For MT-613/1 and 613/2 clamps

Reference	Head for 3 clamps	Head for 4 clamps	With pigtail hook
MT-630-C	■		
MT-630-K	■		
MT-630-S	■		
MT-635/1-C/K/S	■		■
MT-634-C/K		■	

For MT-613/1 and 613/2 clamps

Reference	Head for 3 clamps	Head for 4 clamps	With pigtail hook
MT-633-C	■		■
MT-633-K	■		■
MT-633-S	■		■
MT-634/1-C/K		■	■

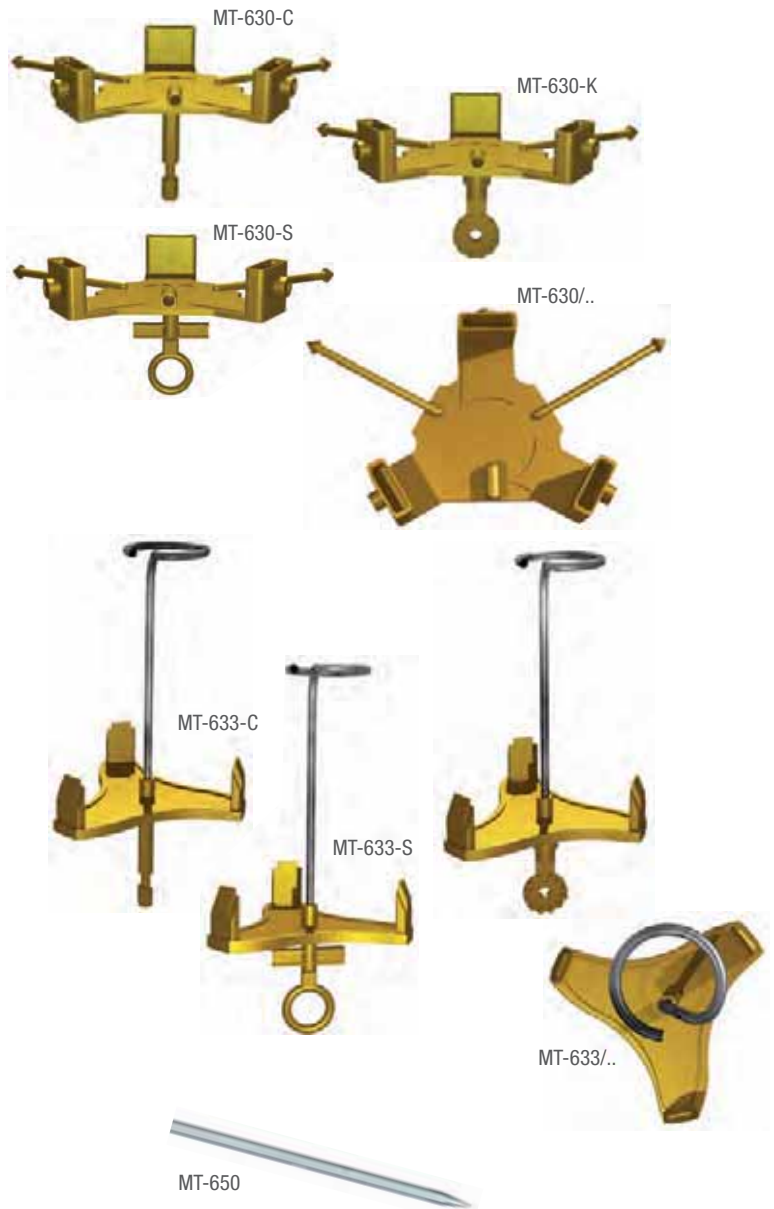

Earth rod

Reference	Characteristics	↔
MT-650	Hexagonal section rod	1 m

Earth clamp

Copper aluminium bronze earth clamps.

Reference	ICC (kA/1 s)	Conductors (mm)	g
MT-840/1	20	Ø 6-25 0-25	480
MT-843	40	Ø 6-35 0-35	950



Spool with earthing connection

Spool with cable and earth clamp.

Reference	Silicone cable (mm ²)	↔
MT-640-S	16	16 m
MT-641-S	16	25 m



IEC 61230



Short-circuiting and earthing systems

Installed from the ground on conductors up to 10.50 m.

Reference	Rating (kA/1 s)	conductor \varnothing mm
MT-508/36	8	3-22
MT-508/46	8	3-22

Reference	Composition
MT-508/36	3 telescopic metallic sticks 3 elements L = 6.00/2.37 m - 2.4 kg - MT-512/36
	1 insulating stick 2 elements 1.65 m - MT-531
	Reel for 3 cables 10 m x 35 mm ² with earth connect. for attachment to stick - MT-543/35
MT-508/46	1 earth rod 1 m - MT-650
	1 bag. 2.50 x 0.30 x 0.15 - 10.5 kg - M-87-127
	3 telescopic metallic sticks 4 elements L = 5.10/1.62 m - 2.1 kg - MT-512/46
	1 insulating stick 2 elements 1.65 m - MT-531
	1 insulating intermediate stick element 1.65 m - CM-4-165-B
	1 stick lifter - MT-546
MT-508/46	Reel for 3 cables 10 m x 35 mm ² with earth connect. for attachment to stick - MT-543/35
	1 earth rod 1 m - MT-650
	1 bag M-87-208

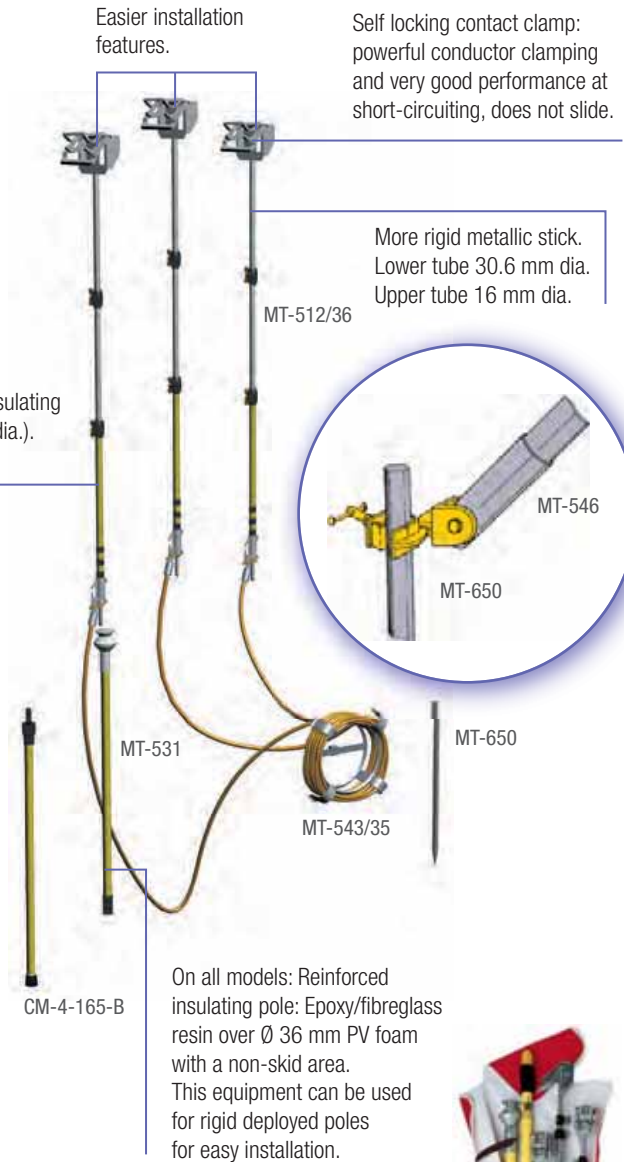

On-the-spot voltage testing with a CC-765 detector attached to a metal pole with a combination Ve/flag antenna.

Medium Voltage Equipment / Overhead line systems

Copper cables

Extra flexible braided multi-strand copper cables.
 Delivered to the meter with a minimum of 5 meters.
 Available in vinyl (A) or silicone sheath (B).

* IEC 61230



Reference		Rating (kA/1 s)	Cable		Section (mm ²)
A	B*		Weight (kg/m)	Ø (mm)	
M-24-10	—	2	0.105	4.5	10
M-24-16	M-24-16-S	3.5	0.156	5.6	16
M-24-25	M-24-25-S	6	0.275	7.5	25
M-24-35	M-24-35-S	8	0.386	9	35
M-24-40	M-24-40-S	10	0.440	9.5	40
M-24-50	M-24-50-S	12	0.545	10	50
M-24-70	M-24-70-S	16	0.768	12	70
M-24-95	M-24-95-S	20	1.000	14	95
M-24-120	M-24-120-S	30	1.280	17	120
M-24-150	M-24-150-S	40	1.630	19	150

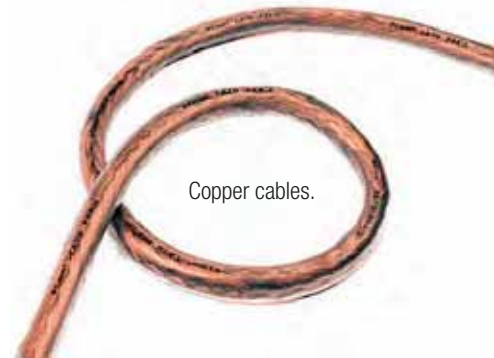

Copper cables only: Heating curves
 (Gut & Grundberg method).

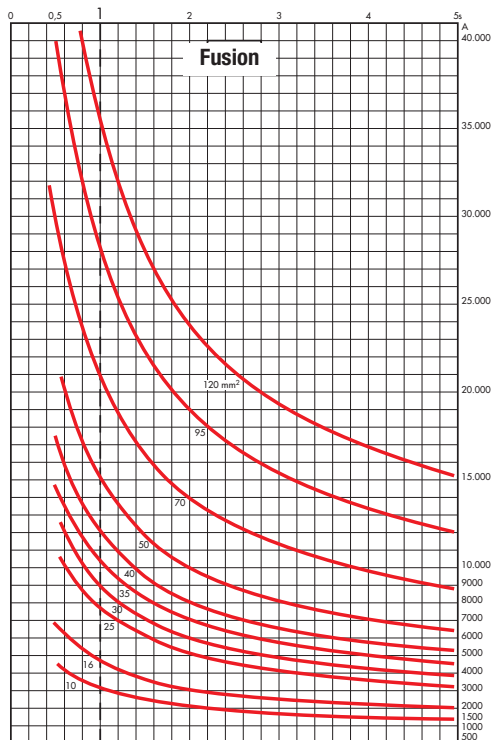

Copper cables only:
 Heating curves - 300 °C.

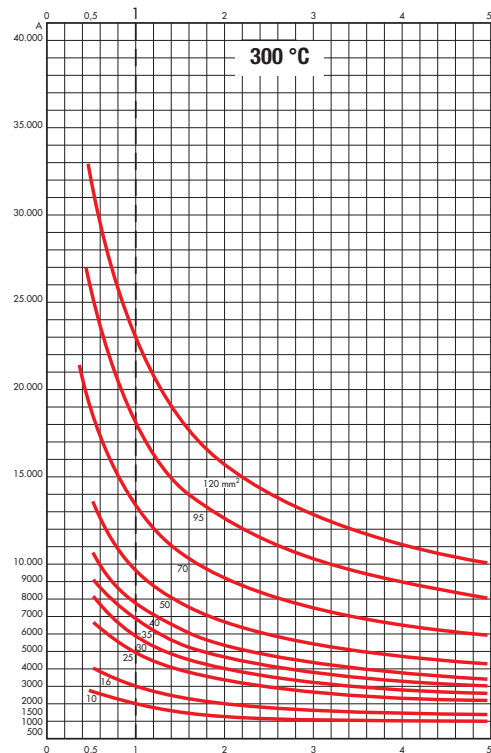



Aluminium cables

Extra flexible braided multi-strand cables.
Transparent PVC sheath, with cable section identification.

Reference	Rating (kA/1 s)	Cable		Section (mm ²)
		Weight (kg/m)	Ø (mm)	
M-28-50	7	0.170	11.5	50
M-28-70	10	0.240	13.4	70
M-28-120	17.5	0.430	19	120
M-28-150	20	0.510	21	150

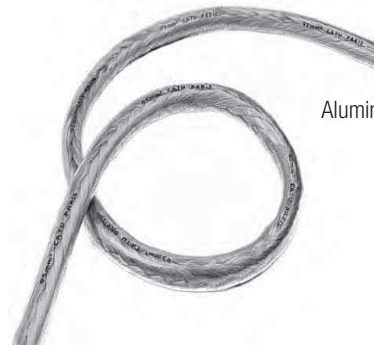

Aluminium cable.

Jumper cables realization specially manufactured items

Assembly consisting of three copper cables or braids for short circuiting, connected to a copper ground wire through a trifurcating box. Transparent PVC sheath.

Reference	Characteristics	Rating (kA/1 s)	kg
MT-40	3 cables 40 mm ² - L = 0.75 m 1 earth cable 40 mm ² - L = 2 m	10	2.3
MT-70/1	3 cables 70 mm ² with equipped lugs - L = 1.20 m 1 earth cable 35 mm ² - L = 2 m	14.5	4.4



Weight

ON REQUEST...CONTACT OUR TECHNICAL ASSISTANCE



We realize specific earthing and short circuiting systems with crimped cables.



Phone: (33) 01 42 31 46 24 • Fax: (33) 01 42 31 46 34 • www.catuelec.com

Cable testing stick

Enables piercing of cable insulation and shielding, earthing up to 50 kV.
Capacity: 70 mm dia.

Reference			
MP-211	1.60 m	Ø 60 maxi	8.75

Carrying Case available separately (MP-02).

Cable-guide with protecting guide. 0.60 m insulating sleeve with 0.80 m extender.

Double cutting angle blade.



Ratchet type operating handle.

Multistrand copper earth wire 70 mm² x 2.50 m with earth clamp.



Insulating blanket

Must be placed over the piercing point

Reference			
MP-212	900 X 900	Ø 50	960

Hole for handle.

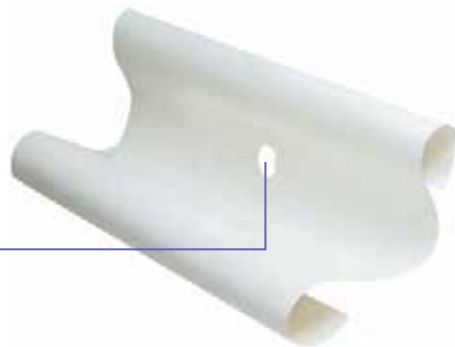

Cable spike equipment

Device to test the voltage on underground cables (1st and 2nd categories) and their earthing, using a system with 9** mm bullet and throwing in the cable a steel treated blade.

Reference	Characteristics	
MP-213 *	Cable spike	20 000
MP-213/LAM	Spare blade for spade-cable MP-213	20
MP-213/EXT	Blade extractor for spade-cable MP-213	200

* Delivered complete in suitcase.

** 9 mm bullet not included and not supplied by CATU.





Connection adaptors for insulating sticks

	C		K		E		S		A ou B			
	hexagonal		universal		bayonet		clamp-stick		"MAJOR" Serie CM-4 / CM-6.			
Accessories												
	C				K				E			
Connection adaptors												
	CI-7-C	CI-3-C	CI-6-C	CI-5-C	CI-3-K	CI-4-K	CI-6-K	CI-7-K	CI-5-K	CI-3-E	CI-7-E	CI-4-E
Sticks												
	E	AB	K	S	AB	C	K	E	S	AB	K	C

With this range any accessory can be attached to any stick by using connection adaptors. Other models, please consult us.

Manœuvering hook

Reference	Characteristics	
CM-02-(*)	Bronze-copper nickel aluminium	120
CM-03-K	Bronze-copper nickel aluminium	120

(*) Add end-fitting: C, E or K.



CM-02-K





CM-02-C



CM-03-K

Cleaning brushes

Reference	Characteristics	 mm	
MD-10-C	Concave brush with two rows of perpendicular bristle	100 x 125 x 170	500
MD-12-C	Round head brush	175 x 228	500
MD-14-C	Adjustable hinged round head brush	175 x 328	500



MD-12-C





MD-10-C



MD-14-C

Trimmer and pruning saw

Reference	Characteristics	 mm	
MD-40-B	Trimmer, maximum capacity \varnothing 45 mm (for branches up to 28 mm depending on tree species)	375 x 240 x 60	1.2
MD-42-B	Pruning saw on rigid frame, 34 cm blade	125 x 610 x 60	1.1
M-92-28	Replacement blade MD-42-B	—	—





MD-40-B



MD-42-B

Fuse puller

All parts in metal protected against corrosion.

Reference	 mm	 mm
CM-04-K	230 x 80	up to 70



CM-04-K



Dimensions



Weight



Diameter

HV lines and switchgear equipment



<u>Voltage detectors</u>	156
<u>Insulating sticks</u>	158
<u>Clamps</u>	159
<u>Earthing system APE</u>	160
<u>Insulating sticks and earth clamps</u>	161
<u>Copper and aluminium cables</u>	162
<u>Accessories</u>	163



AC voltage detector for outdoor use

IEC 61243-1 edition 2*



IEC electronic voltage detector "Ultra Compact Series" for outdoor use.
Ultimate "head capacitive technology" of voltage detector.
Universal application 50/60Hz and wide band of voltage from 44 to 132kV.

Voltage presence is indicated by :

- **RED** flashind led (very bright, visible up to 20 m in direct lighting).
- powerful rated audible signal 67dB(A)/1.5 m.

Operating check :

- by pressing the Test Button, correct operation is indicated by red LED flashing on and a sound signal.
- After realeasing the Test Button, a timed green LED lights on.
- It indicates the good working order of the detector.

Contact electrodes (hook shaped) fitted to the body by screwing and easily interchangeable.

Delivered in a caring bag.

For other voltage, please consult us.

CC-765-44/132



Contact electodes fitted to the housing by screwing and are easily interchangeable.

End fittings



CC-765-44/132-C

End fitting "C": hexagonal male 12 mm on flats, for hexagonal end fitting sticks.



CC-765-44/132-K

End fitting "K": for Universal end fitting sticks.

K end fitting.

Visible light is also indicated on the circumference of the disk for better visibility.

Robust housing thermoplastic

Reference	IEC 61243-1 edition 2	 (Operating voltage)	Contact electrode	Case colour	 type 6 LR 61		
CC-765-44/132	*	44 - 132 kV	Ø 120 mm		9 V	-25/+55 C°	350



Voltage detectors

Ac voltage detector for outdoor use

Precise and stable operating threshold. Insensitivity to induced voltages by limiting the operating voltage range. Remarkably resistant to impacts, vibrations, extreme temperatures, humidity.

Double signaling.

Voltage presence indicated at the same time by:

- 4 bright **RED** flashing electro-luminescent diodes (visible at more than 50 meters even in direct lighting),
- a powerful rated acoustic signal (60 dB/2 m).

The **CC-245** detectors are available according to the models with end fittings:

W: Hexagonal 20 mm,

C: Hexagonal 12 mm,

K: Universal.

Put on "silent block".

IEC 61243-1 edition 2*



Robust housing made from polycarbonate with high mechanical properties and dielectric strength.















Check that the device is working by pressing the TEST button. This tests all of the detector's active components once the TEST button is released.

Surrounded by a rubber impact-resistant padding.

Two **GREEN** illuminated lights, indicating that the device is on. These lights turn off, and four lights illuminate when a voltage is detected.



Reference	IEC 61243-1 edition 2	 (Operating voltage)	Contact electrode	Case colour	 type 6 LR 61		
CC-245-63/90-*	*	63 - 90 kV	Ø 120 mm		9 V	-25/+55 C°	650
CC-245-150-*	*	150 kV	Ø 120 mm		9 V	-25/+55 C°	650
CC-245-225/420-*	*	225 - 420 kV	Ø 200 mm		9 V	-25/+55 C°	650
CC-245-60/150-K or -C	*	60 - 150 kV	Ø 120 mm		9 V	-25/+55 C°	650
CC-245-63/150-*	*	63 - 150 kV	Ø 120 mm		9 V	-25/+55 C°	650
CC-245-90/225-*	*	90 - 225 kV	Ø 120 mm		9 V	-25/+55 C°	650
CC-245-150/420-K or -C	-	150 - 420 kV	Ø 200 mm		9 V	-25/+55 C°	650
CC-245-225/550-K or -C	-	225 - 550 kV	Ø 200 mm		9 V	-25/+55 C°	650
CC-245-315/765-1-K or -C	*	315 - 765 kV	Ø 200 mm		9 V	-25/+55 C°	650

Delivered in synthetic case with handle, battery and electrodes 370 x 165 x 145 mm.

(*) Please specify type of mounting when ordering: C or K.

For other voltages, please consult us.

Insulating sticks for manoeuvring detectors & short-circuiting and earthing systems

This range thus allows a stick-length limitation in case of space requirements and carrying capabilities.

For common applications a serie of complete sets including 2 or 3 elements are providing simple solutions for working distance from 2 to 6 meters.

Reference	↔ smallest end fitting	↔ biggest end fitting	↔ Insulating	kg
Basic				
CM-4610	1.13 m	–	0.08 m	1.35
CM-4615	1.63 m	–	0.33 m	1.8
CM-4620	2.13 m	–	0.33 m	2.8
CM-4625	2.63 m	–	0.83 m	3.3
Intermediate				
CM-4610-I	1.165 m	–	0.8 m	1.3
CM-4615-I	1.665 m	–	1.3 m	1.7
CM-4620-I	2.165 m	–	1.8 m	2.6
CM-4625-I	2.665 m	–	2.3 m	3.1
Terminal				
CM-4610-(*)	1.115 m	1.21 m	0.78 m	1
CM-4615-(*)	1.615 m	1.71 m	1.28 m	1.4
CM-4620-(*)	2.115 m	2.21 m	1.78 m	2.2
CM-4625-(*)	2.615 m	2.71 m	2.28 m	2.7
Fixed sticks				
CM-4115-(*)	1.575 m	1.675 m	0.82 m	1.35
CM-4120-(*)	2.075 m	2.175 m	1.07 m	1.8
CM-4125-(*)	2.575 m	2.675 m	1.32 m	2.8
CM-4130-(*)	3.075 m	3.175 m	1.82 m	3.3

(*) Reference to be completed by fitting: C-E-H-K-T-D.

Reference	↔ smallest end fitting	g
CM-3900-J	0.36 m	950

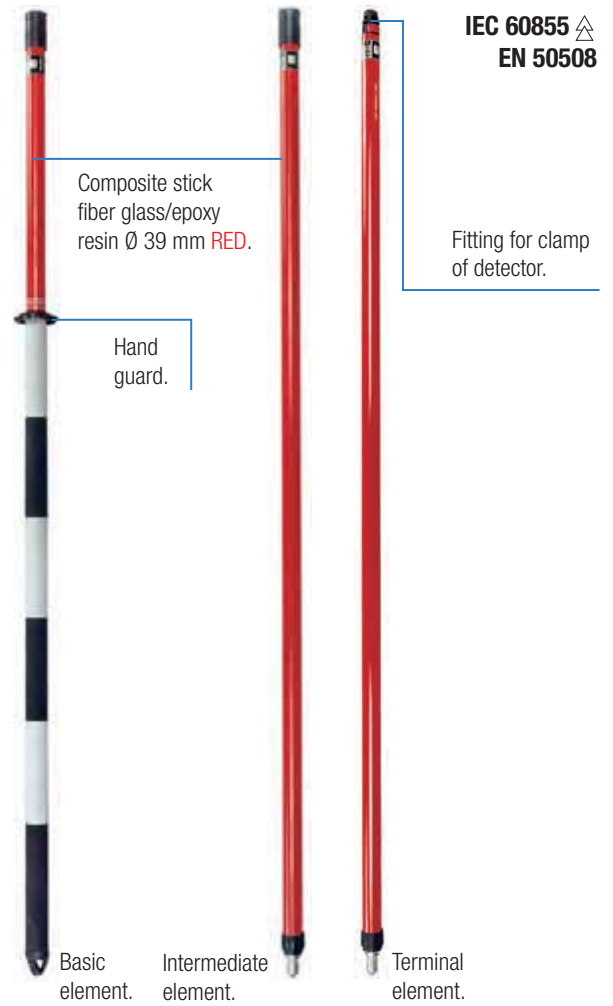
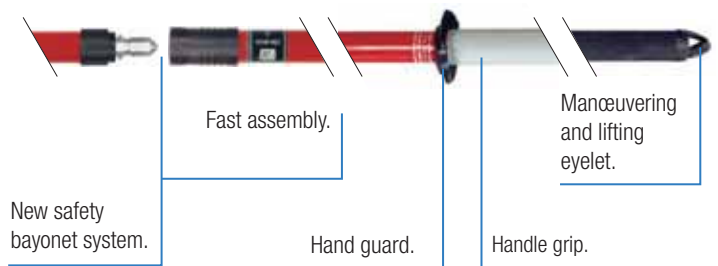

Set of sticks

Complete sets of sticks for common applications.

Reference	Composition	↔
CM-4220-(*)	2 elements : CM-4610+CM-4610-(*)	2 m
CM-4230-(*)	2 elements : CM-4615+CM-4615-(*)	3 m
CM-4240-(*)	2 elements : CM-4620+CM-4620-(*)	4 m
CM-4345-(*)	3 elements : CM-4615+CM-4615-I+CM-4615-(*)	4.5 m
CM-4360-(*)	3 elements : CM-4620+CM-4620-I+CM-4620-(*)	6 m

(*) Reference to be completed by fitting: C-E-H-K-T-D.



HV and EHV clamps manoeuvrable by insulating stick

Body in aluminium alloy with trapezoidal threaded screw. Interposed elastic washers in the clamping system improve efficiency and ensure a higher withstand in case of electrodynamic shock. Manoeuvring by **CM-6** insulated stick of appropriate length and characteristics.



Manoeuvrable clamps	Manoeuvrable clamps								
	MT-732-A MT-731-A	MT-732-B MT-731-B	MT-732-E MT-731-E	MT-732-H MT-731-H	MT-734	MT-734-A MT-735-A	MT-734-B MT-735-B	MT-734-E MT-735-E	MT-734-H MT-735-H

Reference	Rating (kA/1 s)	mm	Copper connection			mm	g
			Copper cables **	Contact range width	Stud		
MT-731-(*)	40	200 x 200 x 50	150 mm ² max.	45 mm	M 12	∅ 5-60	1 450
MT-732-(*)	40	200 x 200 x 50	150 mm ² max.	45 mm	M 12	∅ 40-120	1 450
MT-734-(**)	40	145 x 125 x 52	150 mm ² max.	40 mm	M 12	∅ 5-40	800
MT-735-(*)	40	178 x 175 x 60	150 mm ² max.	40 mm	M 12	∅ 15-60	900
MT-737-H	40	240 x 200 x 55	150 mm ² max.	40 mm	M 12	∅ 20-120	1 350

(*) Add type of connection A - B - E - H.
 (**) Add type of connection B - E - H.
 ** Other cable sections: see page 161 or 162.

Attachment of **MT-735** or **MT-734** clamps with **MT-717-3-B** hook.

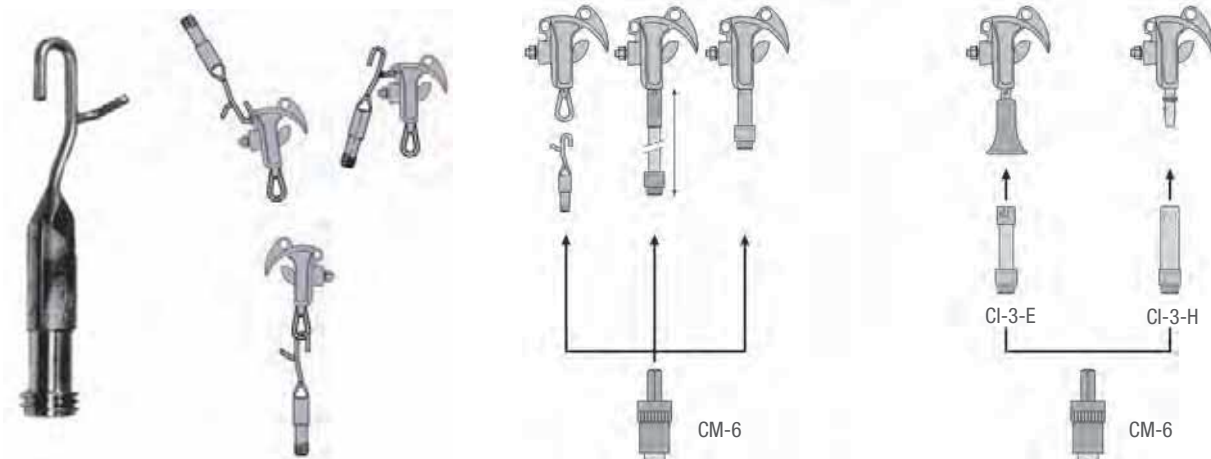

Total length Weight

Earthing system with clamps interlocking

The APE is a grounding system with an interlocking system between earthing and line clamps. It is used for safe and accurate installation (earthing clamp and then line clamp) and removal (line clamp and then earthing clamp).



SPECIAL FEATURES

- Locking system using a patented system with more than 30,000 possible combinations.
- Easy installation and removal without additional accessories.
- Automatic trip at the recommended torque on support withstand the short circuit current.
- System security (unable to be unlocked without the associated clamp).



One reference including 3 phases, so 3 clamps equipped.

Reference	Rating	Use	Fitting	Connection		mm	mm	kg
				Range	Stud			
MT-834-H	31.5 kA/1 s	Substation	H hexagonal	width 38 mm	M 12	360 x 200 x 85	● 5 - 40	3.2
MT-834-E	31.5 kA/1 s	Substation	E bayonet	width 38 mm	M 12	360 x 200 x 85	● 5 - 40	3.2
MT-834-T	31.5 kA/1 s	Substation	T bayonet	width 38 mm	M 12	360 x 200 x 85	● 5 - 40	3.2
MT-835-H	31.5 kA/1 s	Substation	H hexagonal	width 38 mm	M 12	390 x 200 x 85	● 15 - 60	3.48
MT-835-E	31.5 kA/1 s	Substation	E bayonet	width 38 mm	M 12	390 x 200 x 85	● 15 - 60	3.48
MT-835-T	31.5 kA/1 s	Substation	T bayonet	width 38 mm	M 12	390 x 200 x 85	● 15 - 60	3.48
MT-837-H	31.5 kA/1 s	Substation	H hexagonal	width 38 mm	M 12	470 x 220 x 85	● 20 - 120	3.88
MT-837-E	31.5 kA/1 s	Substation	E bayonet	width 38 mm	M 12	470 x 220 x 85	● 20 - 120	3.88
MT-837-T	31.5 kA/1 s	Substation	T bayonet	width 38 mm	M 12	470 x 220 x 85	● 20 - 120	3.88
MT-934	31.5 kA/1 s	Line	ring	width 38 mm	M 12	360 x 200 x 85	● 5 - 40	3.2
MT-935	31.5 kA/1 s	Line	ring	width 38 mm	M 12	390 x 200 x 85	● 15 - 60	3.48



Insulating sticks and earth clamps

Insulating sticks for short circuiting and earthing systems

CM-6 series is recommended for cables $\geq 95 \text{ mm}^2$. Yellow colour elements, with superior characteristics, they are connected between them without any prior order of assembly. These elements allow "long length" assemblies which can support short-circuit systems with large cross-section cables Shockproof guard and pole end cap. Yellow colour elements.



IEC-61235
⚡

Reference	↔	∅ mm	kg
CM-6-15	1.5 m	47	2.4
CM-6-20	2 m	47	3.2
CM-6-25	2.5 m	47	4
CM-6-30	3 m	47	4.8

Earth clamps for over head live networks and substations

Copper aluminium bronze earth clamps.

Reference	Rating	Use	Connection ∅ (mm)	□ mm	⚡ mm	g
MT-843	40 kA/1 s	Substation/ Overhead line	Hole: ∅ 12.5	45 x 106 x 165	• ∅ 6 -25 — 0 - 35	950
MT-843-P	40 kA/1 s	Substation	3 holes: ∅ 12.5	45 x 106 x 165	• ∅ 6 -35 — 0 - 35	950
MT-847	25 kA/0.5 s	Overhead line	Hole: ∅ 13	45 x 106 x 170	— 0 - 30	1000
MT-852	63 kA/0.5 s	Substation	Hole: ∅ 13	70 x 125 x 155	Fixed points	1400
MT-853	40 kA/0.5 s	Substation	Hole: ∅ 13	65 x 130 x 135	Fixed points	1000



Copper cables

Extra-flexible braided multi-strand copper. Delivered to the meter with a minimum of 5 meters. Available in vinyl or silicone sheath.



** IEC-61230
⚡

See page 150.

Equipotential Lines

USE

Conductive line connecting two pieces of metallic pieces in order to give them the same potential.

- Cable composition and features:

35 mm² copper cable insulated in a green silicone sheathing. Double crimped lugs at the cable ends.

Reference	Characteristics
M-24-35-V	Cable 35 mm

- Clamp and stick composition and features:

Insulating stick equipped with a clamp MT-735 in aluminium alloy with Ø 15 to 60 mm clamp capacity.

Reference	Characteristics
MT-735-P4	Clamps MT-735 on stick 400 mm

- Earth Clamp composition and features:

All the earth clamps of page 161 are available to complete the equipotential lines.



IEC-61230



Aluminium cables

Extra flexible braided multi-strand cables. Transparent PVC sheath, with cable section identification.

Reference	Rating (kA/1 s)	Cable		Section (mm ²)
		Weight (kg/m)	Ø (mm)	
M-28-70	10.0	0.240	13.4	70
M-28-120	17.5	0.430	19.00	120
M-28-150	20.0	0.510	21.00	150

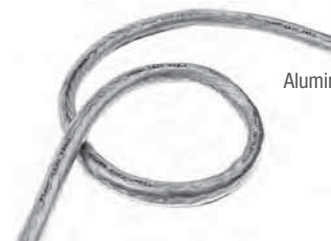

Aluminium cable.

Short-circuiting and earthing system carrying bags

Can receive earthing system equipment (clamps and cables).

Reference	mm	kg
M-87-53	380 x 250 x 400	2
M-87-153	380 x 250 x 600	2.5
M-87-295	550 x 300 x 300	1.5



M-87-295



M-87-53



Adjustable access points

For large vertical or oblique heavy duty conductors.



Reference	Characteristics	Rating (kA/1 s)	mm	Conductor		
				Type	∅ mm	g
MT-790	Copper/Alu alloy ∅ 18 mm	30	255 x 105 x 50	Copper	∅ 12 - 60	1 400
MT-792	Light alloy ∅ 20 mm	30	270 x 105 x 60	Aluminium	∅ 12 - 60	855
MT-797	Light alloy ∅ 20 mm	30	240 x 170 x 60	Aluminium	∅ 60 - 120	1 200

Rope operated clamp

Attachment and removal is carried out from the ground or from the cross-arm, using a rope passed previously over the conductor to be earthed. Up to 10 m: by using MT-709-B reel launcher placed on a CM-6 SERIE Stick (see page 160) that passes the rope over the conductor;
 - up to 20 m: by using a MF-60 wire projector. This projector fires an arrow carrying a braided nylon wire which sets the rope. The clamp is then fixed to the rope and attached onto the conductor.

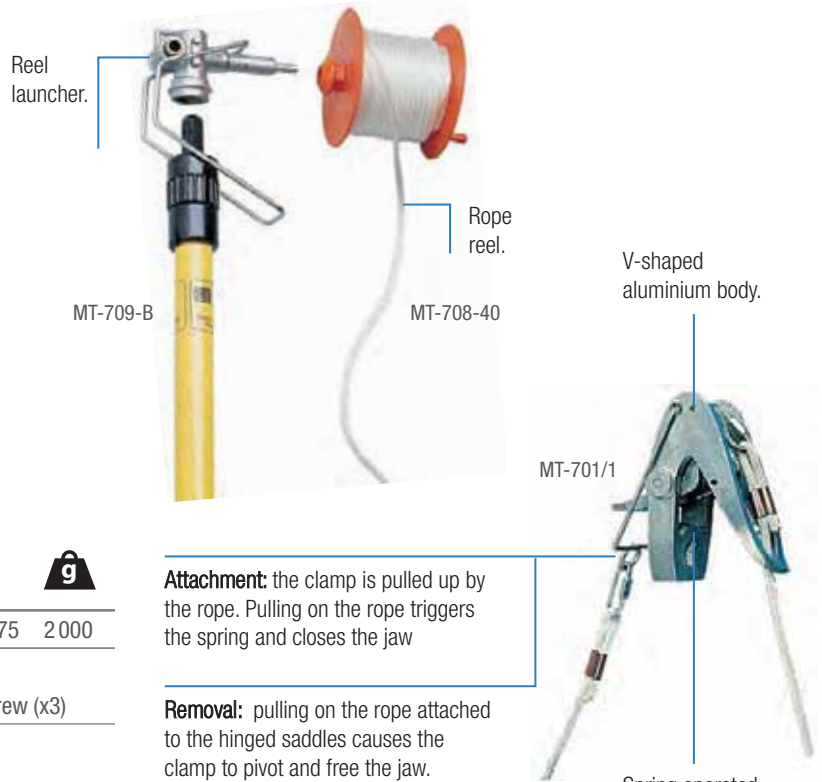

Reference	mm	icc (kA/1 s)	I assym. (A)	mm	g
MT-701/1	∅ 12 - 48	30	72	195 x 120 x 175	2 000

Earthing cable:
 cable 120 mm² with crimped lugs on M12 screw (x3)

Attachment: the clamp is pulled up by the rope. Pulling on the rope triggers the spring and closes the jaw

Removal: pulling on the rope attached to the hinged saddles causes the clamp to pivot and free the jaw.

Wire Gun Tester

An extremely simple way to test the voltage in an overhead line without leaving the ground. Just shoot a weighted arrow over the line - up to 18 m high - forming contact between the conductors through a very lightweight braided steel cable. If they are both live, this produces a sparkover and alerts the user. The MF-60 gun can also be used to shoot an insulating cord for handling MT-701/1 contact clamps.

Reference	Characteristics
MF-60	Complete cable-launcher projector delivered in a waterproof bag with 2 spare arrow and 2 spool of 30 m fuse wire. 3.500 kg.
MF-61	Spare arrow.
MF-62	Spool of 30 m of fuse wire.
MF-63	Spool of 100 m of fuse wire.
MF-66	Spool of 30 m of nylon lead isolated hoisting cord.



OIL & GAS

Offshore installations, shipbuilding,
heavy industry



**The world
of electrical safety**



**Your major supplier for
all your electrical safety equipment needs**

Just contact us !

CATU™

Earthing connections



<u>Earth rods</u>	166
<u>Connectors and earth tester</u>	167
<u>Earth resistance tester</u>	167



General



The rod is, in most cases, the most practical, effective and reliable earth connection means.

Highly effective: for a given contact surface area, the linear type electrode provides, both theoretically and practically, the least earth resistance. Furthermore, it enables the most moist and conductive layers to be reached.

Easy and quick to install, it requires no earth work. Even inside industrial buildings, it is often possible to install an earth rod exactly where required by breaking through a small area of the floor.

Accessible and testable connection: the use of an inspection box makes it possible to leave the head of the rod and its connection unburied and to periodically test it and measure its resistance.

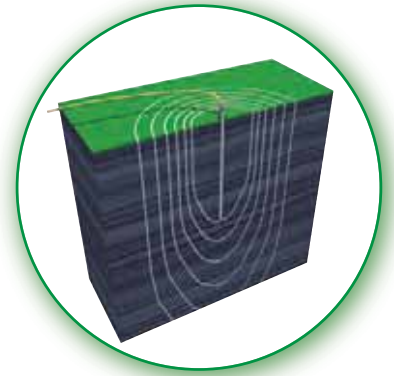

Self connectable rods: The lower end of each rod is equipped with a point used both for driving into the earth and for connection; the upper pierced end receives (without the sleeve) the point of the previous rod. Use a rivetting head so as not to damage the upper end when driving in.

Connectable rods: Conical slide-in provides perfect assembly stability. For deep earth connections.

Copper/Steel earth rods

Steel with copper coating by electrolytic process: Minimum Thickness 250 μ (* = 350 μ).

Standard copper/steel earth rods

Reference	Type	\varnothing mm	\longleftrightarrow	kg	Connection
CC-10-Y	standard with connector	14.2 unit 16	1 m	1.2	BCY
CC-15-Y			1.50 m	1.8	
CC-20-Y			2 m	2.4	
C2C-10-Z (1)	Connectable	17.3 unit 19	1 m	2	C2C-95Z
C2C-15-Z (1)			1.50 m	2.8	

Self connectable Copper/Steel earth rods

Reference	Type	\varnothing mm	\longleftrightarrow	kg	Connection
A3MC-10-Z*	Self connectable	17.3 unit 19	1 m	1.8	TO-3-16/19
A3MC-15-Z*			1.50 m	2.75	TO-2-19 C2C-95-Z
AC-10-Y	Connectable (1)	14.2 unit 16	1 m	1.25	TO-3-16/19
AC-15-Y			1.50 m	1.9	TO-2-16 B
AC-20-Y			2 m	2.5	MCY PI
A2C-10-Z*	Connectable	17.3 unit 19	1 m	1.95	TO-3-16/19 TO-2-19
A2C-15-Z*			1.50 m	1.85	C2C-95-Z C2C-95-Z C2C-95-Z

(1) For connectable models, sleeves and tips are ordered separately.

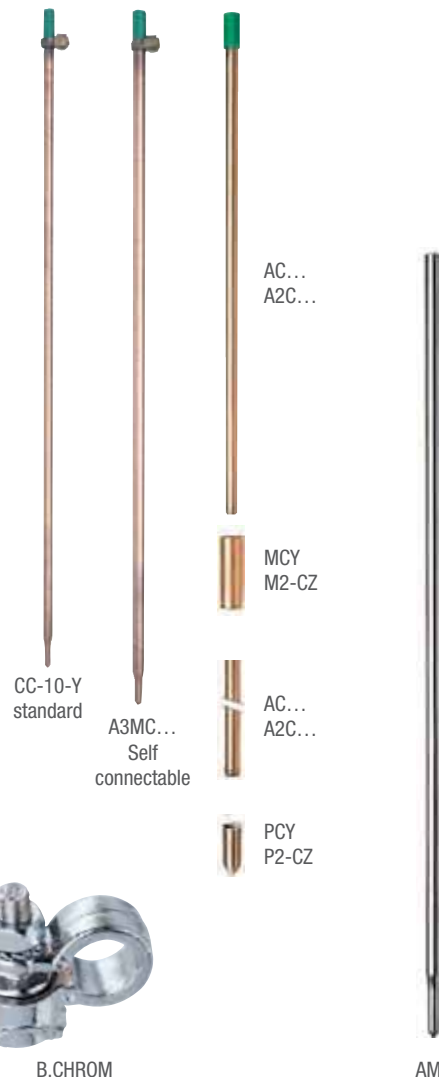

Stainless steel earth rods

Strength steel ≥ 90 daN/mm².

Reference	Type	\varnothing mm	\longleftrightarrow	kg	Connection
AMI-10	Connectable	16	1 m	1.45	B.CHROM
AMI-15			1.50 m	2.2	



AMI

Connectors and earth tester

Connector

Reference	∅ Rod mm	Conductors section max. (mm ²)	Type section max. (mm ²)
TO-2-16	16	40	Copper
TO-2-19	19	40	Copper
TO-3-16/19	19	6 to 95	Copper aluminium alloy
BCY	14.2	95	Copper aluminium alloy
C2C95Z	17.3	95	Copper aluminium alloy



Earthing connector

Interconnects to earth every metallic part of installations.

Reference	Conductors section (mm ²)	mm
COL-8/32	1 x 2.5 to 2 x 6	∅ 8-32
COL-32/100	1 x 2.5 to 2 x 16	∅ 32-100

Reference	mm	kg
CF-1	180 mm	110



Earth resistance tester

The **MX-430-M** allows the measurement of earth resistance and earth specific resistivity and also the parasite voltages caused by grounding parasitic voltage presence.

This equipment is suitable for fast and easy measurement of the grounding resistance in home, industrial buildings, substations,...

Technical features

- **Application:** measurement of grounding resistances (with 3 earth rods), earth resistivity (with 4 earth rods) and parasite voltage presence
- **Range of measurement:** 0 - 20 Ω ; 0-200 Ω ; 0-2000 Ω and 20 KΩ.
- **Voltmeter:** voltmeter function in AC range as a conventional voltmeter 0-200 V AC.
- **Operation frequency:** 1470 Hz.
- **Current in and out put power:** less than 0,5 W and the out put current is limited to less than 15 mA (peak to peak).
- **Operation temperature:** -10°C / +50°C.
- **Storage temperature:** -25°C / +65°C.
- **Humidity:** 95% RH (without condensation).

Reference	mm	kg
MX-430-M	221 x 189 x 99	2

Accessories (measurement kit) MX-433-T

1 storage bag, 4 earth rod copper plated steel, 1 x 5 meter black cable, 1 x 40 meter red cable, 2 x 20 meter cable (1 blue and 1 green), 1 x 5 meter green cable to connect to the grounding system, 1 hammer, 1 reel tape measure 50 m.

Reference	Conductors section (mm ²)	kg
MX-433-T	570 x 220 x 160	7.7



High visibility 3 1/2 digit display with direct readings, even under sunlight.

A smart charger is microprocessor-controlled and can be powered from the mains by a power plug provided source or from a 12 V car battery.

Connexion wire including a 12 V car battery.

Accessories included:

Storage bag.

Battery charger 220-240 V.

Connection wire to supply the charger with a 12 V battery.

LIVE WORKING TOOLS



Since the second world war, CATU has worked in close co-operation with EDF and RTE to research and develop safety equipment and practices for use on low and high voltage networks, initially in France and now worldwide.

Utilities would be better off efficiency of their networks by avoiding outages, whatever the costs. With the increasing recognition of EDF-Serect worldwide, CATU is fast becoming a major supplier in liveline working equipment. All the tools meet the specifications of the International Electrotechnical Committee (IEC).

CATU tools have a liveline life of around 20 years.

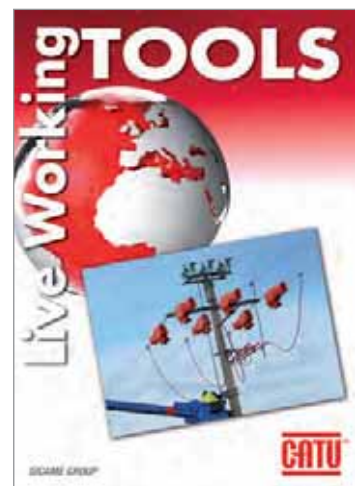

Catalogue available upon request.

Golden safety rules for short-circuiting and earthing system

SEPARATE THE WORK AREA FROM ALL POSSIBLE SOURCES OF POWER-SUPPLY by opening circuit-breakers, switches...

1



2

LOCK THE LINK IN THE OPEN POSITION with a safety lock system (safety padlock)

CHECK THE ABSENCE OF VOLTAGE at source and on site, on each conductor and apparatus involved.

3



4

APPLY APPROPRIATE SHORT-CIRCUIT AND EARTHING SYSTEMS in sufficient numbers on the conductors of your network where operation is taking place.

SHOWN, WARN OTHERS AND LIMIT THE WORK AREA even during the most simple temporary maintenance operation

5





Choose your gloves size!

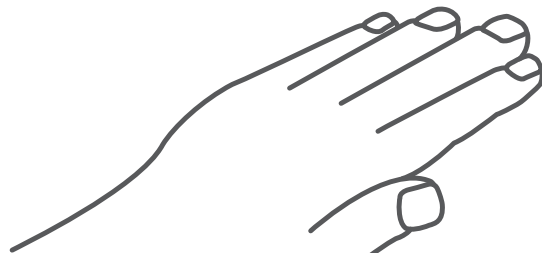

1 Stretch out your hand.

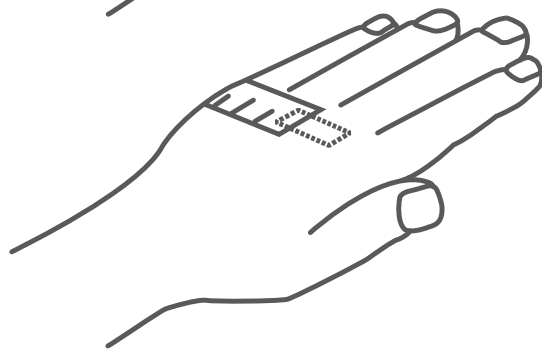

2 Wind the tape measure around your hand at the level of your knuckles. You can position the tape easier by taping it on the top of your hand.

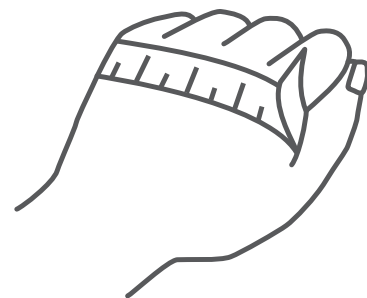

3 Slightly fold your hand without clenching your fist and take the measurement. If you are between two sizes, take the biggest one.

Women gloves size

Inch	6	6 ^{1/2}	7	7 ^{1/2}	8
cm	15.2	16.5	17.8	19	20.3
Sport size	XS	S	M	L	XL

Man gloves size

Inch	7 ^{1/2}	8	8 ^{1/2}	9	9 ^{1/2}	10
cm	19	20.3	21.6	22.9	24.1	25.4
Sport size	XS	S	M	L	XL	XL

Print this page and cut out the ruler.
Ensure that the tape measures ten inches
or 27.90 cm once printed
(scale of your printer = 100%).

IMPORTANT
In the window of the printer's settings,
check that the "scaling" drop-down
menu is set to: "none".

Specification

for short-circuiting and earthing system

A Network, electrical installation characteristics

Network voltage: _____ kV Max. short-circuiting current (1s): _____ kA
 Nature of the conductive materials: Basis Al Basis Cu

Overhead lines Switchboard or substation

- Dia. or section of the conductors: min. _____ max. _____
- Round bars dia. (mm): mini. _____ max. _____
 Length = _____
 Thickness = _____
- Flat bars
 $\left\{ \begin{array}{l} \text{H type} \\ \text{V type} \end{array} \right.$
 H type V type
 Length = _____
 Thickness = _____
- Fitting on edge face Fitting on side face

B Characteristics of the earthing system

- Selected sketch (out of the three standard types shown below)
- Distance between live conductors (m): _____, between live conductors and grounding point (m) _____
- To place the clamps in position, the operator will stand: above the conductors under the conductors
 at the conductors level
- For cable sections, please indicate max. ΔT or min. dia. of the conductor _____

C Earthing connection point

- Earth rods: dia. or thickness on side face (mm): _____ Flat bar, angle-bar, thickness (mm): _____
- Round conductor dia. (mm): _____

D Operating stick

- Insulating stick: total length _____ Fixed Connectable stick Telescopic

Characteristics

- Selected connection type: Sketch n° _____
- Contact clamps (type MT- _____)
- Short-circuiting cable
 - Length (m) _____
 - Dia. or section (mm, mm²) _____
- Grounding cable
 - Length (m) _____
 - Dia. or section (mm, mm²) _____
- Connection of cables on clamps, earth clamps, trifurcation
 - Direct connection by screw and nut
 - Connection by means of crimped lugs
- Earth clamp, type _____
- Presence of a reel _____
- Insulating stick, type _____

Sketch N°1



Sketch N°2

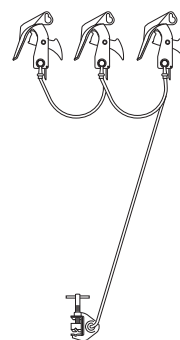

Sketch N°3

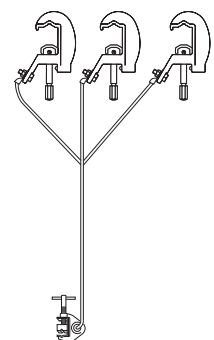

Accessories

- Carrying bag for sticks
- Canvas bag for equipment
- Carrying case for equipment
- Cable reel

Choose

your harness size!

Harness size board (in mm)

Reference	Chest (A)	Size (B)	Thigh (C)	Height (D)
S	700 - 1000	750 - 1000	500 - 700	600 - 750
M	800 - 1200	900 - 1200	550 - 750	750 - 850
XL	1000 - 1500	1000 - 1350	550 - 900	700 - 950

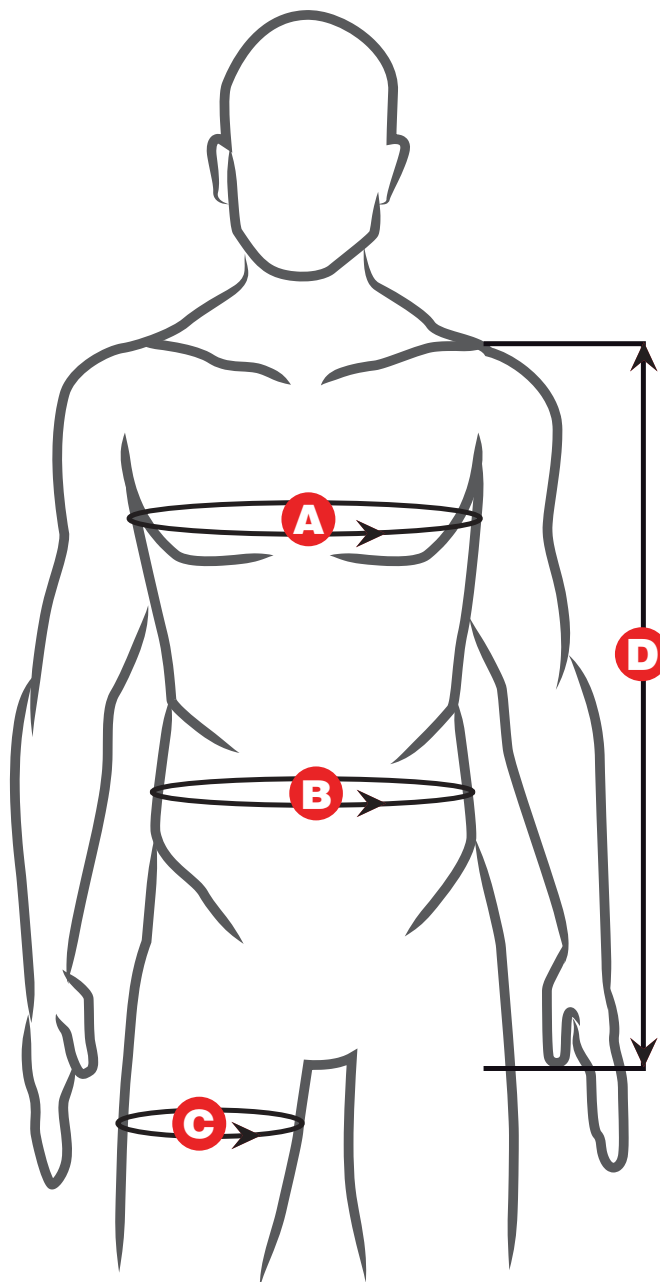

Note

A series of 20 horizontal dotted lines for writing notes.

Note

A series of horizontal dotted lines for writing notes.

The characteristics and technical informations stated in our literature are only for your guidance and therefore cannot be considered as contractual.

Our company is entitled to modify at any time the characteristics of its equipment.
In case of modification of these characteristics, our company would not be obliged to supply materials conform to those previously in force.

“Alu-Metal, Alu-Script, Catex, Catohm, Catu, Catumètre, Clipblock, Detex, Detex-Lumifix, Identex, Isomil, Isostop, Normafix, Pointest, Piezo-Test, Pelican 2, Triplix” are trade marks of Catu S.A.

Non contractual photographs



© 2014 CATU S.A. BAGNEUX
All reproduction, adaptation and translation rights reserved for all countries.

Design / direction / layout: COMST - www.comst.fr

GENERAL CATALOGUE RG-12

Distributed by:



10/20 Avenue JEAN-JAURÈS - B.P.2 - 92222 BAGNEUX CEDEX (FRANCE)
Phone: (33) 01 42 31 46 00 - Fax: (33) 01 42 31 46 32
Phone business: (33) 01 42 31 46 46

www.catuelec.com



SICAME GROUP