

B2N10H-Q20L60-2LI2-H1151

Inclinometer

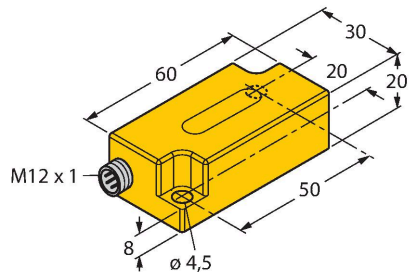

Features

- Plastic, PC
- Zero point calibration $\pm 5^\circ$
- Two analog outputs
- M12 x 1 male connector

Wiring diagram

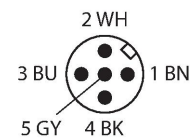
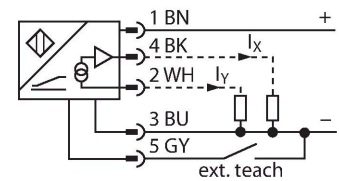

Functional principle

Inclination is determined by a wear-free semiconducting sensor element.

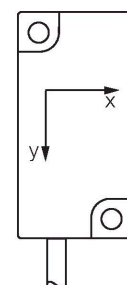
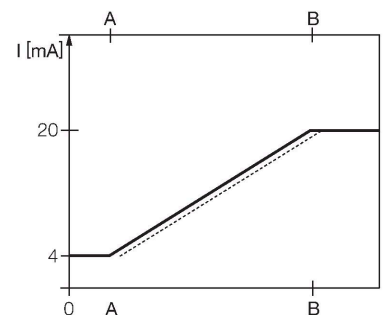
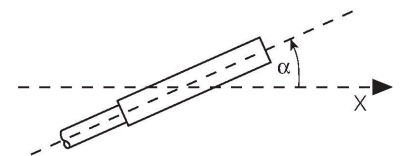

Technical data

Type	B2N10H-Q20L60-2LI2-H1151
ID	1534012
Measuring principle	Acceleration
General data	
Measuring range	$-10 \dots 10^\circ$
Measuring range x-axis	$-10 \dots 10^\circ$
Measuring range y-axis	$-10 \dots 10^\circ$
Number of measuring axes	2
Repeatability	$\leq 0.2\%$ of measuring range $ A - B $
Linearity deviation	$\leq 1\%$
Temperature drift	$\leq \pm 0.05\%$ / K
Resolution	$\leq 0.04^\circ$
Electrical data	
Operating voltage	10...30 VDC
Isolation test voltage	≤ 0.5 kV
Short-circuit protection	yes
Wire breakage/Reverse polarity protection	no / yes
Output function	5-pin, Analog output
Current output	4...20 mA
Load resistance current output	≤ 0.2 k Ω
Response time	0.1 s
	time for the output signal to achieve 90% full scale if the angle changes from -10° to $+10^\circ$
Current consumption	50 mA
Mechanical data	
Design	Rectangular, Q20L60

Technical data

Dimensions	60 x 30 x 20 mm
Housing material	Plastic, PC
Electrical connection	Connector, M12 × 1
Environmental conditions	
Ambient temperature	-30...+70 °C
Vibration resistance	55 Hz (1 mm)
Shock resistance	30 g (11 ms)
Protection class	IP68 IP69K
MTTF	203 years acc. to SN 29500 (Ed. 99) 40 °C

Mounting instructions

Mounting instructions/Description

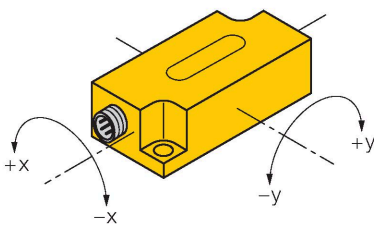

Teaching

The zero point can be adjusted with teach adapter TX1-Q20L60. Teach-GND is pressed for approx. 1 s to do this. The outputs are switched to 20 mA as confirmation. Teach-GND is pressed for 6 s to reset the axis zero points. The outputs are switched to 4mA as confirmation. Once the teach button is released, the sensor returns to normal operation.

Accessories

GUARD-Q20L60

A9684

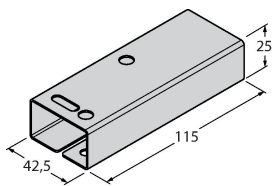

Protective housing for Q20L60 inclinometers for protecting against mechanical impact; material: Stainless steel

Accessories

Dimension drawing	Type	ID	
-------------------	------	----	--

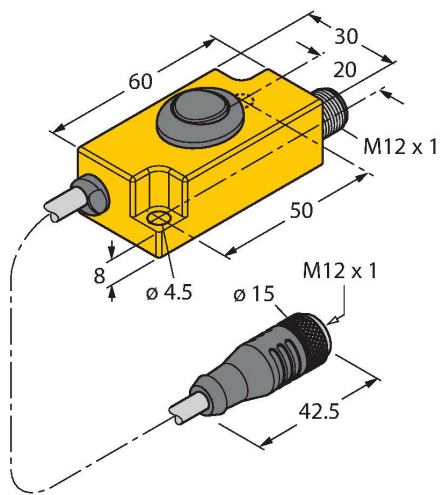

TX1-Q20L60

6967114

Teach adapter for inductive encoders, linear position, angle, ultrasonic and capacitive sensors