

Graphic Dual Axis Mode

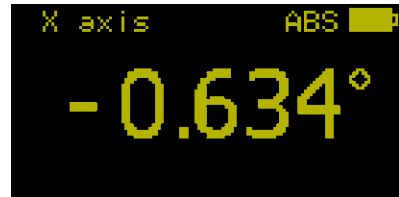

Dual Axis Mode



Single Axis Mode

Description

The IDS is a high quality display system for use with many of our inclinometer sensors. It has a sturdy Aluminium housing which is sealed to IP67 and utilises high performance sealed locking connectors. It has a graphical OLED display for high contrast and wide viewing angle. This enables it to have an extended temperature range (compared with LCD displays), and can be used in low light or night-time applications. It has a built in Li-Ion battery which can power the unit and the attached inclinometer sensor for 30 hours between charges. The display can be switched between single axis, dual axis and graphical measurement modes, and the displayed angle can be configured with one, two or three decimal places. It is supplied with a mains charger, which is also fitted with a sealed connector. Without the battery fitted, the charger will power the device directly. It has an RS232 interface and a versatile programmable alarm function with switched relay outputs.

Features

- OLED Graphical Display. High contrast with wide viewing angle.
- Single, dual axis or graphical display mode
- RS232 interface for onward connection
- Programmable alarm function (relay output)
- Built in Li-Ion rechargeable battery (30 hours continuous use)
- Compatible with many of our inclinometers
- Display resolution 0.001° (adjustable to 1, 2 or 3 decimal places)
- Sturdy aluminium Housing, sealed to IP67 with IP67 locking connectors
- Operating temperature -20 to +70°C (-40 to +85°C without Li-Ion battery)
- Absolute and Relative measurement
- Hold button to freeze current reading



Product Features

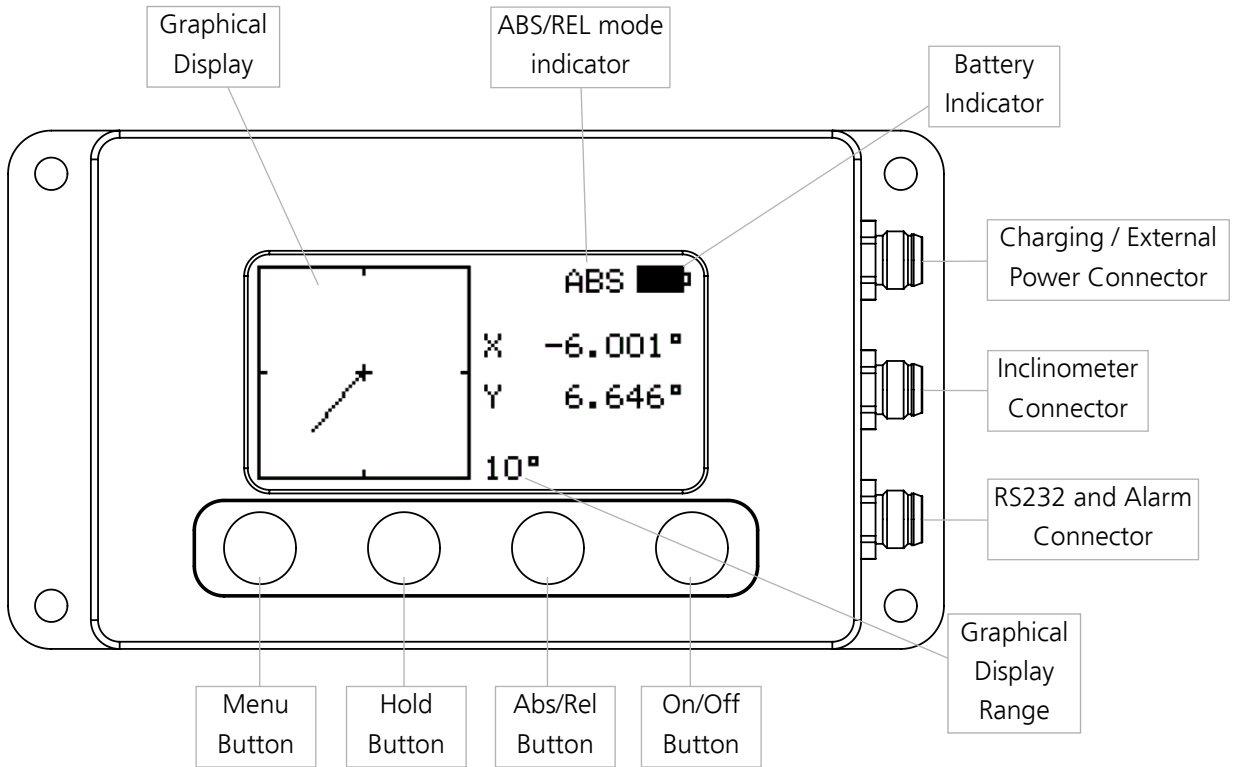

RS232 Interface

The display unit has a full duplex RS232 interface to enable connection to other devices. The RS232 interface is available through the third connector (the 6 pin connector). Pins 1-3 are used for the RS232 connection as detailed in the table. This connector is also used for the alarm relay output (pins 4-6). The RS232 output format can be configured from the menu (see instructions) to change the BAUD rate, and select if the device transmits continuously, or in response to a command. The connection socket on the display unit for the RS232 connection is a 6 pin Binder 768 series M8 panel plug. A range of pre-moulded leads are available and can be purchased from us separately.



2m RS232 Cable : EL-CAB-M8X6FS-DB9F-2
 5m RS232 Cable : EL-CAB-M8X6FS-DB9F-5

Pin	Function
1	RS232 Tx
2	RS232 Rx
3	RS232 Gnd
4	Relay Com
5	Relay NO
6	Relay NC

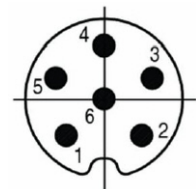

Display RS232 Plug



Programmable Alarm Relay Output

The display unit incorporates a programmable tilt alarm function. The alarm can be programmed to operate when a certain angle is reached in either the X axis, Y axis, or in omni directional mode. The parameters for the alarm can be set from the menu options, please see the instructions for more details. When the preset angle threshold is exceeded, the alarm will switch a relay inside the display unit. The single pole double throw relay connections are available through the third connector (the 6 pin connector). Pins 4-6 are used for the alarm relay as detailed in the table. The connection socket on the display unit for the alarm connection is a 6 pin Binder 768 series M8 panel plug. A range of pre-moulded leads are available and can be purchased from us separately.



M8 Straight Female 6 pin, 2m PUR cable : EL-CAB-79-3464-52-06



M8 Straight Female 6 pin, 5m PUR cable : EL-CAB-79-3464-55-06

Pin	Function
1	RS232 Tx
2	RS232 Rx
3	RS232 Gnd
4	Relay Com
5	Relay NO
6	Relay NC

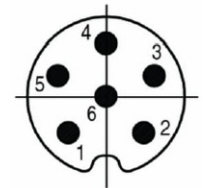

Display Relay Plug

External Power Supply and Charging Connector

The charger and power supply unit supplied is a universal type with an input voltage of 100-250Vac @ 50-60Hz and an output voltage of 12Vdc. It is supplied with a range of adaptors so it can be used in the UK, Europe, the USA and China. The correct adaptor will be sent based on the shipping location.

The charge/power connection socket on the display unit is a 3 pin Binder M8 (768 series) panel mount plug. The external power adaptor supplied with this unit has the equivalent mating connector.

Alternative power supplies can be used to charge or power the IDS, between 9V and 30Vdc with a minimum power rating of 6W.



Straight Connector
3 Pin : EL-CON-99-3400-00-03

Pin	Function
1	+ve Supply
3	0v
4	Not Connected

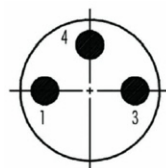

Display Charge Plug



Inclinometer Connector and Connection Details

The connection socket on the display unit for the inclinometer connection is a 4 pin Binder 768 series M8 panel plug. If the display unit is ordered with an LCH or SOLAR-2 type inclinometer sensor, the sensor will be supplied fitted with the mating connector. There are also a range of pre-moulded leads available which can be purchased from us separately.

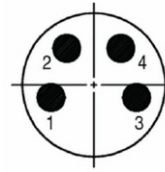

Pin	Function
1	+12v Supply
2	Ground
3	RS232 Rxd
4	RS232 Txd

Display Inclinometer Plug



M8 straight female 4 pin connector
EL-CON-99-3376-00-04



M8 straight female 4 pin, 2m PUR
cable : EL-CAB-79-3382-52-04



M8 straight female 4 pin, 5m PUR
cable : EL-CAB-79-3382-55-04

Protective Carry Case

The display is supplied with a padded carry case for protection in every day use.



Product Options

1. Display can be supplied without charger and carry case for OEM applications
2. Can be supplied with alternative branding for OEM customers or re-sellers.
3. Custom cabling can be pre-assembled for customers application.
4. Can be supplied with or without Lithium-Ion battery (see part numbering)
5. Graphical display configuration can be changed to suit customers requirements.

Special order versions are generally only available for volume orders or ongoing requirements.



Dimensions - Flange Type

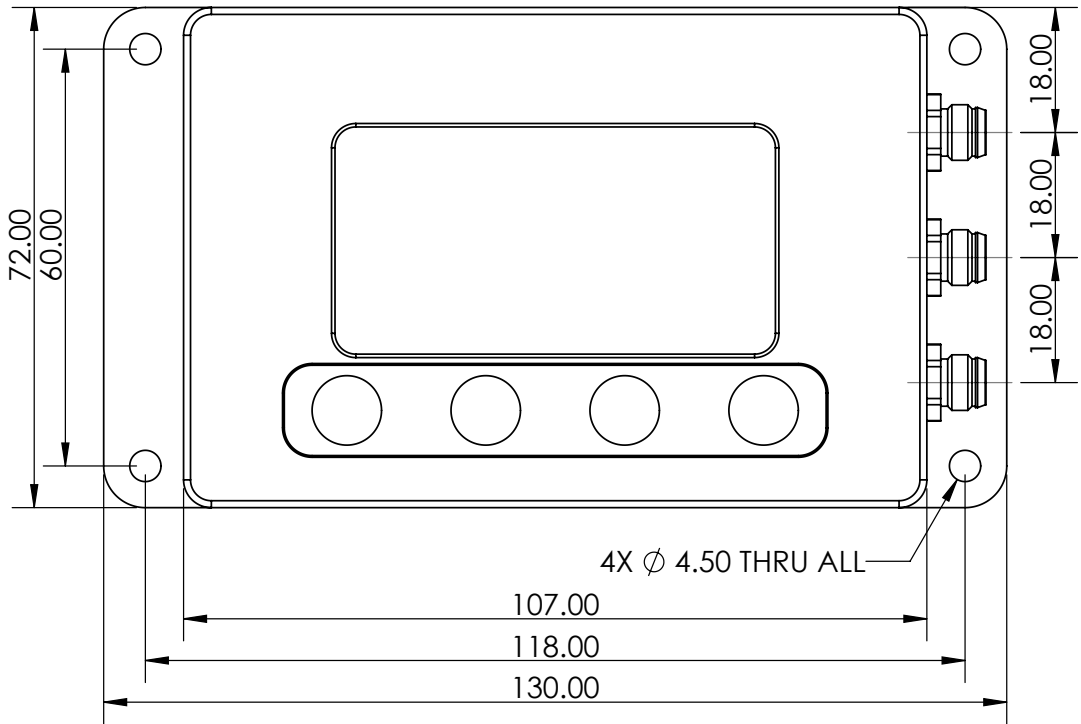



Software

A free Windows based application for reading and logging the angle is available from our website. It requires Windows XP SP3, Windows 7 or Windows 8, and works with 32 and 64 bit systems. It also requires the .net framework V3.5 or higher, and will prompt you to download and install this from Microsoft if it is not already installed on your system. A COM port is also required, and can either be a built in COM port, or a USB to Serial COM port.

The basic features are shown below:

- Automatic or manual configuration of COM port parameters
- Compatible with single or dual axis sensors
- Adjustable number of decimal places on displays
- Logging of data at specified intervals into CSV file

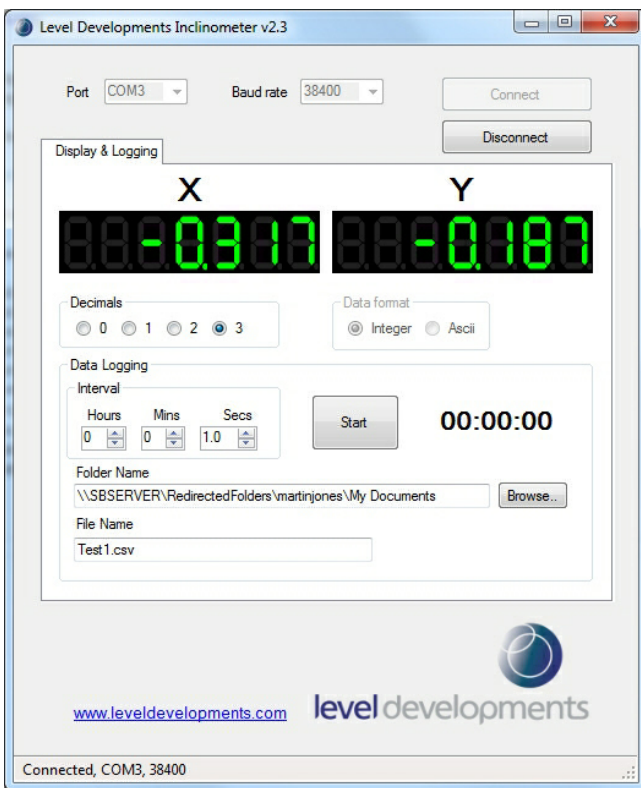

We can also offer custom software development services, please contact us for further information.

This software is provided 'as-is', without any express or implied warranty. In no event will the authors be held liable for any damages arising from the use of this software.



Compatible Sensors

The display is compatible with all of our inclinometers that use the standard Level Developments communication protocol over RS232. These sensors include the models listed below:



LCH-45 and LCH-360

- Dual Axis, $\pm 45^\circ$
- RS232 interface
- Low cost (<£25 for 1kpcs)
- Small size, 46 x 43.5 x 13.5mm
- Anodised Aluminium housing Sealed to IP67
- Braided screen 4 core PUR cable
- CE certified and RoHS compliant.



SOLAR-2 and SOLAR-360 Series

- Dual axis measurement range from ± 5 to $\pm 45^\circ$
- High resolution and accuracy
- Low temperature drift
- RS232 and RS485 interface
- Tough sealed anodised aluminium housing (IP67)
- CE certified and RoHS compliant.
- Braided screen 4 core 3m PUR cable
- Small size, 75 x 37.5 x 12.5mm and light weight



HPS Series

- Single axis measurement from ± 5 to $\pm 60^\circ$
- High resolution and accuracy.
- Excellent temperature and bias stability
- RS232 and RS485 output versions.
- High precision 316 Stainless Steel IP67 housing
- CE and FCC certified and RoHS compliant.
- IP67 Sealed locking M8 connector
- Small size, 70 x 49 x 24mm



VS Series

- Dual axis measurement range from ± 5 to $\pm 45^\circ$
- High resolution and accuracy
- Low temperature drift
- RS232 output interface
- Robust corrosion resistant anodised IP67 Aluminium housing
- IP67 Sealed locking M9 connector
- Outputs isolated from supply (1500Vdc isolation)
- CE and FCC certified and RoHS compliant.



Instructions for Use

To Switch On

Press and hold the On/Off Button for at least 1 second and then release. The device will now switch on.

To Switch Off

Press and hold the On/Off Button for at least 5 seconds. After 5 seconds the device will switch off.

Display Modes

The display can be changed by pressing and releasing the Menu button. Each press and release will scroll through the display options as follows:

Single Axis (X axis) display



Dual Axis (X & Y axis) display



Single Axis (Y axis) display



Dual Axis (X & Y axis) graphical display

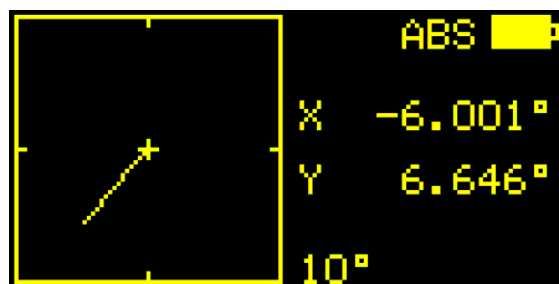

Absolute and Relative Measurement Mode

The Abs/Rel button switches the device between Absolute mode (referenced to absolute zero) and relative mode. In relative mode the device is zeroed at the position the button is pressed, and further measurements will be relative to that position. Please note that the device cannot measure (accurately) beyond the measuring range of the sensor. For example using a ±15° sensor and setting the relative mode when the device is at 5°, the measuring range will still be ±15° from horizontal, which is now -20 to +10° from the new relative zero position.

Hold Function

Pressing the Hold button will freeze the display with the measurement at the time the hold button is pressed. Press again to release the hold feature and return to normal measurement.

Battery and Power Supply

The internal Li-Ion battery should last around 30 hours in continuous use (depending on the inclinometer sensor attached) . Plugging in the power supply to the device will charge the battery and power the display and inclinometer, so it can be used when the battery is flat with the power supply attached. The external supply can also power the device if the battery is not fitted (see ordering options). From the fully discharged state it will take approximately 5 hours to charge. The display unit provides power the the inclinometer sensor.



Menu Options

To enter the settings menu, press and hold the 'Menu' button for 3 seconds. The menu screen will then appear. Pressing the menu button scrolls through the menu options. The 'Hold' button and the 'ABS/REL' button act as up/down keys to adjust the individual menu settings. All of the menu functions are stored after power down.

Brightness Adjustment

The brightness can be adjusted between a value of 1 and 10, 1 being the dimmest and 10 being the brightest. Use the 'Hold' button and the 'ABS/REL' button to decrease and increase the value respectively.

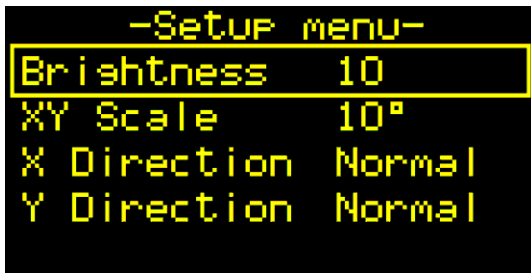

XY Scale Adjustment

This controls the scale of the graphic in graphic display mode. This is the angle required to cause the line to span the full width from the centre of the graphic to the edge. The minimum setting is 1° and the maximum is 45°.

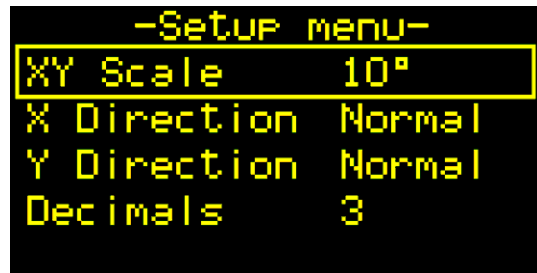

X Direction

This controls the direction of the angle output for the X axis. 'Normal' means clockwise rotation gives a positive change in angle, and 'Reverse' means a clockwise rotation gives a negative change.

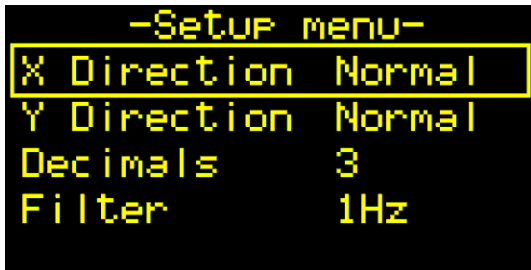

Y Direction

This controls the direction of the angle output for the Y axis. 'Normal' means clockwise rotation gives a positive change in angle, and 'Reverse' means a clockwise rotation gives a negative change.

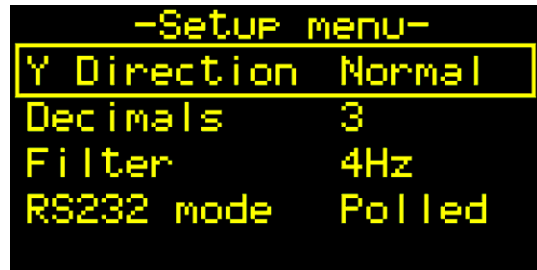

Decimals

This controls the number of decimal places to which the angle is displayed. This applies to all display modes (single axis, dual axis or graphical display mode). The minimum value is 1 and the maximum is 3.

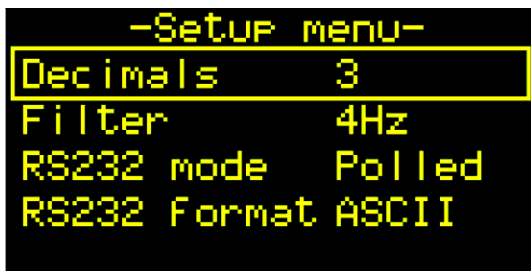

Filter

This controls the frequency response of the sensor. A high value (e.g 8Hz) will have a fast response to a change in angle, whereas a low value (0.25Hz) will have a slower response and provide more filtering with less noise.

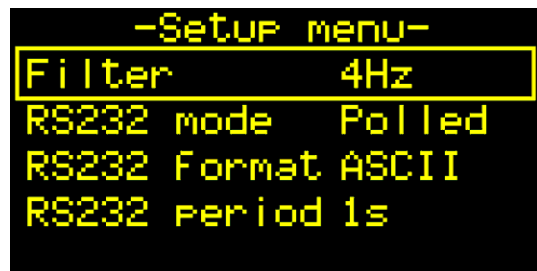



RS232 Menu Options

The display unit has a full duplex RS232 interface to enable connection to other devices. The RS232 output format can be configured from the menu options to change the BAUD rate, and select if the device transmits continuously, or in response to a command, and to set if the output format is integer hex or ASCII.

RS232 Mode

The RS232 mode can be switched between polled and continuous mode. In polled mode the device will transmit the angle in response to a request command. In continuous mode it will transmit the X and Y axis angle continuously.

```
-Setup menu-
RS232 mode Polled
RS232 Format ASCII
RS232 period 1s
Baud rate 38400
```

RS232 Format

The RS232 output format can either be in ASCII or integer mode. See page 11 for details of the data transmission protocol for ASCII and Integer mode settings.

```
-Setup menu-
RS232 Format ASCII
RS232 period 1s
Baud rate 38400
X Relay mode OFF
```

RS232 Period

In continuous output mode, this is the rate at which new data is transmitted. It is adjustable between 0.1 and 30 seconds. If the RS232 is in 'polled' mode then this setting has no effect.

```
-Setup menu-
RS232 period 1s
Baud rate 38400
X Relay mode OFF
X Relay thr 10.0°
```

RS232 BAUD Rate

This controls the RS232 transmission speed. It is adjustable between 2400bps (bits per second) and 115200bps.

```
-Setup menu-
Baud rate 38400
X Relay mode OFF
X Relay thr 10.0°
Y Relay mode OFF
```

Sensor Baud Rate

This controls the BAUD rate between the sensor and the IDS. This value needs to match the setting of the sensor. This does not affect the BAUD rate of the external RS232 interface.

```
-Setup menu-
Sensor Baud 38400
Brightness 10
XY Scale 10°
X Direction Normal
```



Tilt Switch Alarm Menu Options

The tilt switch alarm can be configured in several ways. It can be triggered from the X axis only, the Y axis only, from both the X and Y axis, or from the resultant angle of an X and Y axis tilt (called omni-directional mode). It can be set to trigger on negative value, positive values, or both negative and positive values. For the X and Y axis, it is necessary to set the operating modes. There are 5 options:

- 1. **Off** - The tilt switch will not operate on the respective axis if the setting is set to 'off'
- 2. **Negative** - The tilt switch will operate at the threshold when the threshold angle is reached in the negative tilt direction only.
- 3. **Positive** - The tilt switch will operate at the threshold when the threshold angle is reached in the positive tilt direction only.
- 4. **Negative and Positive** - The tilt switch will operate at the threshold when the threshold angle is reached in either the negative or positive tilt direction.
- 5. **Omni** - In this mode the tilt switch will operate when the angle threshold specified by the omni threshold is exceeded. Omni directional means that the resultant angle is calculated from the X and Y angles using the formula : $\text{Omni Directional Angle} = \sqrt{X^2 + Y^2}$. The omni directional angle is always a positive value.

After setting the operating mode for the X and Y axis, the X and Y axis alarm thresholds can be set.

X and Y Axis Relay Mode

There are 5 operating modes as described above. If either X or Y Axis Relay Mode is set to Omni, it will automatically set the other to Omni.

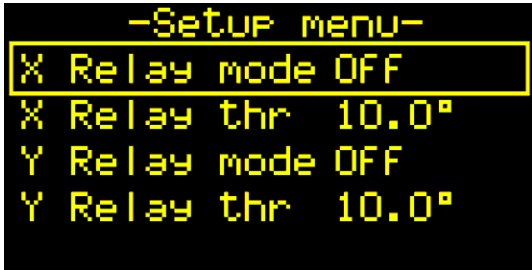

X and Y Axis Alarm Thresholds

This is the threshold angle at which the alarm will trigger. The threshold is adjustable between 0.1 and 45 degrees. The setting needs to be checked that it is compatible with the range and accuracy of the device connected to the display.

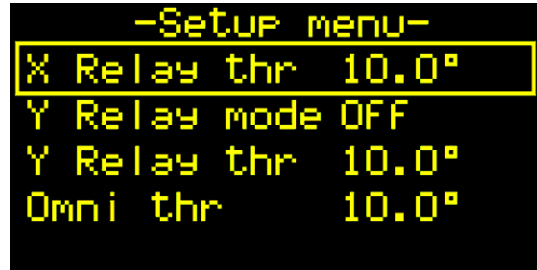

Omni Directional Alarm Threshold

This is the threshold angle at which the alarm will trigger. The threshold is adjustable between 0.1 and 45 degrees. The setting needs to be checked that it is compatible with the inclinometer connected

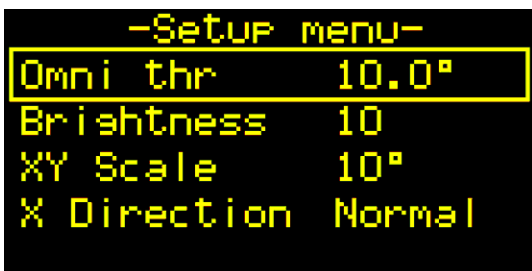



Zero Position Menu Options

Set the Zero Position at the Current Reading

Pressing the ABS button stores the current reading as the new zero position. This setting is stored in the sensor, and is saved even after a power cycle. Please note that the device cannot measure beyond the measuring range of the sensor (in relation to the absolute zero plane)

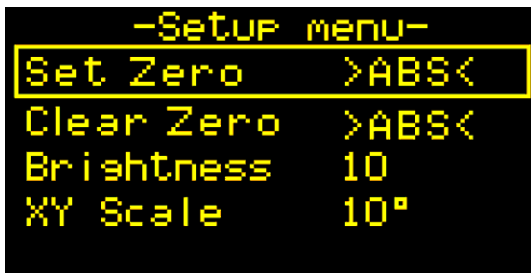

Set the Zero to Factory Defaults

Pressing the ABS button will cancel any zero offset stored in the sensor and revert back to the factory zero setting. This setting is saved even after a power cycle.

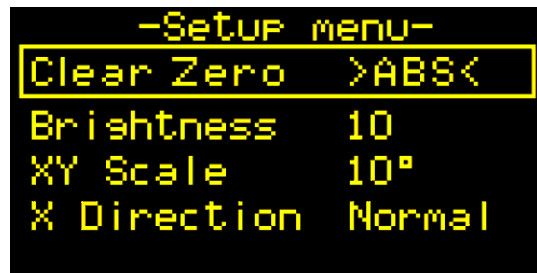

Control Command Set

Data is transmitted and received over RS232 in full duplex mode. The default configuration is with the baud rate set to 38.4kbps, with 8 data bits, 1 stop bit and no parity. All commands are lower case and 7 bytes long. The time between each character of the command must be less than 100ms otherwise the device will clear the input buffer.

Table with 4 columns: Command, Description, Response Length, Response. Rows include get--x, get--y, get-x&y, and gettemp.



Part Numbering

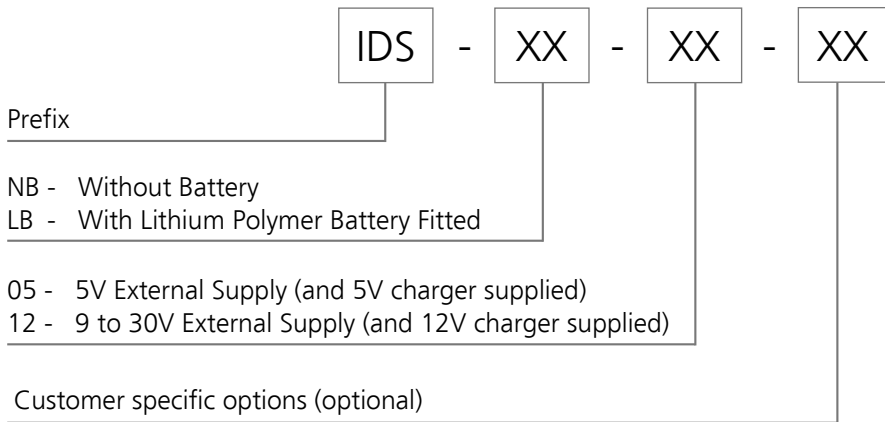

The standard configuration for the IDS is IDS-LB-12

Example:

IDS-LB-12 - Inclinometer display system :

Fitted with Lithium Polymer battery fitted, configured for 9 to 30V external dc supply and charging (and supplied with a 12V mains charger)