

WL50SWL20Q

Work Light – Spotlight

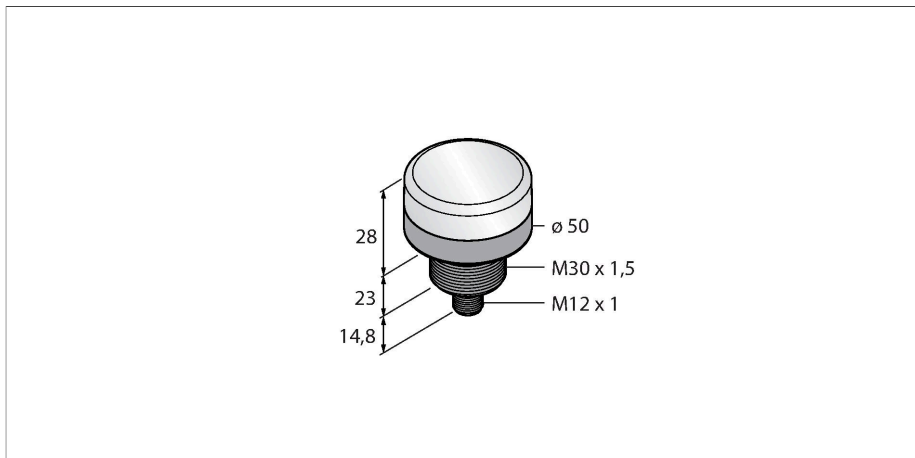

Technical data

Type	WL50SWL20Q
ID	3019042
Signal and display data	
Purpose	LED work light
Function	Spotlight
Light type	White
Color temperature	5000...+8300 K
Luminous flux lumen	0 lm
Aperture angle degree	20 °
Beam angle	20°
LED service life (L70)	50000 h
Dimmable	no
Features of color 1	White, Permanently on, 270 lm
Special features	Wash down
Electrical data	
Operating voltage	12...30 VDC
DC rated operational current	≤ 400 mA
Input power	1.7 W
Mechanical data	
Cascadable	No
Design	Puck, WL50S
Dimensions	Ø 50 x 65.8 mm
Housing material	Metal, AL, Black
Window material	Polycarbonate, clear
Electrical connection	Connector, M12 × 1, PVC
Number of cores	5

Features

- Operating voltage: 12...30 VDC
- Protection class: IP69K
- Metal housing
- Color: White
- M12 x 1 connector

Wiring diagram

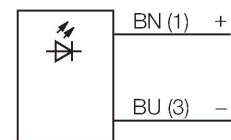

Functional principle

The energy-efficient LED work lights are ideally suited for industrial applications. The rugged IP69K protected versions can be used in many demanding applications where bright and uniform illumination is required. The electrical connection is either established via standard M12x1 connector or pigtail directly at the clamp connection of existing installations. On some models the light output is continuously dimmable via a PWM signal on pin 4.

Technical data

Ambient temperature	-20...+50 °C
Storage temperature	-40...+70 °C
Relative humidity	0...95 %
Protection class	IP67 IP69
Tests/approvals	
Approvals	CE

Accessories

Dimension drawing	Type	ID	
	RKC4.4T-2/TEL	6625013	Connection cable, female M12, straight, 4-pin, cable length: 2 m, sheath material: PVC, black; cULus approval; other cable lengths and qualities available, see www.turck.com
	WKC4.4T-2/TEL	6625025	Connection cable, female M12, angled, 4-pin, cable length: 2 m, sheath material: PVC, black; cULus approval; other cable lengths and qualities available, see www.turck.com