

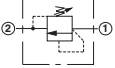

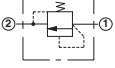

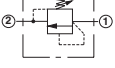

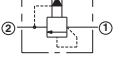
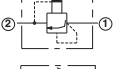

Relief Cartridge Valves

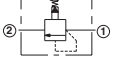
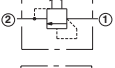
<i>Cartridge Type</i>	<i>Page</i>
 Pilot Operated, Balanced Piston	6
 Direct Acting and Direct Acting, Non-Adjustable	7
 Direct Acting, CE Marked	8
 Direct Acting, Pilot Capacity	9
 Pilot Operated, Balanced Poppet	10
 Pilot Operated, Balanced Poppet, Soft	11
 Pilot Operated, Kick-down, Balanced Piston	12
 Pilot Operated, Balanced Piston, Air Controlled	13
 Electro-Proportional, Pilot Capacity	14
 Electro-Proportional, Pilot Capacity, High Pressure Setting with No Command, Inverse Function	15
 Pilot Operated, Balanced Piston, Main Stage with Integral T-8A Control Cavity	16
 Pilot Operated, Balanced Poppet, Main Stage with Integral T-8A Control Cavity	17
 Pilot Operated, Balanced Piston, Ventable	18
 Pilot Operated, Balanced Poppet, Ventable	19
 Pilot Operated, Balanced Poppet, Ventable, Soft	20
 Bypass Compensator with Relief Function, Normally Closed	21
 Pilot Operated, Balanced Piston, Ventable with External Drain	22
 Electro-Proportional, Pilot Operated, Balanced Piston, Ventable, Drain to Port 4, Main Stage with Integral T-8A Control Cavity	23

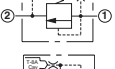
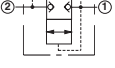

PILOT OPERATED, BALANCED PISTON

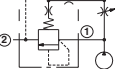
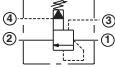
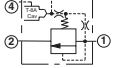
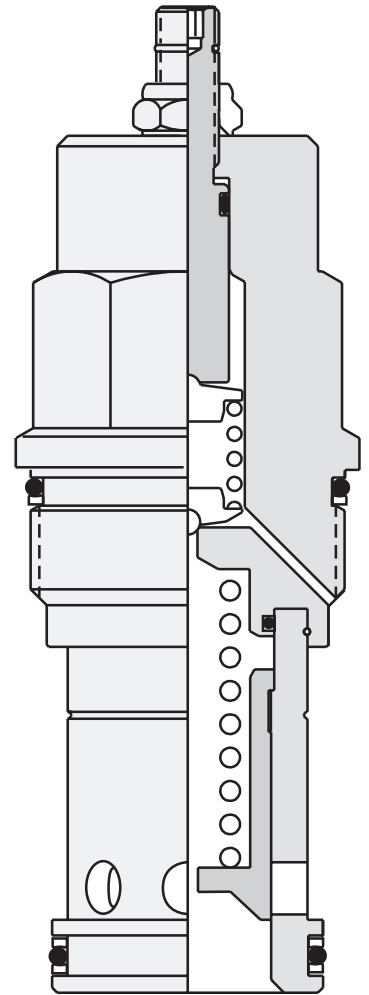
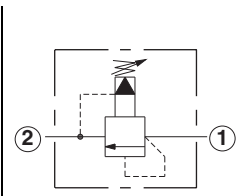
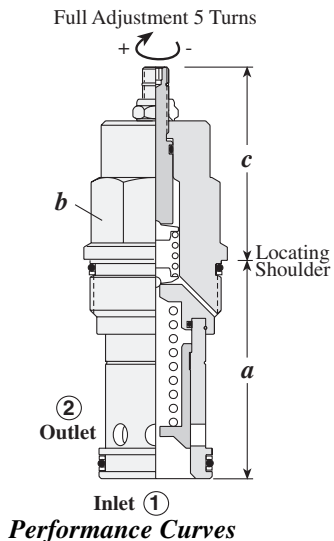

Capacity	Typical Cartridge Model Code	Cavity	Cartridge Dimensions					Installation Torque (Nm)
			a	b	c			
					L	C	K	
45 L/min.	RPCC – LAN	T - 162A	31,0	19,1	53,6	55,1	60,7	35 - 40
95 L/min.	RPEC – LAN	T - 10A	39,6	22,2	50,8	54,6	57,2	45 - 50
200 L/min.	RPGC – LAN	T - 3A	47,8	28,6	53,8	55,4	60,5	60 - 70
380 L/min.	RPIC – LAN	T - 16A	62,0	31,8	62,0	62,7	68,3	200 - 215
760 L/min.	RPKC – LAN	T - 18A	79,5	41,3	71,4	74,7	77,7	465 - 500

RPCC

RPEC

RPGC

RPIC

RPKC

Typical Pressure Rise

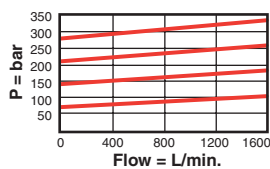
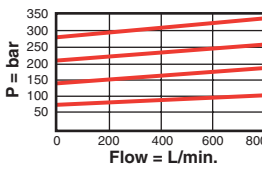
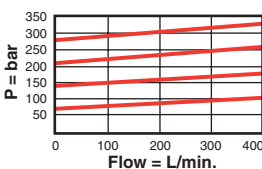
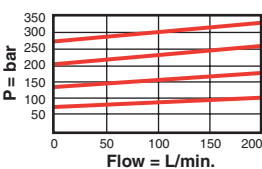
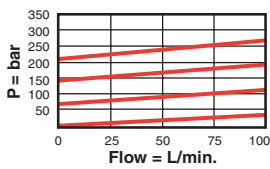

- Maximum operating pressure = 350 bar.
- Maximum valve leakage at 24 cSt = RPCC, RPEC: 30 cc/min. at 70 bar; RPGC: 50 cc/min. at 70 bar; RPIC: 65,5 cc/min. at 70 bar; RPKC: 80 cc/min. at 70 bar.
- Typical response time 10 ms.
- Factory pressure settings established at 15 L/min.
- Will accept maximum pressure at Port 2.
- Back pressure on the tank port (port 2) is directly additive at a 1:1 ratio to the valve setting.

OPTION ORDERING INFORMATION

RP * C - * * *

<p>Nominal Capacity</p> <p>C 45 L/min.</p> <p>E 95 L/min.</p> <p>G 200 L/min.</p> <p>I 380 L/min.</p> <p>K 760 L/min.</p>	<p>Control**</p> <p>L Standard Screw Adjustment</p> <p>C* Tamper Resistant Factory Set</p> <p>K Handknob with Lock Knob</p> <p>RPEC, RPGC only:</p> <p>O Handknob with Panel Mount</p> <p><i>* Special setting required. Specify at time of order.</i></p> <p><i>** See page 178 for information on Control Options</i></p> <p><i>Customer specified special setting stamped on hex.</i></p>	<p>Adjustment Range</p> <p>RPCC only:</p> <p>A 5 - 210 bar Standard set at 70 bar</p> <p>B 5 - 105 bar Standard set at 70 bar</p> <p>C 5 - 420 bar Standard set at 70 bar</p> <p>N 5 - 55 bar Standard set at 30 bar</p> <p>Q 5 - 25 bar Standard set at 14 bar</p> <p>W 5 - 315 bar Standard set at 70 bar</p> <p>RPEC, RPGC, RPIC, RPKC only:</p> <p>A 7 - 210 bar Standard set at 70 bar</p> <p>B 3,5 - 105 bar Standard set at 70 bar</p> <p>C 10,5 - 420 bar Standard set at 70 bar</p> <p>N 4 - 55 bar Standard set at 28 bar</p> <p>Q 4 - 25 bar Standard set at 14 bar</p> <p>W 10,5 - 315 bar Standard set at 70 bar</p>	<p>Seal Material</p> <p>N Buna-N</p> <p>V Viton</p> <p><i>Consult the Sun website for our most recent and complete information on the full Corrosion Resistant line of products.</i></p>
---	--	--	---

Visit www.sunhydraulics.com for current list pricing and complete technical information on all Sun products.



DIRECT ACTING AND DIRECT ACTING, NON-ADJUSTABLE

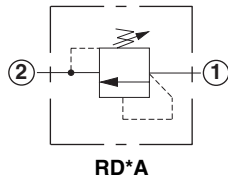
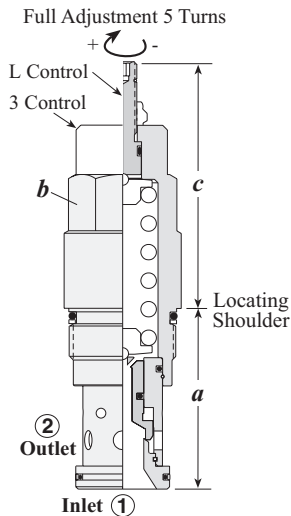

Capacity	Typical Cartridge Model Code	Cavity	Cartridge Dimensions				Installation Torque (Nm)
			a	b	L	C	
45 L/min.	RD BA – LAN	T - 162A	31,0	19,1	53,6	56,4	35 - 40
95 L/min.	RD DA – LAN	T - 10A	39,6	22,2	59,2	63,2	45 - 50
200 L/min.	RD FA – LAN	T - 3A	47,8	28,6	63,5	65,0	60 - 70
380 L/min.	RD HA – LAN	T - 16A	62,0	31,8	82,6	84,1	200 - 215
760 L/min.	RD JA – LAN	T - 18A	79,5	41,3	100,0	103,4	465 - 500

Performance Curves

RDBA

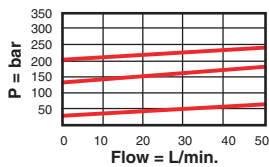

RDDA

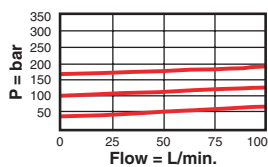

RDFA

Typical Pressure Rise

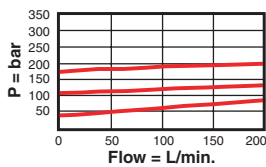

RDHA

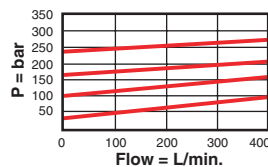

RDJA

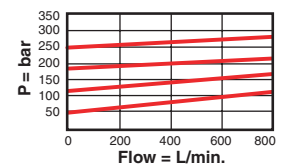

- Maximum operating pressure = 350 bar.
- Maximum valve leakage at reseal = 0,7 cc/min.
- Typical response time 2 ms.
- Factory pressure settings established at 15 L/min.
- Will accept maximum pressure at Port 2.
- Back pressure on the tank port (port 2) is directly additive at a 1:1 ratio to the valve setting.
- The seals on the adjust screw are exposed to system pressure which means this valve can only be adjusted when the pressure is removed. The setting procedure is; check the setting, remove the pressure, adjust the valve, check the new setting.
- Reseat exceeds 90% of cracking pressure.
- Select a spring range where the desired relief setting is approximately mid-range between the minimum and maximum pressure to ensure maximum valve repeatability.

OPTION ORDERING INFORMATION

RD * A - * * *

<p><i>Nominal Capacity</i></p> <p>B 45 L/min.</p> <p>D 95 L/min.</p> <p>F 200 L/min.</p> <p>H 380 L/min.</p> <p>J 760 L/min.</p>	<p><i>Control**</i></p> <p>L Standard Screw Adjustment</p> <p>C* Tamper Resistant Factory Set</p> <p>RDDA, RDFA only:</p> <p>3* Non-Adjustable</p> <p><i>* Special setting required. Specify at time of order.</i></p> <p>** See page 178 for information on Control Options</p> <p><i>Customer specified special setting stamped on hex.</i></p>	<p><i>Adjustment Range</i></p> <p>A 35 - 210 bar Standard set at 70 bar</p> <p>B 20 - 105 bar Standard set at 70 bar</p> <p>C 70 - 420 bar Standard set at 70 bar</p> <p>D 14 - 55 bar Standard set at 28 bar</p> <p>E 10 - 28 bar Standard set at 14 bar</p> <p>S 3,5 - 14 bar Standard set at 7 bar</p> <p>W 55 - 315 bar Standard set at 70 bar</p> <p><i>RD</i>DA-3, <i>RD</i>FA-3 only available with A, C, D ranges.</p>	<p><i>Seal Material</i></p> <p>N Buna-N</p> <p>V Viton</p>
---	---	---	--

U.S. Patent #4,742,846
European Patent Pending

Consult the Sun website for our most recent and complete information on the full Corrosion Resistant line of products.

Visit www.sunhydraulics.com for current list pricing and complete technical information on all Sun products.

DIRECT ACTING, CE MARKED

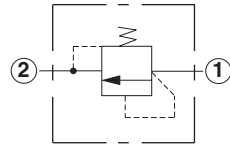
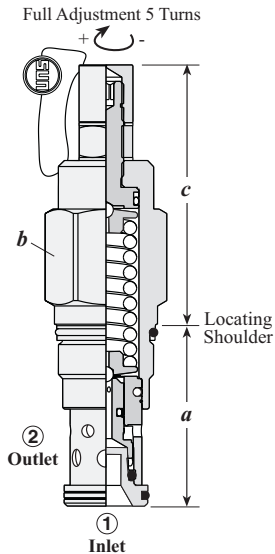

The CE marked valve is a safety valve that meets the requirements of the European Directive for Pressurized Devices (PED) 97/23/EC.

Each delivery contains a TÜV approval, which is a certification of the excess operating pressure and the approved flow, an EC declaration of conformity, and an instructional manual. See Sun website for further information.

Capacity	Typical Cartridge Model Code	Cavity	Cartridge Dimensions			Installation Torque (Nm)
			a	b	c	
75 L/min.	RDDT - QAN	T - 10A	40,0 mm	22,2 mm	65,0 mm	45 - 50
79 L/min.	RDFT - QAN	T - 3A	47,8 mm	28,6 mm	70,4 mm	60 - 70

Performance Curves

RDDT

RDFT

Permissible Operating Range

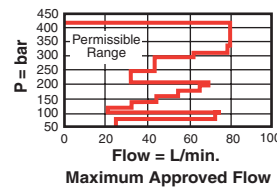
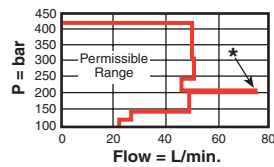

*Approved flow at 210 bar is 75 L/min.

- Maximum valve leakage at reseal = 0,7 cc/min.
- Reseat = > 90% of set pressure.
- Typical response time 2 ms.
- Standard settings for preset valves: 100, 140, 160, 210, 250, and 330 bar.
- Pressure setting from 100 bar up to 422 bar are approved and certified by TÜV.
- Will accept maximum pressure at port 2; suitable for use in cross-port relief circuits.
- Back pressure on the tank port (port 2) is additive to the valve setting at a 1:1 ratio.

OPTION ORDERING INFORMATION

RD * T - * * *		Seal Material	
Nominal Capacity	Control	Adjustment Range	
D 75 L/min.	Q* Capped and Lockwire	RDDT: A 100 - 210 bar	N Buna-N
F 79 L/min.	* Special setting required. Specify at time of order.	C 315 - 422 bar W 211 - 314 bar	V Viton
		RDFT: A 106 - 209 bar B 60 - 105 bar C 210 - 420 bar	

U.S. Patent #4,742,846

Visit www.sunhydraulics.com for current list pricing and complete technical information on all Sun products.

DIRECT ACTING, PILOT CAPACITY

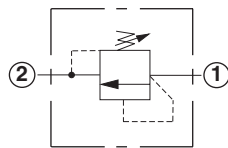
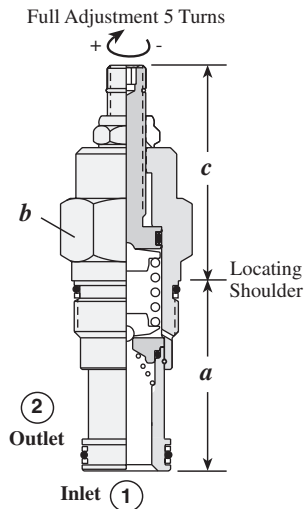

Capacity	Typical Cartridge Model Code	Cavity	Cartridge Dimensions						Installation Torque (Nm)
			a	b	c				
					L	C	K	O	
1 L/min.	RBAC – LAN	T - 10A	39,6	22,2	50,8	54,6	57,2	58,0	45 - 50
2 L/min.	RBAA – LAN	T - 3A	47,8	28,6	53,8	55,4	60,5	61,0	60 - 70
10 L/min.	RBAE – LAN	T - 8A	19,0	22,2	60,5	62,7	67,6	67,6	35 - 40

Performance Curves

RBAC

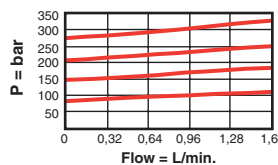

RBAA

Typical Pressure Rise

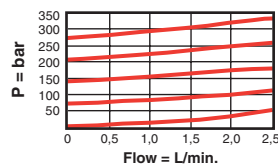

RBAE

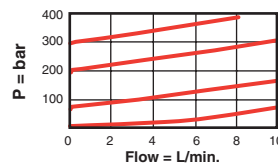

- Maximum operating pressure = 350 bar.
- Maximum valve leakage at reseal at 24 cSt = RBAC, RBAA: 0,4 cc/min.; RBAE: 1 cc/min.
- Typical response time 2 ms.
- Back pressure on the tank port (port 2) is directly additive to the pressure setting at port 1 (inlet) at a 1:1 ratio to the valve setting.
- RBAE: Utilizes the Sun T-8A, 2 port cavity making it the ideal choice to use in conjunction with Sun's main stage pilot or vent-to-operate cartridges. Separate pilot lines are eliminated and only one cavity needs to be machined to accommodate both the control and primary function. Note: All 2-position, 2-way pilot stage control cartridges utilize the same cavity and are physically interchangeable. Functionality is the only consideration.

OPTION ORDERING INFORMATION

RB A * - * * *

Nominal Capacity	Control**	Adjustment Range	Seal Material
AC 1 L/min.	L Standard Screw Adjustment	A 1,7 - 210 bar Standard set at 70 bar	N Buna-N
AA 2 L/min.	C* Tamper Resistant with Lock Knob	B 1,7 - 105 bar Standard set at 70 bar	V Viton
AE 10 L/min.	K Handknob Factory Set	C 1,7 - 420 bar Standard set at 70 bar	
	O Handknob with Panel Mount	D 1,7 - 55 bar Standard set at 25 bar	
	* Special setting required. Specify at time of order.	E 1,7 - 25 bar Standard set at 14 bar	
	** See page 178 for information on Control Options	W 1,7 - 315 bar Standard set at 70 bar	
	Customer specified special setting stamped on hex.		

Consult the Sun website for our most recent and complete information on the full Corrosion Resistant line of products.

Visit www.sunhydraulics.com for current list pricing and complete technical information on all Sun products.

PILOT OPERATED, BALANCED POPPET

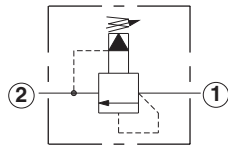
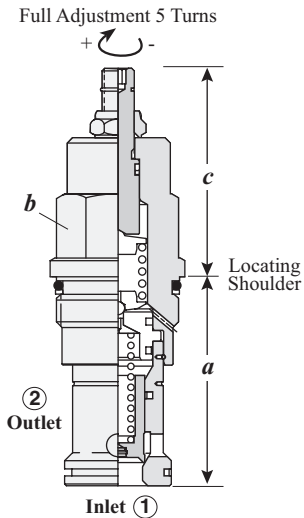

Capacity	Typical Cartridge Model Code	Cavity	Cartridge Dimensions			Installation Torque (Nm)
			a	b	c	
95 L/min.	RPES – LAN	T - 10A	39,6	22,2	L: 50,8 C: 54,6 K: 57,2	40 - 50
200 L/min.	RPGS – LAN	T - 3A	47,8	28,6	L: 53,8 C: 55,4 K: 60,5	60 - 70
380 L/min.	RPIS – LAN	T - 16A	62,0	31,8	L: 62,0 C: 62,7 K: 68,3	200 - 215
760 L/min.	RPKS – LAN	T - 18A	79,5	41,3	L: 71,4 C: 74,7 K: 77,7	465 - 500

Performance Curves

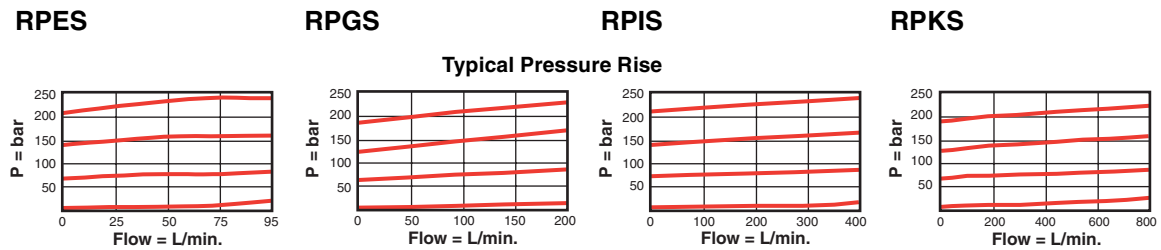

- Maximum operating pressure = 350 bar.
- Maximum valve leakage at reseal = RPES: 0,7 cc/min.; RPGS, RPIS, RPKS: 2,1 cc/min.
- Typical response time 2 ms.
- Factory pressure settings established at 15 L/min.
- Will accept maximum pressure at port 2; suitable for use in cross-port relief circuits.
- Back pressure on the tank port (port 2) is directly additive at a 1:1 ratio to the valve setting.

OPTION ORDERING INFORMATION

RP * S - * * *			
Nominal Capacity	Control**	Adjustment Range	Seal Material
E 95 L/min.	C* Tamper Resistant Factory Set	A 7 - 210 bar Standard set at 70 bar	N Buna-N
G 200 L/min.	K Handknob with Lock Knob	B 3,5 - 105 bar Standard set at 70 bar	V Viton
I 380 L/min.	L Standard Screw Adjustment	C 10,5 - 420 bar Standard set at 70 bar	
K 760 L/min.		N 4 - 55 bar Standard set at 30 bar	
		Q 4 - 25 bar Standard set at 14 bar	
		RPES, RPGS only: W 7 - 315 bar Standard set at 70 bar	
		RPIS, RPKS only: W 10,5 - 315 bar Standard set at 70 bar	

* *Special setting required. Specify at time of order.*

** *See page 178 for information on Control Options*

Customer specified special setting stamped on hex.

Consult the Sun website for our most recent and complete information on the full Corrosion Resistant line of products.

Visit www.sunhydraulics.com for current list pricing and complete technical information on all Sun products.

PILOT OPERATED, BALANCED POPPET, SOFT

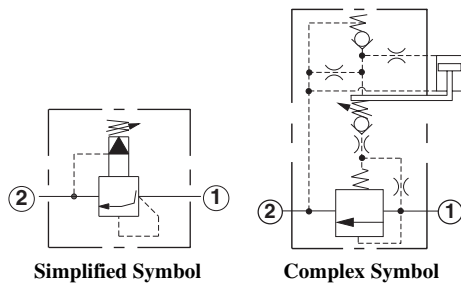
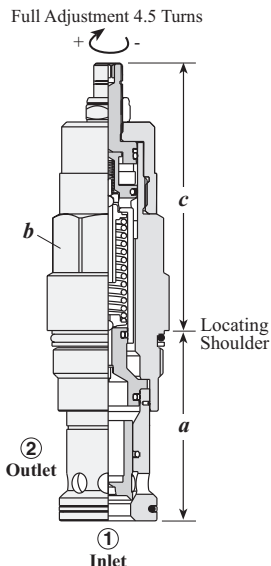

Capacity	Typical Cartridge Model Code	Cavity	Cartridge Dimensions				Installation Torque (Nm)
			a	b	L	C	
95 L/min.	RPET - LAN	T - 10A	39,6	22,8	79,5	85,1	40 - 50
200 L/min.	RPGT - LAN	T - 3A	47,8	28,6	85,9	88,1	60 - 70
380 L/min.	RPIT - LAN	T - 16A	61,7	31,8	86,9	89,2	200 - 215
760 L/min.	RPKT - LAN	T - 18A	79,2	41,3	88,4	85,3	465 - 500

Performance Curves

RPET

RPGT

RPIT

RPKT

Pressure Differential vs. Flow

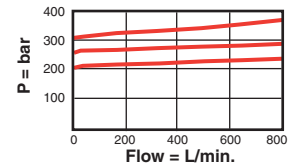
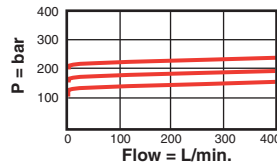
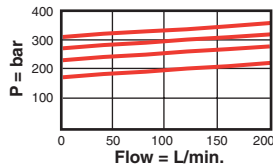
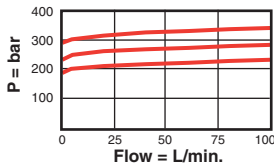

Time vs. Pressure

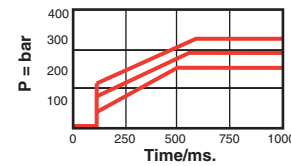
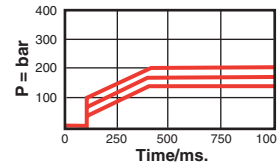
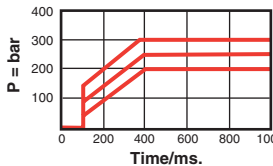
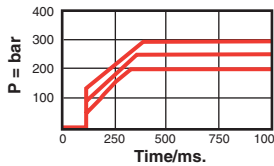

- Maximum operating pressure = 350 bar.
- Control pilot flow = 0,16 to 0,41 L/min.
- Pressure Ramp Up Time = RPET: 200 ms., RPGT: 300 ms., RPIT: 400 ms., RPKT: 500 ms.
- Factory pressure settings established at 15 L/min.
- Will accept maximum pressure at Port 2.
- When pressure at the inlet (port 1) exceeds the threshold setting, the valve opens to tank (port 2). The pilot section moves forward at a steady rate, increasing the setting by compressing the pilot spring. Maximum setting is achieved when the pilot section reaches a mechanical stop.

OPTION ORDERING INFORMATION

RP * T - * * *

<p>Nominal Capacity</p> <p>E 95 L/min.</p> <p>G 200 L/min.</p> <p>I 380 L/min.</p> <p>K 760 L/min.</p>	<p>Control**</p> <p>C* Tamper Resistant Factory Set</p> <p>L Standard Screw Adjustment</p> <p><i>* Special setting required. Specify at time of order.</i></p> <p><i>** See page 178 for information on Control Options</i></p>	<p>Adjustment Range</p> <p>A 140 - 210 bar Standard set at 140 bar</p> <p>C 315 - 420 bar Standard set at 315 bar</p> <p>W 210-315 bar Standard set at 210 bar</p>	<p>Seal Material</p> <p>N Buna-N</p> <p>V Viton</p>
---	--	--	--

Patent: U.S. #6,039,070. Customer specified special setting stamped on hex.

Visit www.sunhydraulics.com for current list pricing and complete technical information on all Sun products.

PILOT OPERATED, KICK-DOWN, BALANCED PISTON

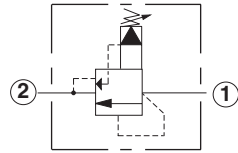
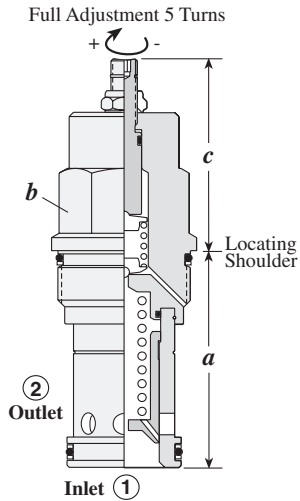

Capacity	Typical Cartridge Model Code	Cavity	Cartridge Dimensions					Installation Torque (Nm)
			a	b	c			
					L	C	K	
45 L/min.	RQCB - LAN	T - 162A	31,0	19,1	53,6	55,1	58,7	35 - 40
95 L/min.	RQEB - LAN	T - 10A	39,6	22,2	50,8	54,6	57,2	45 - 50
200 L/min.	RQGB - LAN	T - 3A	47,8	28,6	53,8	55,4	60,5	60 - 70
380 L/min.	RQIB - LAN	T - 16A	62,0	31,8	62,0	62,7	68,3	200 - 215
760 L/min.	RQKB - LAN	T - 18A	79,5	41,3	71,4	74,7	77,7	465 - 500

Performance Curves

RQCB

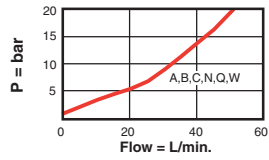

RQEB

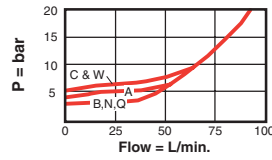

RQGB

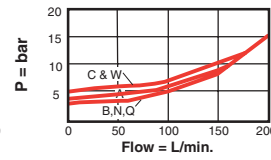

RQIB

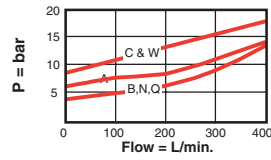

RQKB

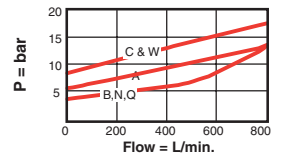

Unloaded Pressure Drop

- Maximum operating pressure = 350 bar.
- Maximum valve leakage at 24 cSt = RQCB, RQEB: 30 cc/min. at 70 bar; RQGB: 49,2 cc/min. at 70 bar; RQIB: 65,5 cc/min. at 70 bar; RQKB: 81,9 cc/min. at 70 bar.
- Typical response time 25 ms.
- Factory pressure settings established at kick down point.
- Flow through cartridge must cease to reset valve.
- Back pressure on the tank port (port 2) is directly additive to the valve setting at a 1:1 ratio.

OPTION ORDERING INFORMATION

RQ * B - * * *

Nominal Capacity	Control**	Adjustment Range	Seal Material
C 45 L/min.	L Standard Screw Adjustment	RQCB only: A 5 - 210 bar Standard set at 70 bar	N Buna-N
E 95 L/min.	C* Tamper Resistant Factory Set	B 5 - 105 bar Standard set at 70 bar	V Viton
G 200 L/min.	K Handknob with Lock Knob	C 5 - 420 bar Standard set at 70 bar	
I 380 L/min.		N 5 - 55 bar Standard set at 25 bar	
K 760 L/min.		Q 5 - 25 bar Standard set at 14 bar	
		W 5 - 315 bar Standard set at 70 bar	
		RQEB, RQGB, RQIB, RQKB only:	
		A 7 - 210 bar Standard set at 70 bar	
		B 3,5 - 105 bar Standard set at 70 bar	
		C 10,5 - 420 bar Standard set at 70 bar	
		Q 4 - 25 bar Standard set at 14 bar	
		W 10,5 - 315 bar Standard set at 70 bar	
		RQEB, RQGB, only:	
		N 4 - 55 bar Standard set at 25 bar	

* Special setting required. Specify at time of order.

** See page 178 for information on Control Options

Customer specified special setting stamped on hex.

Consult the Sun website for our most recent and complete information on the full Corrosion Resistant line of products.

Visit www.sunhydraulics.com for current list pricing and complete technical information on all Sun products.

PILOT OPERATED, BALANCED PISTON, AIR CONTROLLED

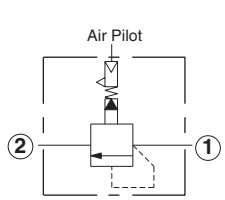
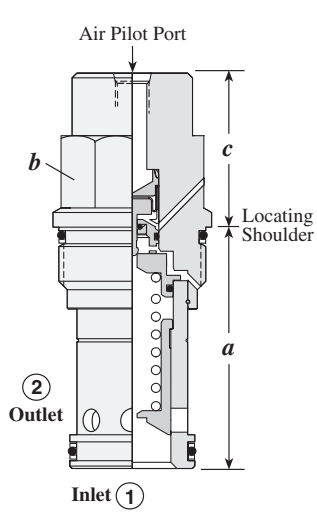

Capacity	Typical Cartridge Model Code	Cavity	Cartridge Dimensions				Installation Torque (Nm)
			a	b	c		
200 L/min.	RPGD – ABN	T - 3A	47,8	28,6	33,3	—	60 - 70
380 L/min.	RPID – BBN	T - 16A	62,0	31,8	—	41,1	200 - 215
760 L/min.	RPKD – BBN	T - 18A	79,5	41,3	—	50,8	465 - 500

Performance Curves

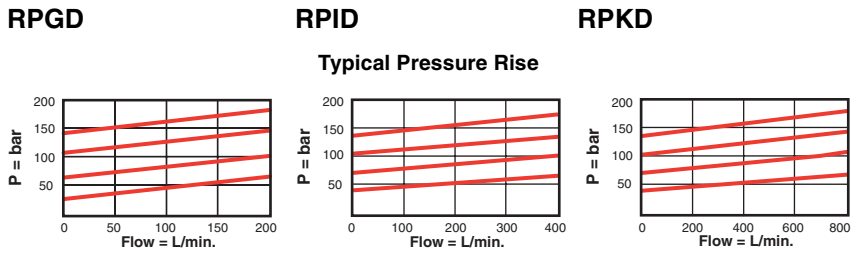

- Pilot ratio, air to hydraulic = 20:1.
- Maximum air pressure = 10,5 bar.
- Maximum operating pressure = 140 bar.
- Maximum valve leakage at 24 cSt = RPGD: 50 cc/min. at 70 bar; RPID: 65 cc/min. at 70 bar; RPKD: 80 cc/min. at 70 bar.
- Typical response time 10 ms.
- Will accept maximum pressure at Port 2; suitable for use in cross-port relief circuits.

OPTION ORDERING INFORMATION

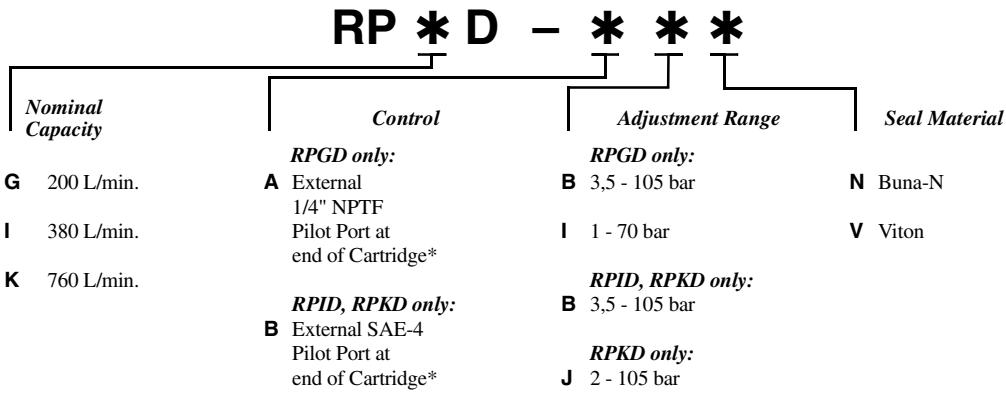

* Maximum air pilot pressure should not exceed 10 bar.

Visit www.sunhydraulics.com for current list pricing and complete technical information on all Sun products.



ELECTRO-PROPORTIONAL, PILOT CAPACITY

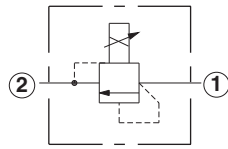
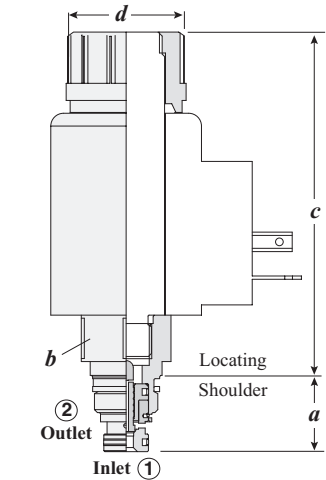

Capacity	Typical Cartridge Model Code	Cavity	Cartridge Dimensions				Installation Torque (Nm)	
			a	b	c***			d
					L/T	X/M		
1 L/min.	RBAP - X**	T - 8A	18,8	22,2	130,0	85,1	37,3	35 - 40

***An additional 50,8 mm clearance is needed for coil installation and removal.

Performance Curves

RBAP

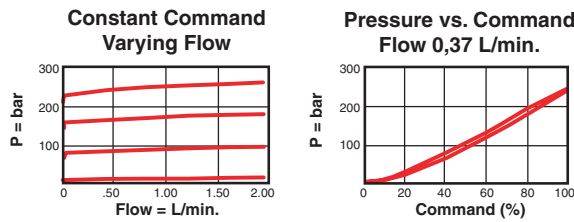

- Maximum operating pressure = 350 bar.
- Maximum valve leakage at reseal = 25 cc/min.
- Hysteresis with dither <4% and with DC input <8%.
- Linearity with dither <2% and repeatability with dither <2%.
- Recommended dither frequency = 140 Hz.
- Low leakage at levels in the closed position. Reseat occurs at 85% of cracking pressure.
- For optimum performance, an amplifier with current sensing and adjustable dither should be used. Dither should be adjustable between 100 - 250 Hz.
- The L control allows one to manually adjust the valve in case of an electrical failure. The L control also allows one to offset the pressure range. For instance, if an A range valve is mechanically offset to a setting of 105 bar, the new maximum will be 310 bar.
- This electro-proportional cartridge utilizes the Sun T-8A, 2 port cavity making it the ideal choice to use in conjunction with Sun's main stage pilot or vent-to-operate cartridges. Separate pilot lines are eliminated and only one cavity needs to be machined to accommodate both the control and primary function. Note: All 2 port pilot stage control cartridges utilize the same cavity and are physically interchangeable. Functionality is the only consideration.
- A wide variety of coil termination and voltage options are available. See the Sun website: Products: Accessories: Coils.

OPTION ORDERING INFORMATION

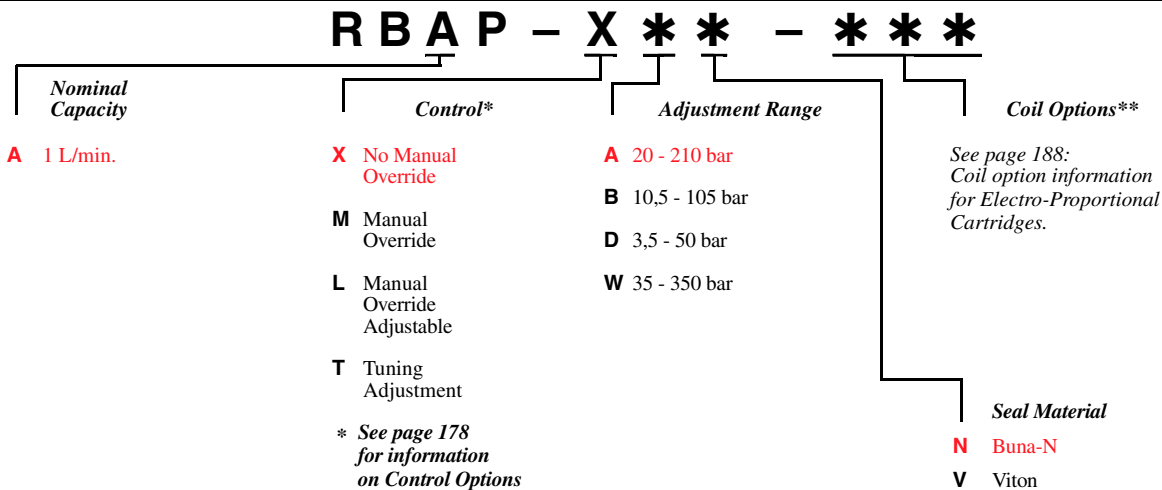

** Consult the Sun website for complete information on Spool Configurations, the full line of Coil Options and Embedded Amplifier Coils/Controllers.

Visit www.sunhydraulics.com for current list pricing and complete technical information on all Sun products.

ELECTRO-PROPORTIONAL, PILOT CAPACITY, HIGH PRESSURE SETTING WITH NO COMMAND, INVERSE FUNCTION

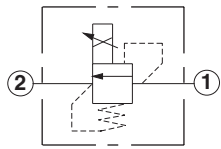
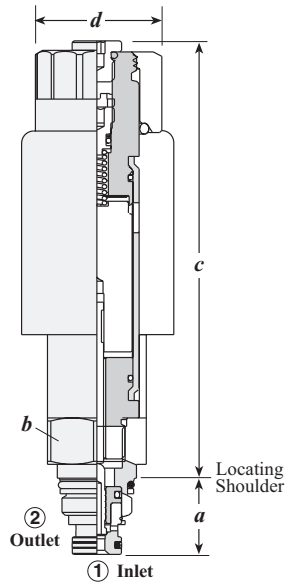

Capacity	Typical Cartridge Model Code	Cavity	Cartridge Dimensions				Installation Torque (Nm)
			a	b	c***	d	
1 L/min.	RBAN - XAN	T - 8A	18,8	22,2	108,2	37,3	35 - 40

*** An additional 50,8 mm clearance is needed for coil installation and removal.

Performance Curves

RBAN

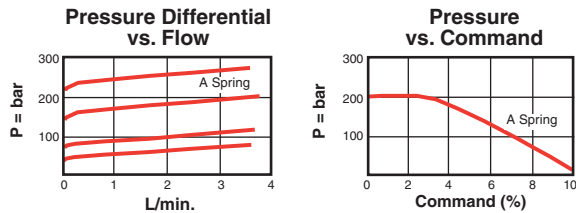

- Maximum operating pressure = 350 bar.
- Maximum valve leakage at reseal = 25 cc/min.
- Hysteresis with dither <4% and with DC input <8%.
- Linearity with dither <2% and repeatability with dither <2%.
- Recommended dither frequency = 140 Hz.
- Low leakage at levels in the closed position. Reseat occurs at 85% of cracking pressure.
- For optimum performance, an amplifier with current sensing and adjustable dither should be used. Dither should be adjustable between 100 - 250 Hz.
- This electro-proportional cartridge utilizes the Sun T-8A, 2 port cavity making it the ideal choice to use in conjunction with Sun's main stage pilot or vent-to-operate cartridges. Separate pilot lines are eliminated and only one cavity needs to be machined to accommodate both the control and primary function. Note: All 2 port pilot stage control cartridges utilize the same cavity and are physically interchangeable. Functionality is the only consideration.
- Desired de-energized pressure, within the adjustment range must be specified when ordered.
- A wide variety of coil termination and voltage options are available. See the Sun website: Products: Accessories: Coils.

OPTION ORDERING INFORMATION

R B A N - X * * - * * *

Nominal Capacity	Control	Adjustment Range*	Seal Material	Coil Options**
A 1 L/min.	X* No Manual Override * Special setting required. Specify at time of order. Customer specified special setting stamped on hex.	A 210 - 105 bar B 105 - 55 bar D 55 - 20 bar W 315- 210 bar * Customer is required to specify setting within the selected spring range.	N Buna-N V Viton	See page 188: Coil option information for Electro-Proportional Cartridges.

Visit www.sunhydraulics.com for current list pricing and complete technical information on all Sun products.

PILOT OPERATED, BALANCED PISTON, MAIN STAGE WITH INTEGRAL T-8A CONTROL CAVITY

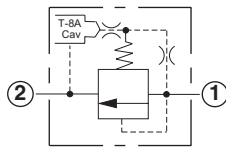
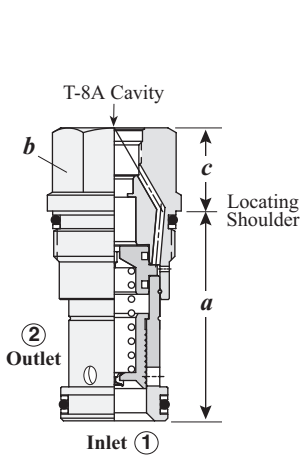

The -8 control option allows a pilot control valve to be incorporated directly into the end of the relief cartridge via the T-8A cavity. These pilot control cartridges are sold separately and include electro-proportional, solenoid, air pilot, and hydraulic pilot operation. See Pilot Control Cartridges on page 141.

Capacity	Typical Cartridge Model Code	Cavity	Cartridge Dimensions			Installation Torque (Nm)
			a	b	c	
95 L/min.	RPEC - 8WN	T - 10A	39,6	22,2	19,0	45 - 50
200 L/min.	RPGC - 8WN	T - 3A	47,8	28,6	17,5	60 - 70
380 L/min.	RPIC - 8WN	T - 16A	62,0	31,8	24,6	200 - 215
760 L/min.	RPKC - 8WN	T - 18A	79,5	41,3	30,2	465 - 500

Performance Curves

RPEC-8

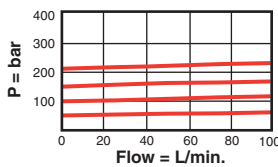

RPGC-8

Pressure vs. Flow with T-8A Pilot Stage Installed

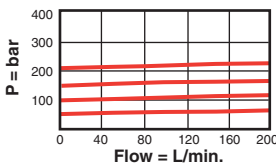

RPIC-8

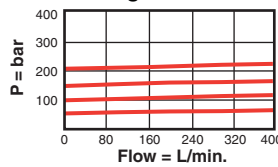

RPKC-8

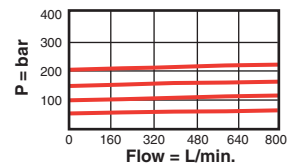

Pressure vs. Command with T-8A Pilot Stage (RBAP-MAN) Installed

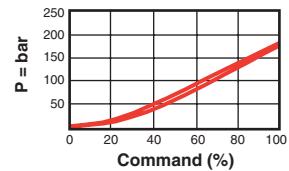
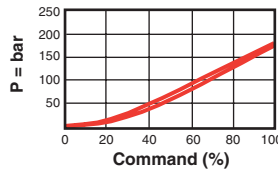
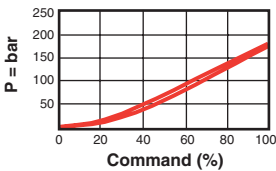
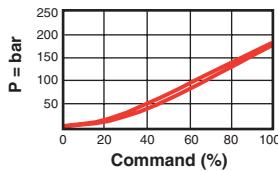

- Maximum operating pressure = 350 bar.
- Control pilot flow = RPEC-8: 0,11 to 0,16 L/min.; RPGC-8: 0,16 to 0,25 L/min.; RPIC-8, RPKC-8: 0,25 to 0,33 L/min.
- Main stage leakage at 24 cSt = RPEC-8: 50 cc/min. at 70 bar; RPGC-8: 50 cc/min. at 70 bar; RPIC-8: 65 cc/min. at 70 bar; RPKC-8: 80 cc/min. at 70 bar.
- Will accept maximum pressure at Port 2; suitable for use in cross-port relief circuits.
- Back pressure on the tank port (port 2) is directly additive to the valve setting at a 1:1 ratio.
- With the -8 control option, the main stage valve should first be installed to the correct torque value. The T-8A pilot control valve should then be installed into the main stage valve to its required torque value.

OPTION ORDERING INFORMATION

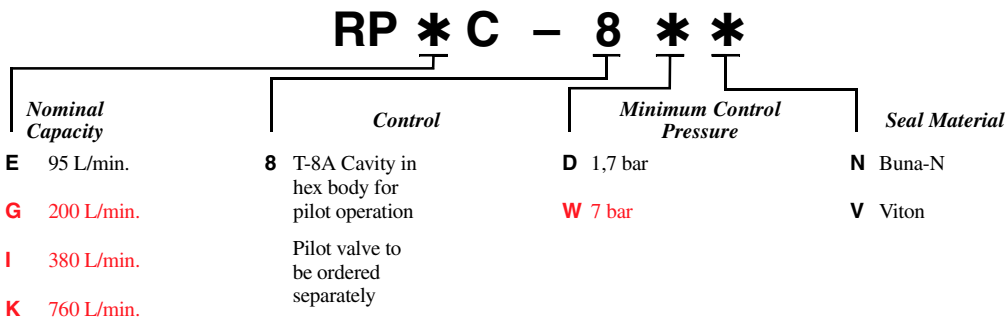

Visit www.sunhydraulics.com for current list pricing and complete technical information on all Sun products.

PILOT OPERATED, BALANCED POPPET, MAIN STAGE WITH INTEGRAL T-8A CONTROL CAVITY

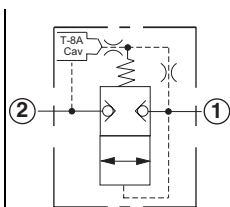
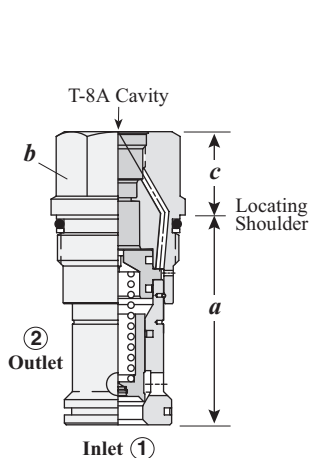

The -8 control option allows a pilot control valve to be incorporated directly into the end of the relief cartridge via the T-8A cavity. These pilot control cartridges are sold separately and include electro-proportional, solenoid, air pilot, and hydraulic pilot operation. See Pilot Control Cartridges on page 141.

Capacity	Typical Cartridge Model Code	Cavity	Cartridge Dimensions			Installation Torque (Nm)
			a	b	c	
95 L/min.	RPES - 8WN	T - 10A	39,6	22,2	19,0	40 - 50
200 L/min.	RPGS - 8WN	T - 3A	47,8	28,6	17,5	60 - 70
380 L/min.	RPIS - 8WN	T - 16A	62,0	31,8	24,6	200 - 215
760 L/min.	RPKS - 8WN	T - 18A	79,2	41,3	30,0	465 - 500

Performance Curves

RPES-8

RPGS-8

RPIS-8

RPKS-8

Pressure Differential vs. Flow with T-8A Pilot Stage Installed

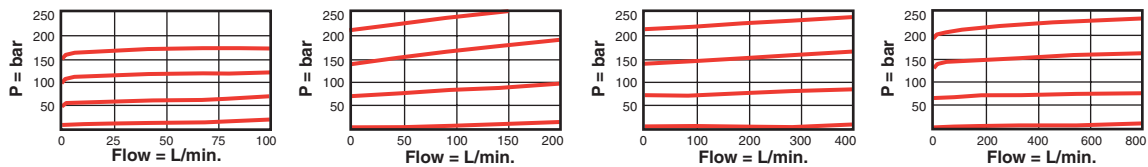

Pressure vs. Command with T-8A Pilot Stage (RBAP-MAN) Installed

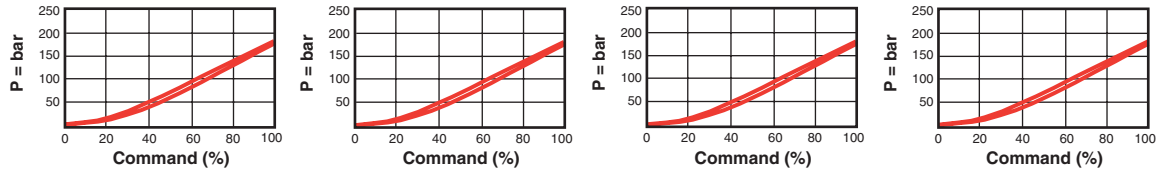

- Maximum operating pressure = 350 bar.
- Control pilot flow = RPES-8: 0,16 to 0,41 L/min.; RPGS-8: 0,16 to 0,25 L/min.; RPIS-8, RPKS-8: 0,25 to 0,33 L/min.
- Main stage leakage at 10% reseal = 0,7 cc/min.
- Typical response time 2 ms.
- Will accept maximum pressure at Port 2; suitable for use in cross-port relief circuits.
- Back pressure on the tank port (port 2) is directly additive to the valve setting at a 1:1 ratio.
- With the -8 control option, the main stage valve should first be installed to the correct torque value. The T-8A pilot control valve should then be installed into the main stage valve to its required torque value.

OPTION ORDERING INFORMATION

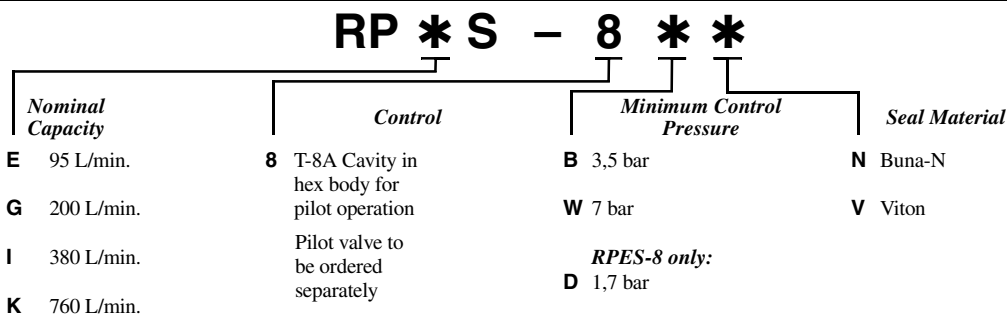

Visit www.sunhydraulics.com for current list pricing and complete technical information on all Sun products.

PILOT OPERATED, BALANCED PISTON, VENTABLE

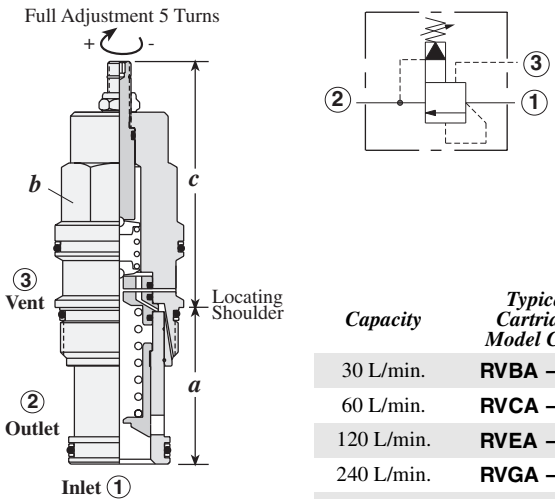

Capacity	Typical Cartridge Model Code	Cavity	Cartridge Dimensions						Installation Torque (Nm)
			a	b	c				
30 L/min.	RVBA – LAN	T - 163A	31,0	19,1	L	C	K	O	35 - 40
60 L/min.	RVCA – LAN	T - 11A	35,1	22,2	63,5	67,3	70,0	70,0	45 - 50
120 L/min.	RVEA – LAN	T - 2A	34,8	28,6	71,4	73,2	77,7	—	60 - 70
240 L/min.	RVGA – LAN	T - 17A	46,0	31,8	83,3	84,1	89,7	—	200 - 215
480 L/min.	RVIA – LAN	T - 19A	63,5	41,3	100,0	103,9	106,4	—	465 - 500

Performance Curves

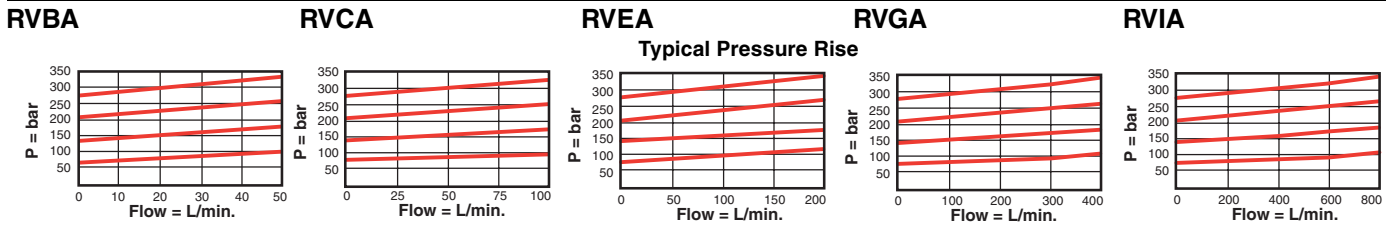

- Maximum operating pressure = 350 bar.
- Maximum valve leakage at 24 cSt = RVBA, RVCA: 30 cc/min. at 70 bar; RVEA: 50 cc/min. at 70 bar; RVGA: 65 cc/min. at 70 bar; RVIA: 80 cc/min. at 70 bar.
- Typical response time 10 ms.
- Control pilot flow = RVBA, RVCA: 0,11 to 0,16 L/min.; RVEA: 0,16 to 0,25 L/min.; RVGA, RVIA: 0,25 to 0,33 L/min.
- Factory pressure setting established at 15 L/min.
- A remote pilot relief on port 3 (vent) will control the valve below its own setting.
- Will accept maximum pressure at port 2; suitable for use in cross-port relief circuits. If used in cross-port relief circuits, consider spool leakage.
- Back pressure on the tank port (port 2) is directly additive to the valve setting at a 1:1 ratio.

OPTION ORDERING INFORMATION

RV * A - * * *

<p>Nominal Capacity</p> <p>B 30 L/min.</p> <p>C 60 L/min.</p> <p>E 120 L/min.</p> <p>G 240 L/min.</p> <p>I 480 L/min.</p>	<p>Control**</p> <p>L Standard Screw Adjustment</p> <p>C* Tamper Resistant Factory Set</p> <p>K Handknob with Lock Knob</p> <p>RVCA, RVEA only:</p> <p>O Handknob with Panel Mount</p> <p><i>*Special setting required. Specify at time of order.</i></p> <p>** See page 178 for information on Control Options</p> <p><i>Customer specified special setting stamped on hex.</i></p>	<p>Adjustment Range</p> <p>RVBA only:</p> <p>A 5 - 210 bar Standard set at 70 bar</p> <p>B 5 - 105 bar Standard set at 70 bar</p> <p>C 5 - 420 bar Standard set at 70 bar</p> <p>N 5 - 55 bar Standard set at 28 bar</p> <p>Q 5 - 25 bar Standard set at 14 bar</p> <p>W 5 - 315 bar Standard set at 70 bar</p> <p>RVCA, RVEA, RVGA, RVIA only:</p> <p>A 7 - 210 bar Standard set at 70 bar</p> <p>B 3,5 - 105 bar Standard set at 70 bar</p> <p>C 10 - 420 bar Standard set at 70 bar</p> <p>D 1,7 - 55 bar Standard set at 28 bar</p> <p>E 1,7 - 28 bar Standard set at 14 bar</p> <p>W 10 - 315 bar Standard set at 70 bar</p>	<p>Seal Material</p> <p>N Buna-N</p> <p>V Viton</p> <p><i>Consult the Sun website for our most recent and complete information on the full Corrosion Resistant line of products.</i></p> <p>Adjustment Ranges (Continued)</p> <p>RVEA, RVIA only:</p> <p>N 4 - 55 bar Standard set at 28 bar</p> <p>RVEA only:</p> <p>Q 4 - 28 bar Standard set at 14 bar</p>
---	---	--	---

Visit www.sunhydraulics.com for current list pricing and complete technical information on all Sun products.



PILOT OPERATED, BALANCED POPPET, VENTABLE

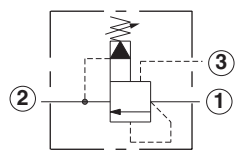
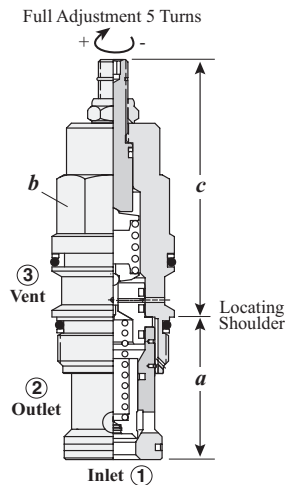

Capacity	Typical Cartridge Model Code	Cavity	Cartridge Dimensions					Installation Torque (Nm)
			a	b	c			
					L	C	K	
60 L/min.	RVCS – LAN	T - 11A	34,8	22,2	63,2	67,3	70,0	45 - 50
95 L/min.	RVES – LAN	T - 2A	34,8	28,6	71,4	73,2	77,7	60 - 70
200 L/min.	RVGS – LAN	T - 17A	46,0	31,8	83,3	84,1	89,7	200 - 215
480 L/min.	RVIS – LAN	T - 19A	63,5	41,3	99,8	103,1	106,4	465 - 500

Performance Curves

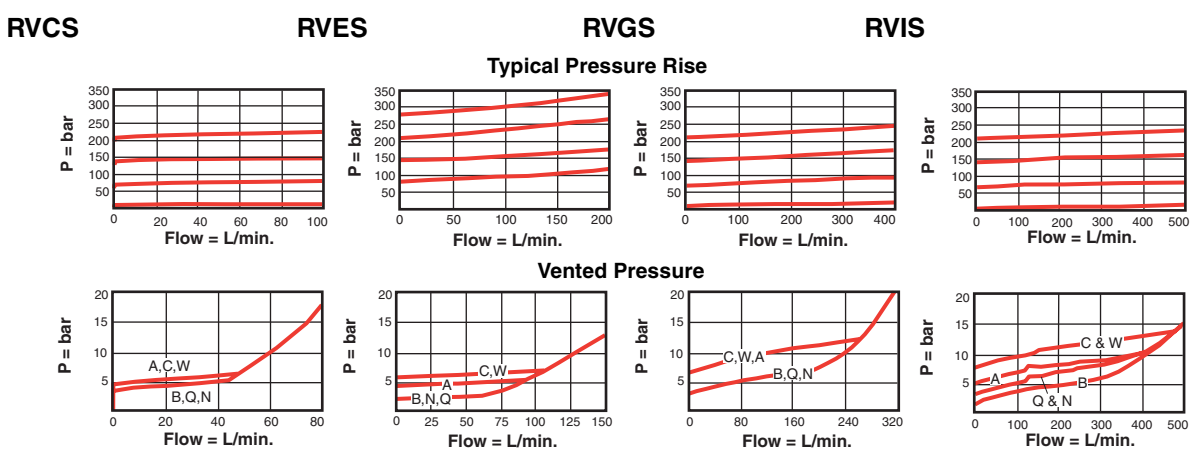

- Maximum operating pressure = 350 bar.
- Maximum valve leakage at 90% reseal = RVCS: 2 cc/min at 70 bar.; RVES, RVGS, RVIS: 0,7 cc/min at 70 bar.
- Typical response 2 ms.
- Control pilot flow = RVCS: 0,11 to 0,16 L/min.; RVES, RVIS, RVGS: 0,25 to 0,33 L/min.
- Factory pressure setting established at 15 L/min.
- Will accept maximum pressure at port 2; suitable for use in cross-port relief circuits.
- A remote pilot relief on port 3 (vent) will control the valve below its own setting.
- Back pressure on the tank port (port 2) is directly additive to the valve setting at a 1:1 ratio.

OPTION ORDERING INFORMATION

RV * S - * * *

<p><i>Nominal Capacity</i></p> <p>C 60 L/min.</p> <p>E 95 L/min.</p> <p>G 200 L/min.</p> <p>I 480 L/min.</p>	<p><i>Control**</i></p> <p>C* Tamper Resistant Factory Set</p> <p>K Handknob with Lock Knob</p> <p>L Standard Screw Adjustment</p> <p><i>* Special setting required. Specify at time of order.</i></p> <p><i>** See page 178 for information on Control Options</i></p> <p><i>Customer specified special setting stamped on hex.</i></p>	<p><i>Adjustment Range</i></p> <p>A 7 - 210 bar Standard set at 70 bar</p> <p>B 3,5 - 105 bar Standard set at 70 bar</p> <p>C 10,5 - 420 bar Standard set at 70 bar</p> <p>N 4 - 55 bar Standard set at 25 bar</p> <p>Q 4 - 25 bar Standard set at 14 bar</p> <p>W 10,5 - 315 bar Standard set at 70 bar</p>	<p><i>Seal Material</i></p> <p>N Buna-N</p> <p>V Viton</p>
--	---	--	--

Visit www.sunhydraulics.com for current list pricing and complete technical information on all Sun products.



PILOT OPERATED, BALANCED POPPET, VENTABLE, SOFT

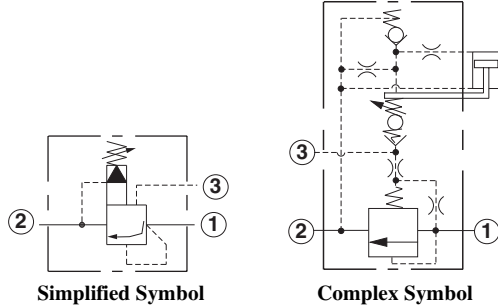
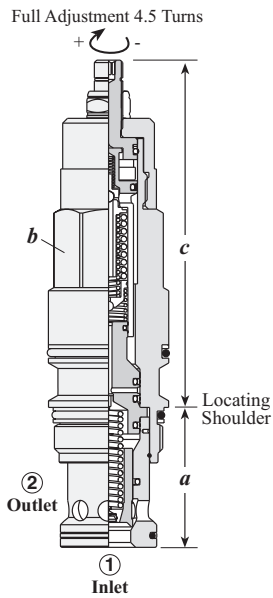

Capacity	Typical Cartridge Model Code	Cavity	Cartridge Dimensions				Installation Torque (Nm)
			a	b	L	C	
120 L/min.	RVET - LAN	T - 2A	35,1	28,6	110,2	113,5	60 - 70
240 L/min.	RVGT - LAN	T - 17A	46,0	31,8	114,3	116,8	200 - 215
480 L/min.	RVIT - LAN	T - 19A	63,5	35,1	115,6	120,1	465 - 500

Performance Curves

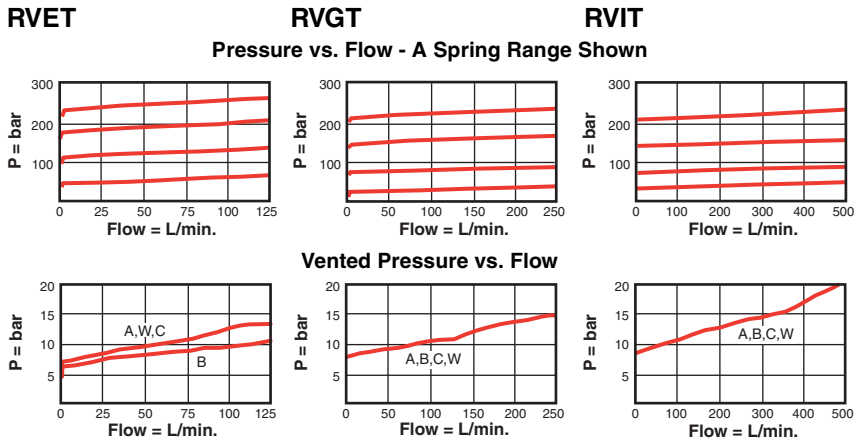

- Maximum operating pressure = 350 bar.
- Control pilot flow = RVET: 0,16 to 0,41 L/min.; RVGT, RVIT: 0,25 to 0,33 L/min.
- Pressure ramp up time = RVET: 300 ms.; RVGT: 400 ms.; RVIT: 500 ms.
- Typical response time 2 ms.
- Factory pressure setting established at 15 L/min.
- Will accept maximum pressure at port 2; suitable for use in cross-port relief circuits.
- A remote pilot relief on port 3 (vent) will control the valve below its own setting.

OPTION ORDERING INFORMATION

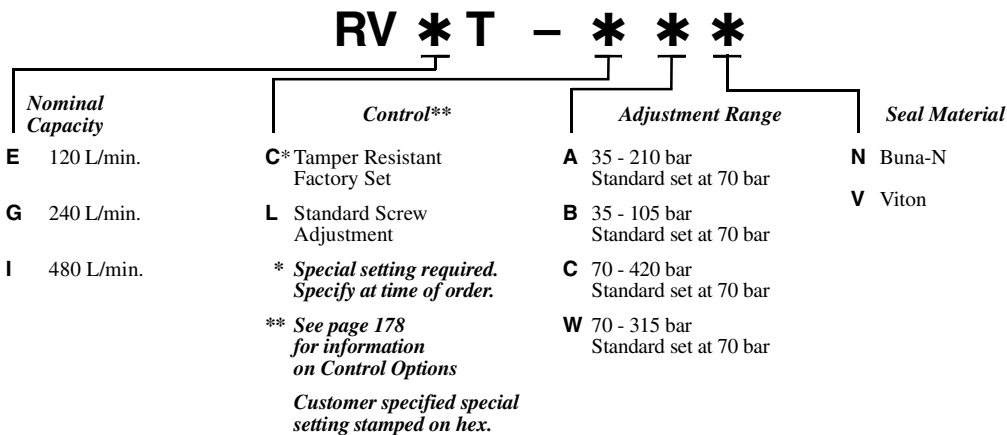

Visit www.sunhydraulics.com for current list pricing and complete technical information on all Sun products.

BYPASS COMPENSATOR WITH RELIEF FUNCTION, NORMALLY CLOSED

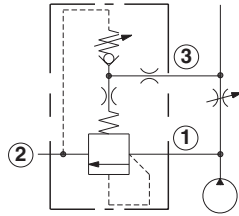
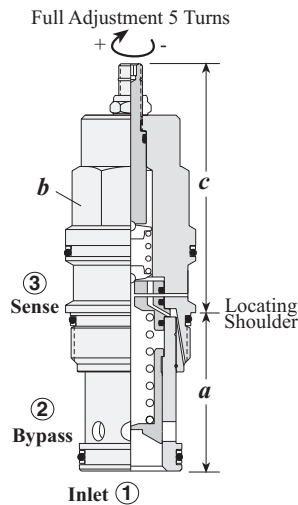

Capacity	Typical Cartridge Model Code	Cavity	Cartridge Dimensions					Installation Torque (Nm)
			a	b	c			
					L	C	K	
20 L/min.	RVBB - LAN	T - 163A	30,7	19,1	64,5	66,8	70,4	35 - 40
40 L/min.	RVCB - LAN	T - 11A	35,1	22,2	63,5	65,3	69,3	45 - 50
80 L/min.	RVEB - LAN	T - 2A	35,1	28,6	71,4	73,2	77,7	60 - 70
160 L/min.	RVGB - LAN	T - 17A	46,0	31,8	83,3	84,1	89,7	200 - 215
320 L/min.	RVIB - LAN	T - 19A	63,8	41,3	100,0	103,1	105,9	465 - 500

Performance Curves

RVBB

RVCB

RVEB

RVGB

RVIB

Typical Compensator Differentials

The X axis of the performance curves shown indicates the system pressure. The Y axis of the performance curves indicates the pressure differential that the valve creates across the control orifice. The curves represent various bypass flows (pump flow minus control flow). The capacities listed and performance of these valves are determined by the bypass flow. The control flow is not a factor.

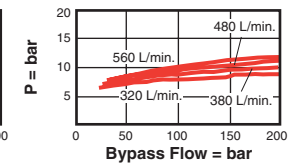
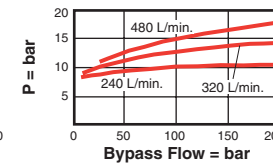
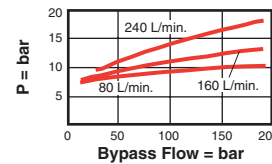
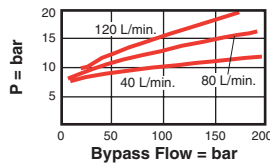
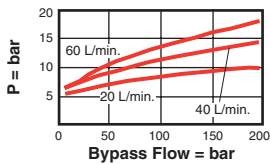

- Maximum operating pressure = 350 bar.
- Maximum valve leakage at 24 cSt = RVBB, RVCB: 30 cc/min. at 70 bar; RVEB: 50 cc/min. at 70 bar; RVGB: 65 cc/min. at 70 bar; RVIB: 80 cc/min. at 70 bar.
- Typical response time 10 ms.
- Factory pressure setting established at 15 L/min.
- Back pressure on the tank port (port 2) is directly additive to the valve setting at a 1:1 ratio.
- Compensating pressure for all ranges is 8 bar.

OPTION ORDERING INFORMATION

Nominal Capacity	Control**	Adjustment Range	Seal Material
B 20 L/min.	L Standard Screw Adjustment	RVBB only: A 5 - 210 bar Standard set at 70 bar	N Buna-N
C 40 L/min.	C* Tamper Resistant Factory Set	B 5 - 105 bar Standard set at 70 bar	V Viton
E 80 L/min.	K Handknob with Lock Knob	C 5 - 420 bar Standard set at 70 bar	<i>Consult the Sun website for our most recent and complete information on the full Corrosion Resistant line of products.</i>
G 160 L/min.		N 5 - 55 bar Standard set at 30 bar	
I 320 L/min.		Q 5 - 25 bar Standard set at 14 bar	
		W 5 - 315 bar Standard set at 70 bar	
		RVCB, RVEB, RVGB, RVIB only: A 7 - 210 bar Standard set at 70 bar	
		C 10,5 - 420 bar Standard set at 70 bar	Adjustment Ranges (Continued)
		D 2 - 55 bar Standard set at 30 bar	B 3,5 - 105 bar Standard set at 70 bar RVCB, bias pressure is 4 bar.
			RVCB, RVEB only: W 7 - 315 bar Standard set at 70 bar

Visit www.sunhydraulics.com for current list pricing and complete technical information on all Sun products.

PILOT OPERATED, BALANCED PISTON, VENTABLE WITH EXTERNAL DRAIN

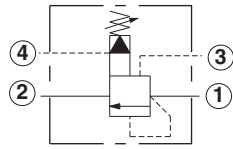
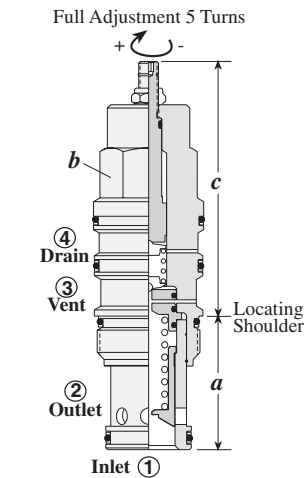

Capacity	Typical Cartridge Model Code	Cavity	Cartridge Dimensions					Installation Torque (Nm)
			a	b	c			
60 L/min.	RVCD – LAN	T - 21A	35,1	22,2	L	C	K	45 - 50
120 L/min.	RVED – LAN	T - 22A	35,1	28,6	87,4	89,0	93,7	60 - 70
240 L/min.	RVGD – LAN	T - 23A	46,0	31,8	99,8	101,3	106,4	200 - 215
480 L/min.	RVID – LAN	T - 24A	63,5	41,8	121,4	126,7	127,8	465 - 500

Performance Curves

RVCD

RVED

RVGD

RVID

Typical Pressure Rise

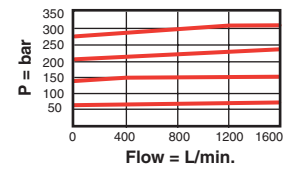
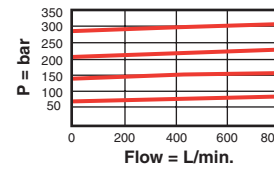
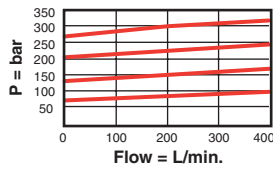
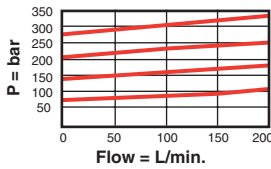

Vented Pressure

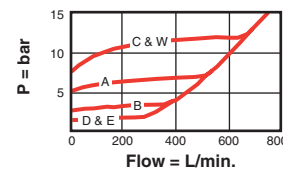
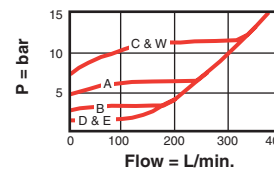
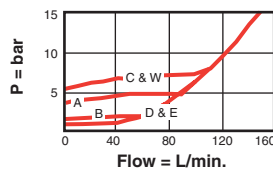
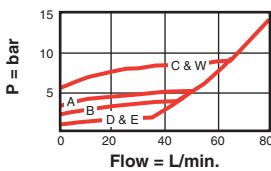

- Maximum operating pressure = 350 bar.
- Maximum valve leakage at 24 cSt = RVCD: 30 cc/min. at 70 bar; RVED: 50 cc/min. at 70 bar; RVGD: 65 cc/min. at 70 bar; RVID: 80 cc/min. at 70 bar.
- Control pilot flow = RVCD: 0,11 to 0,16 L/min.; RVED: 0,16 to 0,25 L/min.; RVGD, RVID: 0,25 to 0,33 L/min.
- Typical response time 10 ms.
- Factory pressure setting established at 15 L/min.
- Pressure at port 4 is directly additive to the valve setting at a 1:1 ratio and should not exceed 350 bar.
- Will accept maximum pressure at port 2; suitable for use in cross-port relief circuits.

OPTION ORDERING INFORMATION

RV * D - * * *			
Nominal Capacity	Control**	Adjustment Range	Seal Material
C 60 L/min.	L Standard Screw Adjustment	A 7 - 210 bar Standard set at 70 bar	N Buna-N
E 120 L/min.	C* Tamper Resistant Factory Set	B 3,5 - 105 bar Standard set at 70 bar	V Viton
G 240 L/min.	K Handknob with Lock Knob	C 10,5 - 420 bar Standard set at 70 bar	
I 480 L/min.	* <i>Special setting required. Specify at time of order.</i>	D 1,7 - 55 bar Standard set at 30 bar	
	** <i>See page 178 for information on Control Options</i>	E 1,7 - 28 bar Standard set at 14 bar	
	<i>Customer specified special setting stamped on hex.</i>	W 10,5 - 315 bar Standard set at 70 bar	

Visit www.sunhydraulics.com for current list pricing and complete technical information on all Sun products.

PILOT OPERATED, BALANCED PISTON, VENTABLE, DRAIN TO PORT 4, MAIN STAGE WITH INTEGRAL T-8A CONTROL CAVITY

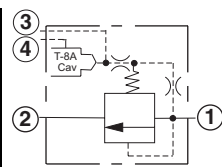
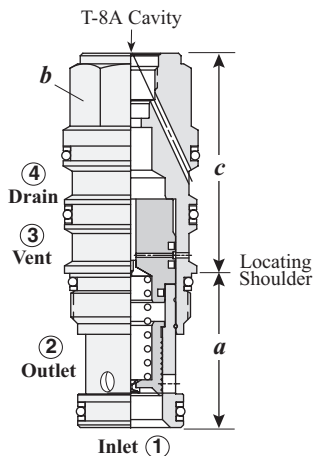

The -8 control option allows a pilot control valve to be incorporated directly into the end of the relief cartridge via the T-8A cavity. These pilot control cartridges are sold separately and include electro-proportional, solenoid, air pilot, and hydraulic pilot operation. See Pilot Control Cartridges on page 141.

Capacity	Typical Cartridge Model Code	Cavity	Cartridge Dimensions			Installation Torque (Nm)
			a	b	c	
60 L/min.	RVCD - 8WN	T - 21A	35,1	22,2	45,2	45 - 50
120 L/min.	RVED - 8WN	T - 22A	35,1	28,6	50,8	60 - 70
240 L/min.	RVGD - 8WN	T - 23A	46,0	31,8	65,8	200 - 215
480 L/min.	RVID - 8WN	T - 24A	63,5	41,3	80,3	465 - 500

Performance Curves

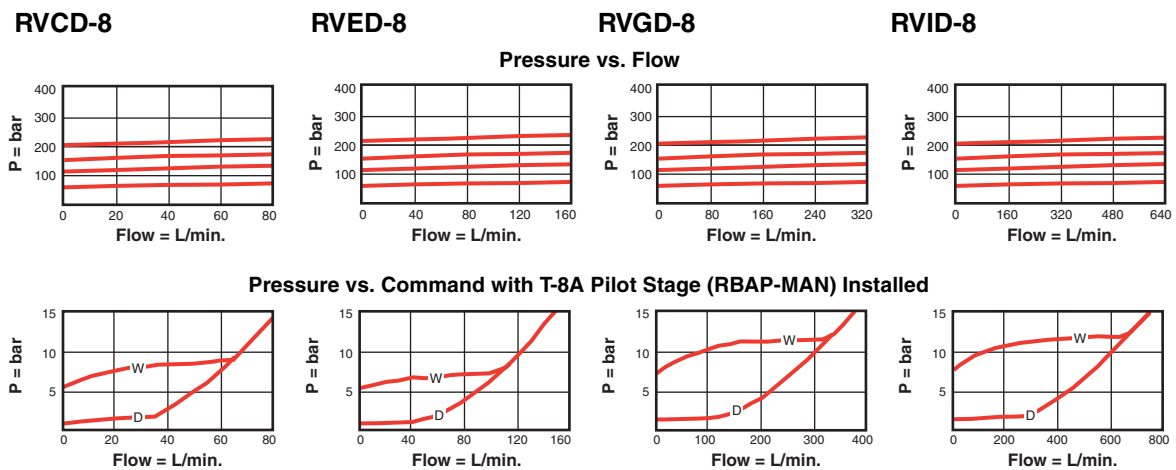

- Maximum operating pressure = 350 bar.
- Main stage leakage at 24 cSt = RVCD-8: 30 cc/min. at 70 bar; RVED-8: 50 cc/min. at 70 bar; RVGD-8: 65 cc/min. at 70 bar; RVID-8: 80 cc/min. at 70 bar.
- Control pilot flow = RVCD-8: 0,11 to 0,16 L/min.; RVED-8: 0,16 to 0,25 L/min.; RVGD-8, RVID-8: 0,25 to 0,33 L/min.
- Typical response time 10 ms.
- Will accept maximum pressure at port 2; suitable for use in cross-port relief circuits.
- Pressure at port 4 is directly additive to the valve setting at a 1:1 ratio and should not exceed 350 bar.

OPTION ORDERING INFORMATION

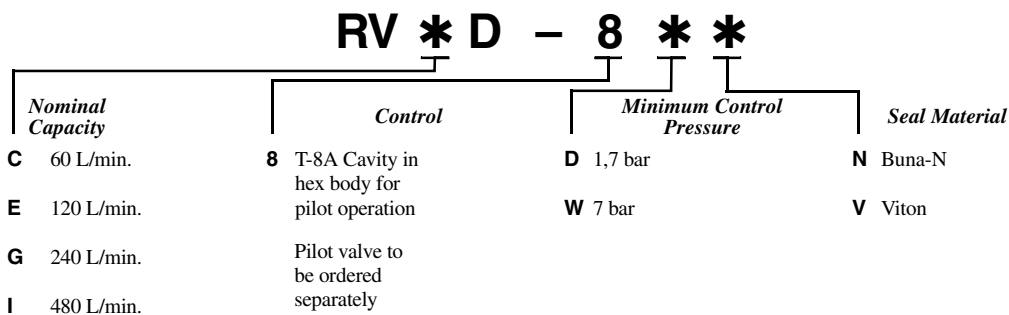

Visit www.sunhydraulics.com for current list pricing and complete technical information on all Sun products.

Protection against pressure spikes. . .

NEW SOFT SHIFT OPTION FOR SUN RELIEF CARTRIDGE VALVES

Using these newly designed pressure relief valves, pressures can be ramped up and ramped down. These relief valves work purely mechanically, and protect hydraulic components against pressure spikes that could damage machinery. Soft shift relief valves are available as pure pressure relief valves and as ventable relief valves in different frame sizes. As cartridge valves they can be used in many different types of assemblies such as sandwich, line mount, gasket mount, and custom.

Benefits of Sun's Soft Relief

- **Controlled rate of pressure rise means less dynamic stress for components.**
 - No pressure transients above setting.
 - Limited rate of force change.
 - Increases the life expectancy of hoses and other critical components in the circuit.
- **Uses a normally open pilot section to maintain a minimum threshold setting.**
 - A minimum threshold setting allows the valve to begin controlling the rate of pressure rise immediately from the vent pressure setting.
 - Incorporates a return spring to ensure a reliable reset.

*See catalogue pages 11 (RP*T) and 20 (RV*T) for detailed information on relief cartridges with soft shift options.*



Soft Shift option extended to Sun Solenoid Operated Directional Valves. . .

Sun's small pilot solenoid valves are used to unload larger main-stage elements remotely, or by directly integrating the pilot valve into the main-stage element. In this latter approach, unique to Sun, 12 different pilot valves (proportional, solenoid, hydraulic and pneumatic) can be integrated into a variety of main-stage elements.

Most 2-position, 2-way screw-in cartridge pilot solenoid valves utilize a poppet style construction to satisfy low leakage requirements. Sun Hydraulics has adopted a different approach that utilizes a precision spool/sleeve design. Available in both 2-position, 2- and 3-way pilot solenoid cartridges, this approach produces leakage characteristics equivalent to poppet style designs.

Since control volumes in pilot circuits are typically small, the lower gain characteristics of spool valves produce a softer unload. To further extend the operating rate, Sun offers a soft shift option that adds an orifice in the valve's armature to gain greater control of fluid displacement. Combining the benefits of a spool valve with the soft shift option extends shift times, which can reduce the hydraulic shock generated when unloading main-stage elements. Sun's Soft Shift option is offered on all of its spool-type solenoid valves.

You will find additional information about the DTDA-S, DAAL-S, DLDA-S, DBAL-S, DMDA-S, DNDA-S on pages 132 through 138 in the Solenoid section of this catalogue.

Consult the Sun website
www.sunhydraulics.com

for detailed and complete information on Sun soft shift options.

Products: Cartridges: Relief: View All Relief Cartridges and Products: Cartridges: Solenoids: View all Solenoid Operated Cartridges.
Products: Cartridges: Solenoid Operated: View All Solenoid Operated Cartridges

