



FR-1 series

Tank top return filters



Technical Information

Housing

Pressure: Max working 8 bar (116 psi) (acc. to NFPA T 3.10.5.1)
Burst 16 bar (232 psi) (acc. to NFPA T 3.10.5.1)

Connection Ports: 3/8" ÷ 2" BSP (other thread options on request)

Materials: Cover: aluminium alloy
Head: aluminium alloy
Bowl: nylon (size 10 to 43) - zinc plated steel (size 50 to 64)
Seal: NBR (FKM on request)

By-pass: 1,7 bar (24.6 psi)

Element

Filter Media: Microglass fiber 4,5 - 7 - 12 - 27 $\mu\text{m}_{(c)}$ (acc. to ISO 16889)
Cellulose 10 - 25 $\mu\text{m}_{(c)}$ (acc. to ISO 16889)
Wire mesh 60 - 125 μm

Differential collapse pressure: 10 bar (145 psi) (acc. to ISO 2941)

Filtrec elements are tested also according to ISO 2942, ISO 23181 and ISO 3968

Common

Working temperature: -25°C +100°C (-13°F +212°F)

Fluid compatibility (acc. to ISO 2943):

Full with HH-HL-HM-HV (acc. to ISO 6743/4).

For use with other fluid applications please contact Filtrec Customer Service (info@filtrec.it).

Ordering information

MEDIA	
000	no element
G03	microglass fiber $\beta_{4,5 \mu\text{m} (c)} \geq 1000$
G06	microglass fiber $\beta_{7 \mu\text{m} (c)} \geq 1000$
G10	microglass fiber $\beta_{12 \mu\text{m} (c)} \geq 1000$
G25	microglass fiber $\beta_{27 \mu\text{m} (c)} \geq 1000$
C10	cellulose $\beta_{10 \mu\text{m} (c)} \geq 2$
C25	cellulose $\beta_{25 \mu\text{m} (c)} \geq 2$
T60	wire mesh 60 μm
T125	wire mesh 125 μm

	NOMINAL SIZE	MEDIA		SEALS	CONNECTION	FILLING PLUG	INDICATOR POSITION	INDICATOR
Filter assembly FR-1	30	G10	B	B	B4	0	C	R10
Filter element R-1	30	G10	B	B				

SEALS

B	NBR (omit for spare element)
V	FKM

CONNECTION

B2	3/8" BSP
B3	1/2" BSP
B4	3/4" BSP
B5	1" BSP
B6	1 1/4" BSP
B7	1 1/2" BSP
B8	2" BSP

For different thread options please check availability with Filtrtec Customer Service.

FILLING PLUG

0	no filling plug
T	with filling plug

INDICATOR POSITION

0	no indicator - no hole
C	on the cover+plug

INDICATOR

000	no indicator
R2	pressure switch N.O. 1,3 bar / 18,9 psi
R3	pressure switch N.C. 1,3 bar / 18,9 psi
R6	visual pressure 1,3 bar / 18,9 psi
R7	pressure vacuum gauge -1 ÷ 5 bar / -14,5 ÷ 72,5 psi
R9	pressure gauge 0 ÷ 4 bar / 0 ÷ 58 psi
R10	pressure gauge 0 ÷ 4 bar / 0 ÷ 58 psi

Preferential option

Overall dimensions

FR - 1 - 10 / 11 / 20 / 22 / 30 / 31 TANK MOUNTING PATTERN

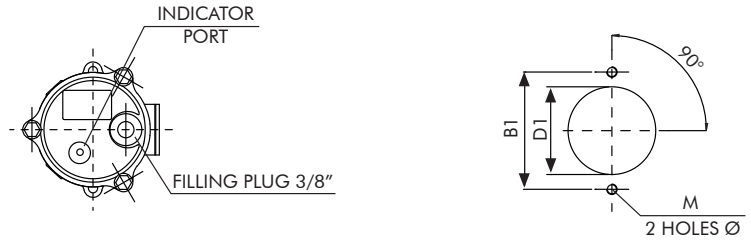

FR - 1 - 40 / 43 TANK MOUNTING PATTERN

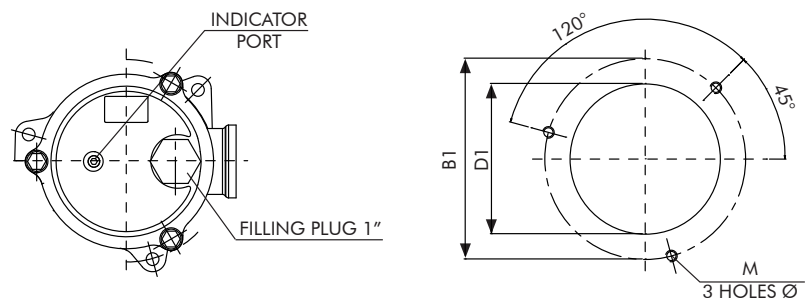

FR - 1 - 50 / 51 / 60 / 64 TANK MOUNTING PATTERN

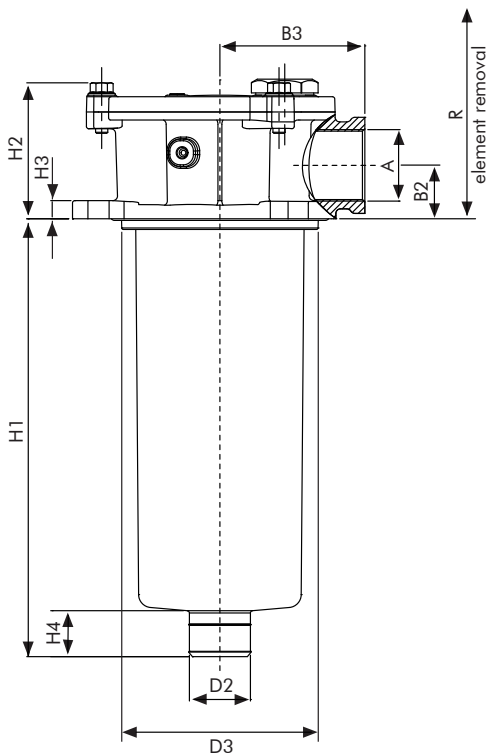
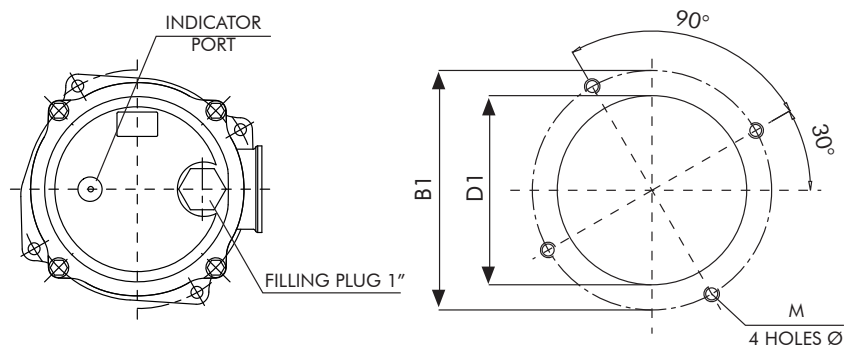

Nominal size

CODE	A	B1	B2	B3	D1	D2	D3	H1	H2	H3	H4	M	R	WEIGHT
FR-1-10	3/8"-1/2" BSP	89	25	51	67,5	24	67	82	60	8	22	M6	150	0,45 Kg
155								220						0,60 Kg
FR-1-20	1/2"-3/4" BSP	115	28,5	67	88,5	28	87	106	73	24	M8	190	0,80 Kg	
FR-1-22								151					230	0,90 Kg
FR-1-30	3/4"-1" BSP	115	28,5	67	88,5	40	87	232	73	24	M8	310	1,10 Kg	
FR-1-31								336					420	1,30 Kg
FR-1-40	1"-1 1/4"-1 1/2" BSP	175	35	95	130	40	129	241	90	11	30	M10	320	2,10 Kg
FR-1-43								287						360
FR-1-50	1 1/4"-1 1/2"-2" BSP	220	42	115	175	50	174	181	105	50	M10	270	3,20 Kg	
FR-1-51								240					340	3,60 Kg
FR-1-60	1 1/2" -2" BSP	220	42	115	175	63	174	240	105	50	M10	340	3,60 Kg	
FR-1-64								289					380	4,20 Kg

FR-1 series

Pressure drop diagrams

The total Pressure Drop (Δp) value is obtained by adding the Δp values of filter housing and filter element at the given flow rate. This ideally should not exceed 0,5 bar (7,3 psi) and should never exceed 1/3 of the set value of the by-pass valve.

PRESSURE DROP THROUGH THE FILTER HOUSING

The Pressure Drop through the filter housing is governed by the port, not the bowl length and the oil viscosity.

PRESSURE DROP THROUGH THE CLEAN FILTER ELEMENT

The Pressure Drop through the filter element is related both to the internal diameter of the filter element and to the filter media; this value is affected by the oil viscosity in a roughly proportional way: e.g. when the Δp value from the curve is 0,2 bar and a 46 cSt oil is used, the corresponding value is 0,31 ($=0,2 \times 46/30$) bar.

Element R-1-10

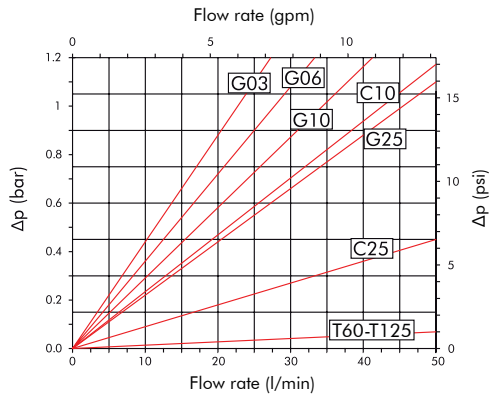

Housing FR-1-10/11

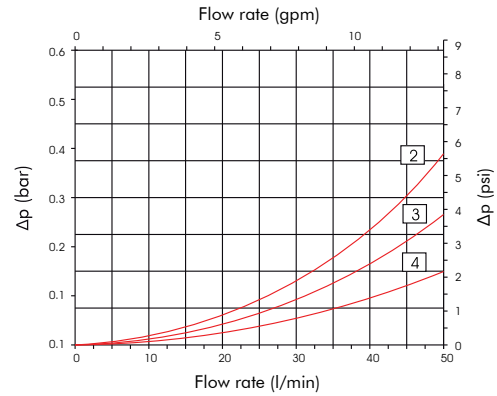

Element R-1-11

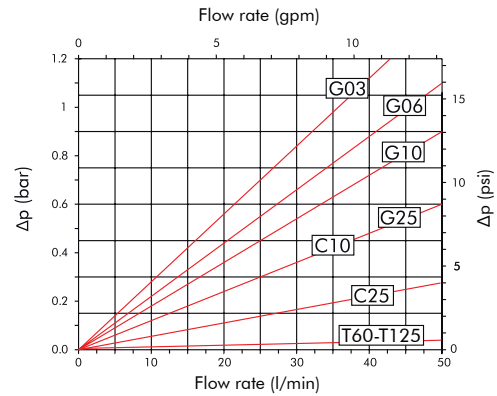

Pressure drop diagrams

PRESSURE DROP THROUGH THE FILTER HOUSING

The Pressure Drop through the filter housing is governed by the port, not the bowl length and the oil viscosity.

PRESSURE DROP THROUGH THE CLEAN FILTER ELEMENT

The Pressure Drop through the filter element is related both to the internal diameter of the filter element and to the filter media; this value is affected by the oil viscosity in a roughly proportional way: e.g. when the Δp value from the curve is 0,2 bar and a 46 cSt oil is used, the corresponding value is 0,31 ($=0,2 \times 46/30$) bar.

Housing FR-1-20/22

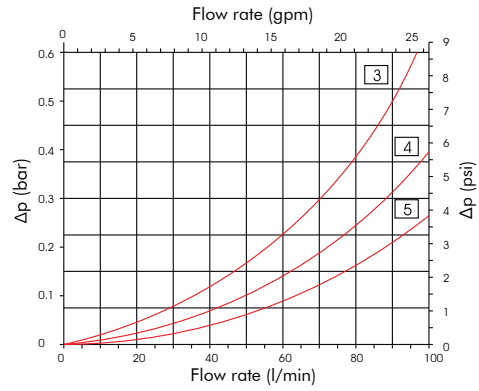

Housing FR-1-30/31

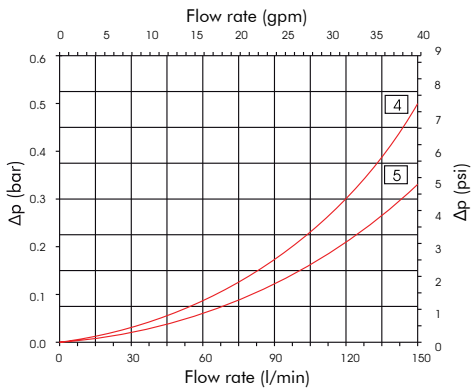

Element R-1-20

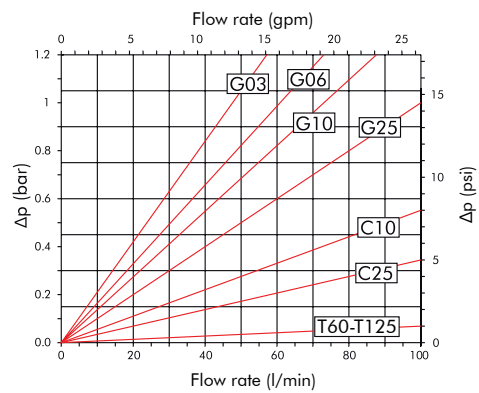

Element R-1-22

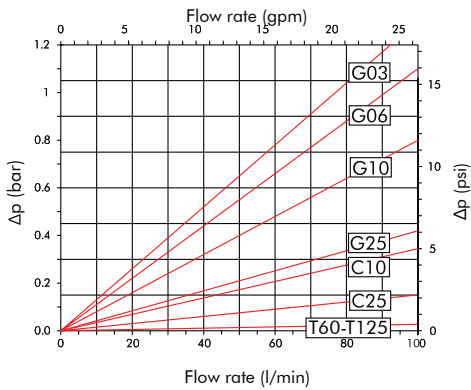

Element R-1-30

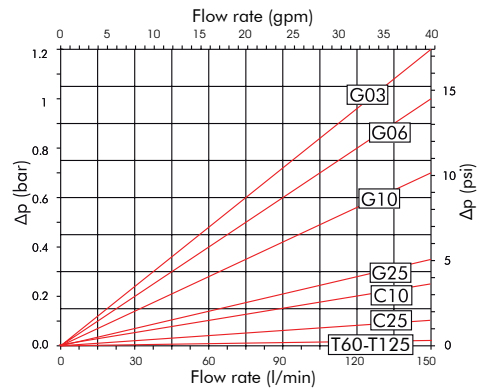

Element R-1-31

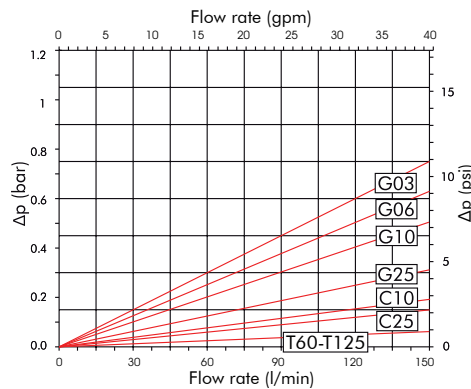

Pressure drop diagrams

PRESSURE DROP THROUGH THE FILTER HOUSING

The Pressure Drop through the filter housing is governed by the port, not the bowl length and the oil viscosity.

PRESSURE DROP THROUGH THE CLEAN FILTER ELEMENT

The Pressure Drop through the filter element is related both to the internal diameter of the filter element and to the filter media; this value is affected by the oil viscosity in a roughly proportional way: e.g. when the Dp value from the curve is 0,2 bar and a 46 cSt oil is used, the corresponding value is 0,31 (=0,2 x 46/30) bar.

Element R-1-40

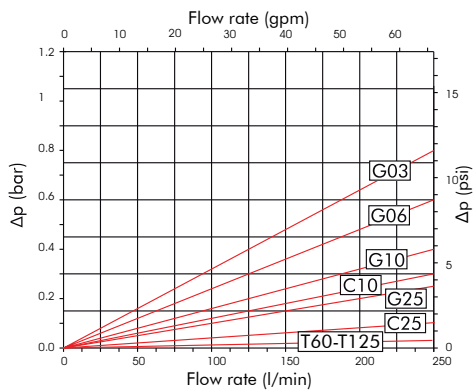

Housing FR-1-40/43

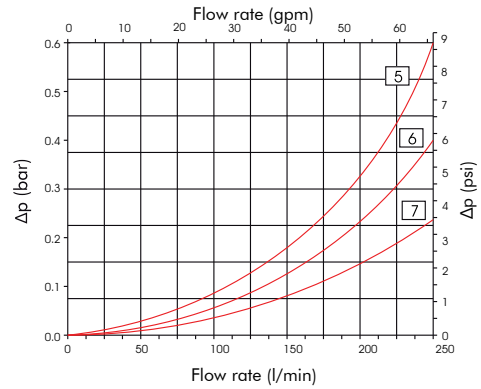

Element R-1-43

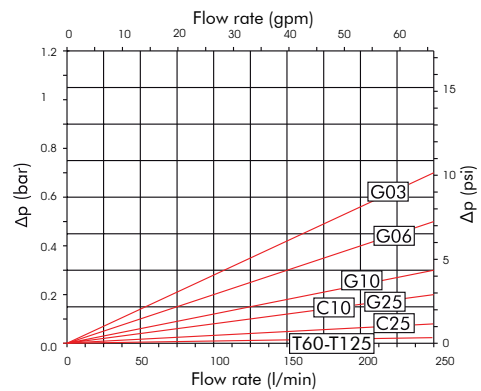

Pressure drop diagrams

PRESSURE DROP THROUGH THE FILTER HOUSING

The Pressure Drop through the filter housing is governed by the port, not the bowl length and the oil viscosity.

PRESSURE DROP THROUGH THE CLEAN FILTER ELEMENT

The Pressure Drop through the filter element is related both to the internal diameter of the filter element and to the filter media; this value is affected by the oil viscosity in a roughly proportional way: e.g. when the Δp value from the curve is 0,2 bar and a 46 cSt oil is used, the corresponding value is 0,31 ($=0,2 \times 46/30$) bar.

Housing FR-1-60/64

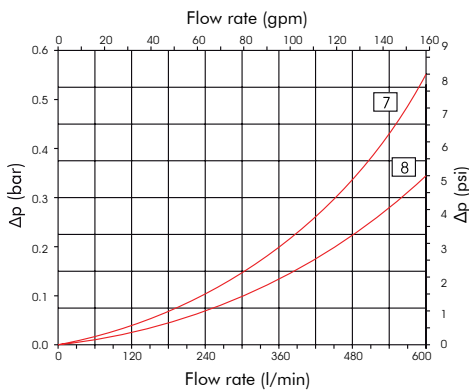

Element R-1-51

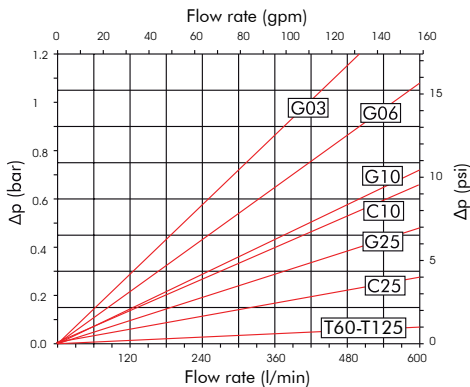

Element R-1-64

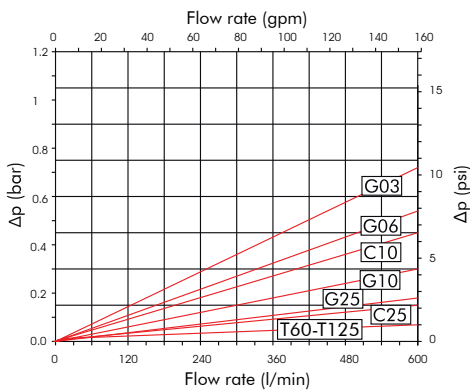

Housing FR-1-50/51

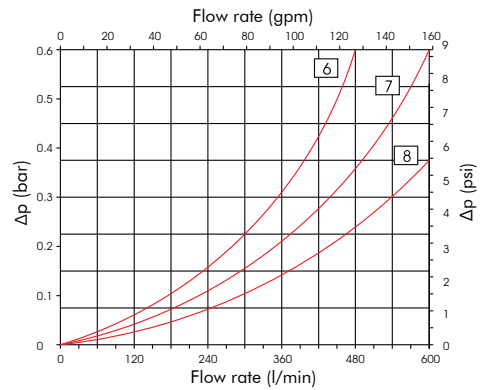

Element R-1-50

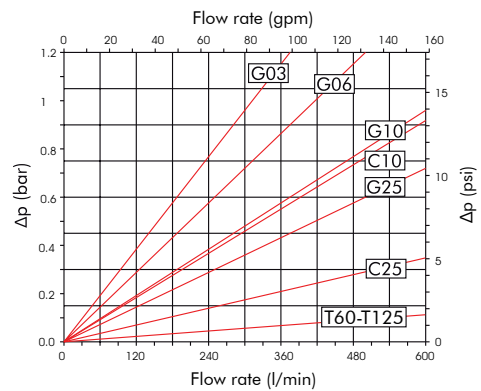

Element R-1-60

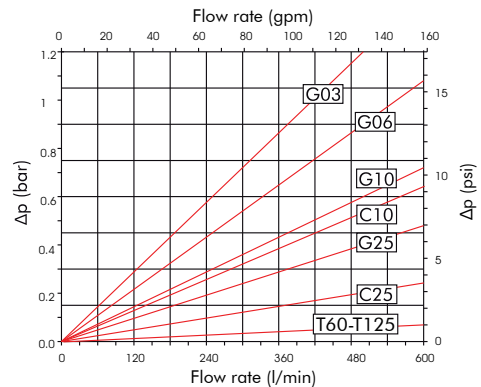

Pressure drop diagrams

PRESSURE DROP THROUGH THE BY-PASS VALVE

The by-pass valve is a safety device to prevent element collapse in case of differential pressure peaks due to flow peaks, cold start conditions or when the clogged element is not replaced in a timely manor.

By-pass FR-1-40/64

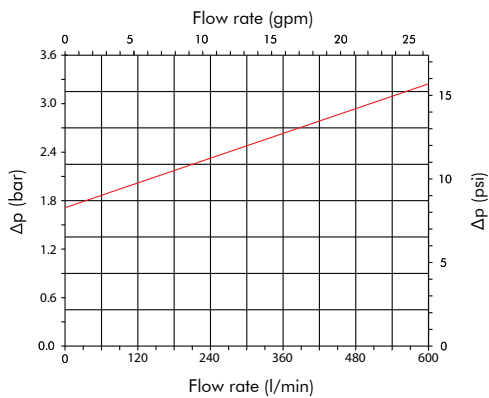

By-pass FR-1-10/31

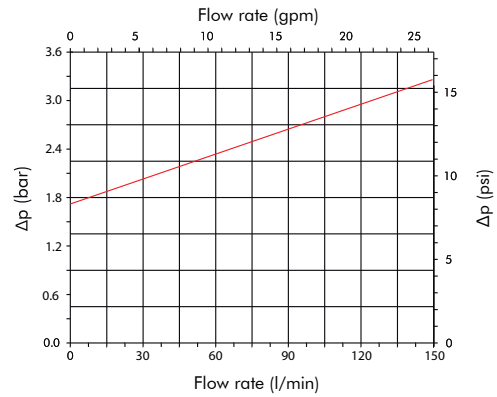

The above diagrams have been obtained at the FILTREC laboratory, according to the ISO 3968 specification, with mineral oil having 30 cSt viscosity and 0,86 Kg/dm³ density.

In case of discrepancy, please check contamination level, viscosity and features of the oil in use and the sampling points of the differential pressure.

Clogging indicator

The Pressure Drop (Δp) through the filter increases during the system operation due to the contaminant retained by the filter element.

The filter element must be replaced when the indicator shows and before the Δp reaches the by-pass value setting. N.B. in cold start conditions a false alarm can be caused by higher oil viscosity due to low temperature; the indicator alarm must be considered at normal working temperature only.

The clogging indicator registers the pressure upstream the filter element:

- in the VISUAL indicator the red area shows the need for element replacement.
- in the ELECTRIC indicator an electrical switch is activated.

PRESSURE SWITCH

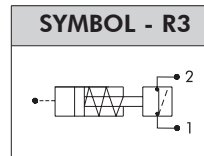
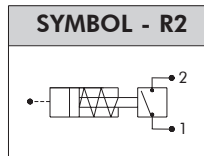
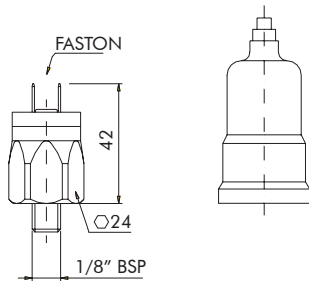

CODE	SETTING
R2	1,3 bar (18,9 psi) N.O.
R3	1,3 bar (18,9 psi) N.C.

- Current: 0,5 A resistive/ 0,2 A inductive
- Max voltage: 30-48 V DC
- Protection: IP54 as per DIN 40050

VISUAL PRESSURE GAUGE

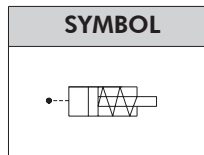
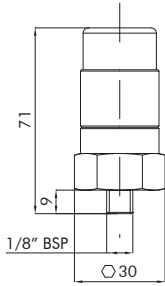

CODE	SETTING
R6	1,3 bar (18,9 psi)

PRESSURE/ VACUUM GAUGE

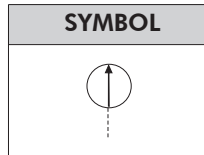
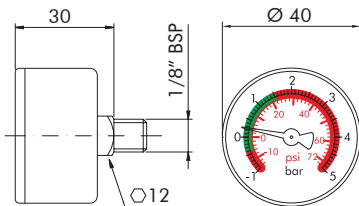

CODE	SCALE
R7	0 ÷ 1,4 bar (0 ÷ 20 psi) green sector
	1,4 ÷ 5 bar (20 ÷ 72,5 psi) red sector

Housing in black ABS material

N.B. Multipurpose product: this gauge can also be used as vacuum gauge on suction filters.

PRESSURE GAUGE

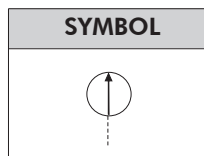
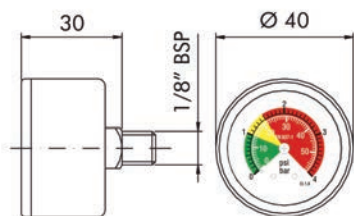

CODE	SCALE
R9	0 ÷ 1 bar (0 ÷ 14,5 psi) green sector
	1 ÷ 1,5 bar (14,5 ÷ 22 psi) yellow sector
	1,5 ÷ 4 bar (22 ÷ 58 psi) red sector

Housing in black ABS material

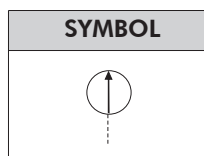
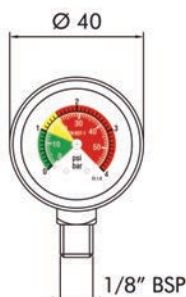

CODE	SCALE
R10	0 ÷ 1 bar (0 ÷ 14,5 psi) green sector
	1 ÷ 1,5 bar (14,5 ÷ 22 psi) yellow sector
	1,5 ÷ 4 bar (22 ÷ 58 psi) red sector

Housing in black ABS material

Preferential option

FR-1 series

User Tips

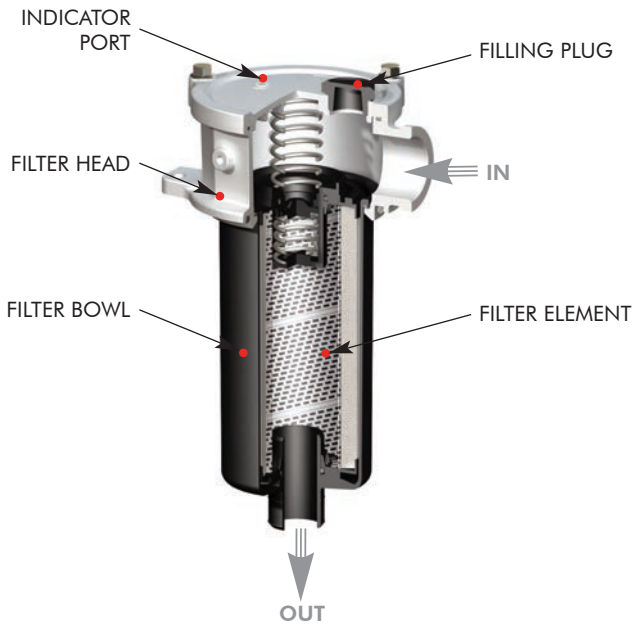

SPARE SEAL KIT PART NUMBER		
	NBR	FKM
FR-1-10/11	06.021.00170	06.021.00174
FR-1-20/22/30/31	06.021.00171	06.021.00175
FR-1-40/43	06.021.00172	06.021.00176
FR-1-50/51/60/64	06.021.00173	06.021.00177

FIXING BOLTS TIGHTENING TORQUE	
M6	10 Nm
M8	25 Nm
M10	50 Nm

Installation

Make sure that the filter flange is well secured on the tank lid through the fixing holes and that the hose is properly connected to the IN port; verify that the OUT port is clear (in this port an extension tube can be fitted, so that the outlet is below the oil level). After mounting verify that no tension is present on the filter. Make sure that enough space is available for filter element replacement and that the clogging indicator is in a easily viewable position. If an electrical indicator is used, make sure that it is properly wired.

We recommend the stocking of a spare FILTREC filter element for timely replacement when required.

Maintenance

Before removing the top cover, ensure that the system is switched off and there is no residual pressure in the filter. Unscrew the fixing bolts of the top cover and remove it. Remove the spring first and then the dirty filter element pulling it carefully. Clean the bowl and fit a new FILTREC element, verifying the part number, particularly concerning the micron rating. When fitting the new element, open the plastic protection on the top and insert the element over the spigot in the filter bowl, then remove completely the plastic protection. Check the top cover gasket conditions and replace if necessary; put the spring in its position over the filter element and then mount the top cover and fix it screwing the fixing bolts.

N.B. The used filter elements cannot be cleaned and re-used.

Operation

Make sure that the filter works within the conditions of pressure, temperature and fluid compatibility given in the first page of this data sheet. The filter element must be replaced as soon as the clogging indicator signals at working temperature (in cold start conditions, oil temperature lower than 30°C, a false alarm can be given due to oil viscosity). If no clogging indicator is mounted, make sure that the cartridge is replaced according to the system manufacturer's recommendations.

PED Compliance

FR-1 filters conform to PED 97/23/CE norm, article 3 section 3, and so they can be used with fluids of group 2 (liquids with steam pressure < 0,5 bar at the maximum allowable temperature, article 3, section 1.1(b) – sub-section II).

WARNING

Make sure that Personal Protective Equipment (PPE) is worn during installation and maintenance operation.

Disposal of filter elements

The used filter elements and the filter parts dirty of oil are classified as "Dangerous waste material": they must be disposed according to the local laws by authorized Companies.



FR-1 series

www.filtrec.com

