

FireLock® V27, K80

Models V2703, V2704, V2725, V2726, V2727, V2728

Upright, Pendent, Recessed Pendent and Conventional Standard and Quick Response



V2725¹ (G4020048, Nr1264/2002) and V2726¹ (G4020045, Nr1263/2002)
Conventional

V2727 (G4020047, Nr1266/2002) and V2728 (G4020044, Nr1265/2002)
Pendent

V2703² (G4020046, Nr1268/2002) and V2704² (G4020043, Nr1267/2002)
Upright

Models: V2703, V2704, V2725, V2726, V2727, V2728

Style: Pendent, Upright or Conventional

K Factor: 5.6 Imp./8.1 S.I.³

Nominal Thread Size: ½" NPT/15 mm BSP

Max. Working Pressure: 175 psi/12.5 Bar

Factory Hydrostatic Test: 100% @ 500 psi/34.5 Bar

Min. Operating Pressure:

- 7 psi/48 kPa
- 0.35 bar/5 psi (VdS, CE and LPCB)

Temperature Rating: See chart

¹ cULus Listed

² cULus Listed; FM Approved

³ For K-Factor when pressure is measured in Bar, multiply S.I. units by 10.0.

Approvals/Listings:



See Victaulic Publication [10.01](#) for more details.

Product Description:

These Model V27 standard spray and conventional spray sprinklers are designed to produce a hemispherical spray pattern for standard commercial applications. They are available with either standard or quick response bulbs. The Model V27 conventional sprinkler is designed to produce a hemispherical pattern which deflects approximately half of the spray upwards toward the ceiling and the other half downwards and can be installed in either the upright or pendent position. It is cast with a hex-shaped wrench boss to allow easy tightening from many angles, reducing assembly effort. This sprinkler is available in various temperature ratings (see chart on page 3) and finishes to meet many design requirements.

Coverage

For coverage area and sprinkler placement, refer to applicable installation standards.

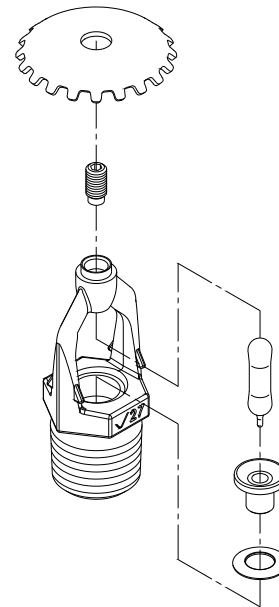

Exaggerated for clarity

Technical Specifications:

Job/Owner

System No.	
Location	

Contractor

Submitted By	
Date	

Engineer

Spec Section	
Paragraph	
Approved	
Date	

Material Specifications:

- Upright Deflector:** Bronze per UNS C22000
- Pendent Deflector:** Bronze per UNS C51000
- Conventional Deflector:** Bronze per UNS C51000
- Bulb:** Glass with glycerin solution
- Bulb Nominal Diameter:**
 - Standard Response: 5.0 mm
 - Quick Response: 3.0 mm
- Load Screw:** Bronze per UNS C65100
- Pip Cap:** Bronze per UNS C65100
- Spring:** Beryllium nickel
- Seal:** Teflon⁴ tape
- Frame:** Die cast brass 65-30
- Lodgement Spring:** Stainless steel per UNS S30200

Accessories

Installation Wrench:

- Open End: V27
- Recessed: V27-2

Sprinkler Finishes:

- Plain Brass
- Chrome plated
- White painted⁵
- Flat Black Painted⁵
- RAL 9010 Off-white⁵
- Custom painted⁵
- Proprietary Nickel Teflon⁴ coating⁵
- VC-250⁶

For cabinets and other accessories refer to separate sheet.

⁴ Teflon is a registered trademark of Dupont Co.

⁵ UL Listed for corrosion resistance.

⁶ UL Listed and FM Approved for corrosion resistance.

Approvals/Listings:

APPROVALS/LISTINGS	Model					
	V2703	V2727	V2725	V2704	V2728	V2726
Orifice Size (inches)	1/2"	1/2"	1/2"	1/2"	1/2"	1/2"
Orifice Size (mm)	13	13	13	13	13	13
Nominal K Factor Imperial	80	80	80	80	80	80
Nominal K Factor S.I. ⁷	5.6	5.6	5.6	5.6	5.6	5.6
Response	Standard	Standard	Standard	Quick	Quick	Quick
Deflector Type	Upright	Pendent	Conventional	Upright	Pendent	Conventional
Approved Temperature Ratings	F°/C°					
VdS/CE ⁸	135°F/57°C 155°F/68°C 175°F/79°C 200°F/93°C 286°F/141°C	135°F/57°C 155°F/68°C 175°F/79°C 200°F/93°C 286°F/141°C	135°F/57°C 155°F/68°C 175°F/79°C 200°F/93°C 286°F/141°C	135°F/57°C 155°F/68°C 175°F/79°C 200°F/93°C 286°F/141°C	135°F/57°C 155°F/68°C 175°F/79°C 200°F/93°C 286°F/141°C	135°F/57°C 155°F/68°C 175°F/79°C 200°F/93°C 286°F/141°C
LPCB	135°F/57°C 155°F/68°C 175°F/79°C 200°F/93°C 286°F/141°C 360°F/182°C	135°F/57°C 155°F/68°C 175°F/79°C 200°F/93°C 286°F/141°C 360°F/182°C	135°F/57°C 155°F/68°C 175°F/79°C 200°F/93°C 286°F/141°C 360°F/182°C	135°F/57°C 155°F/68°C 175°F/79°C 200°F/93°C 286°F/141°C	135°F/57°C 155°F/68°C 175°F/79°C 200°F/93°C 286°F/141°C	135°F/57°C 155°F/68°C 175°F/79°C 200°F/93°C 286°F/141°C
FM	135°F/57°C 155°F/68°C 175°F/79°C 200°F/93°C 286°F/141°C 360°F/182°C	None	None	135°F/57°C 155°F/68°C 175°F/79°C 200°F/93°C 286°F/141°C	None	None
cULus	135°F/57°C 155°F/68°C 175°F/79°C 200°F/93°C 286°F/141°C 360°F/182°C	None	135°F/57°C 155°F/68°C 175°F/79°C 200°F/93°C 286°F/141°C 360°F/182°C	135°F/57°C 155°F/68°C 175°F/79°C 200°F/93°C 286°F/141°C	None	135°F/57°C 155°F/68°C 175°F/79°C 200°F/93°C 286°F/141°C
NYC/MEA #62-99-E	135°F/57°C 155°F/68°C 175°F/79°C 200°F/93°C 286°F/141°C 360°F/182°C	None	135°F/57°C 155°F/68°C 175°F/79°C 200°F/93°C 286°F/141°C 360°F/182°C	135°F/57°C 155°F/68°C 175°F/79°C 200°F/93°C 286°F/141°C	None	135°F/57°C 155°F/68°C 175°F/79°C 200°F/93°C
CSFM #7690-0531:112	135°F/57°C 155°F/68°C 175°F/79°C 200°F/93°C 286°F/141°C 360°F/182°C	None	135°F/57°C 155°F/68°C 175°F/79°C 200°F/93°C 286°F/141°C 360°F/182°C	135°F/57°C 155°F/68°C 175°F/79°C 200°F/93°C 286°F/141°C	None	135°F/57°C 155°F/68°C 175°F/79°C 200°F/93°C

⁷ For K-Factor when pressure is measured in kPa (S.I.), divide K-Factor bar (S.I.) units by 10.0.

⁸ CE: Tested to EN12259-1 Standards

Note: Listings and Approvals as of printing. All are approved open.

Dimensions:

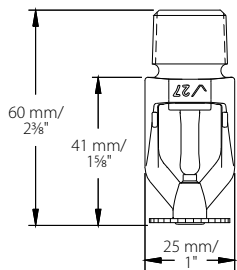

Standard Pendent –
V2727, V2728

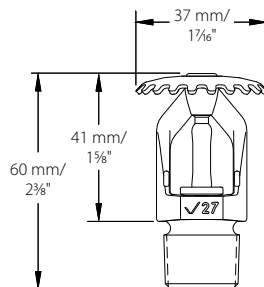

Standard Upright –
V2703, V2704

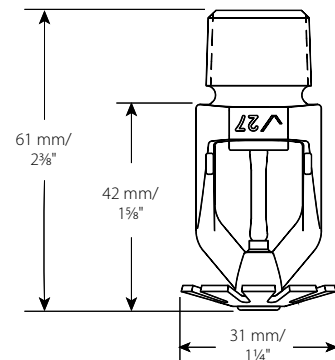

Conventional Pendent/Upright –
V2725, V2726

Distribution Patterns:

Models V2727, V2728
K80 VdS/CE Spray Pendent
Distribution Patterns – Trajectory

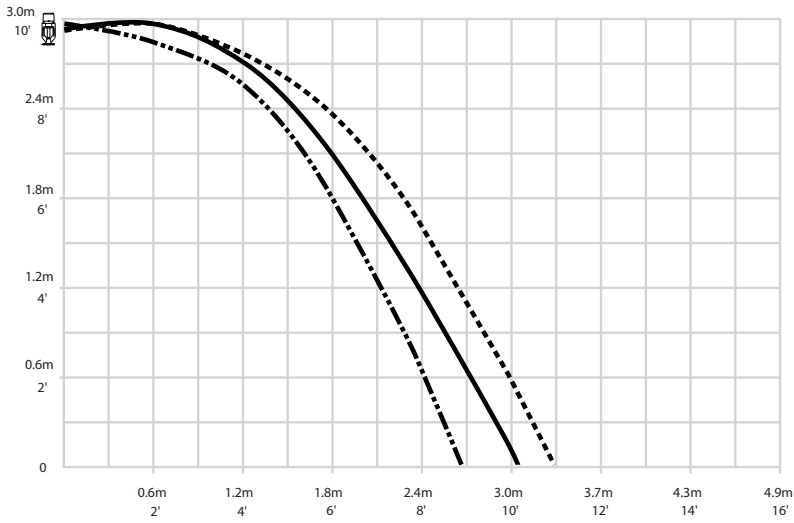

7 psi
48 kPa
15 psi
103 kPa
30 psi
207 kPa

Models V2703, V2704
K80 Standard Upright
Distribution Patterns – Trajectory

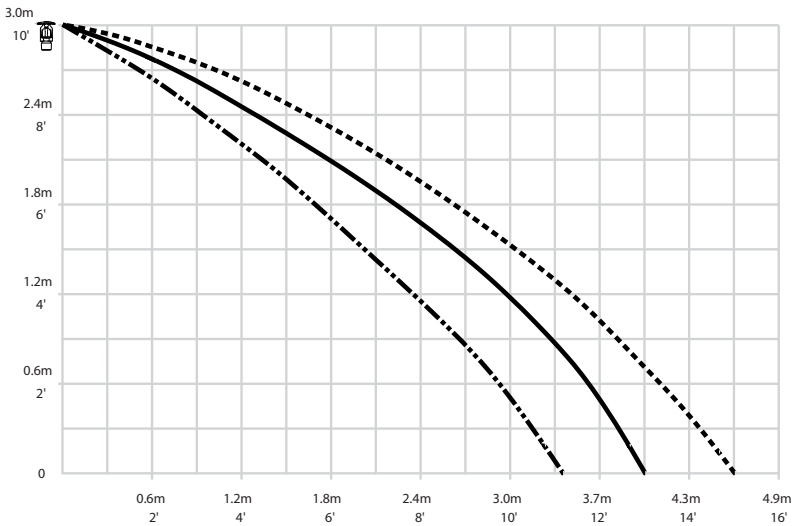

7 psi
48 kPa
15 psi
103 kPa
30 psi
207 kPa

Distribution Patterns:

Models V2725, V2726
K80 Conventional Pendent
Distribution Patterns – Trajectory

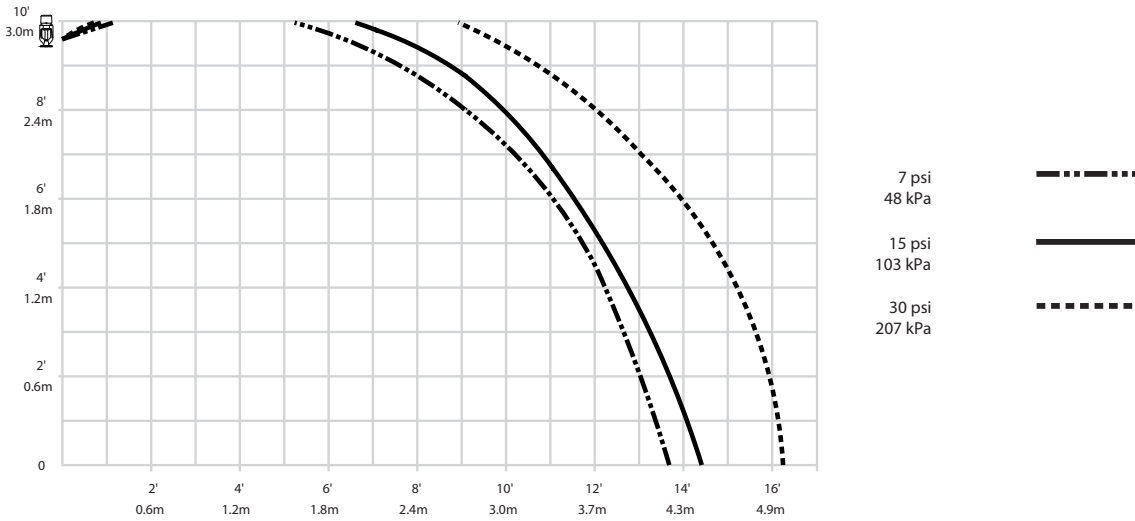

Models V2725, V2726
K80 Conventional Upright
Distribution Patterns – Trajectory

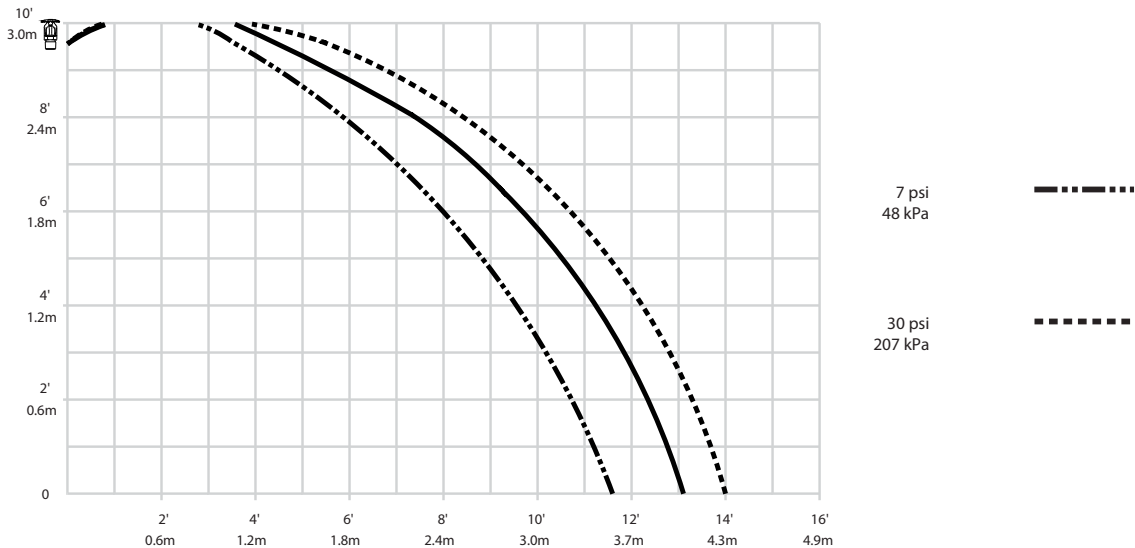

NOTES:

- A. Data shown is approximate and can vary due to differences in installation.
- B. These graphs illustrate approximate trajectories, floor-wetting, and wall-wetting patterns for these specific Victaulic FireLock Automatic Sprinklers. They are provided as information for guidance in avoiding obstructions to sprinklers and should not be used as minimum sprinkler spacing rules for installation. **Refer to the appropriate NFPA National Fire Code or the Authority Having Jurisdiction for specific information regarding obstructions, spacing limitations and area of coverage requirements.** Failure to follow these guidelines could adversely affect the performance of the sprinkler and will void all Listings, Approvals and Warranties.
- C. All patterns are symmetrical to the centerline of the waterway.

Ratings:

All glass bulbs are rated for temperatures from -67°F (-55°C) to those shown in the table below.



Sprinkler Temperature Classification	Victaulic Part Identification	Temperature – °F/°C		Glass Bulb Color
		Nominal Temperature Rating	Maximum Ambient Temperature Allowed	
Ordinary	A	135°F/57°C	100°F/38°C	Orange
Ordinary	C	155°F/68°C	100°F/38°C	Red
Intermediate	E	175°F/79°C	150°F/65°C	Yellow
Intermediate	F	200°F/93°C	150°F/65°C	Green
High	J	286°F/141°C	225°F/107°C	Blue
Extra High ⁹	K	360°F/182°C	300°F/149°C	Purple
–	M	Open	–	No Bulb

⁹ Standard response only.

Available Wrenches:

	V27-2 Recessed	V27 Open End
V2727, V2728 Pendent	✓	✓
V2725, V2726 Conventional Upright/Pendent	✓	✓
V2703, V2704 Upright	–	✓

⚠ WARNING

- Always read and understand installation, care, and maintenance instructions, supplied with each box of sprinklers, before proceeding with installation of any sprinklers.
- Always wear safety glasses and foot protection.
- Depressurize and drain the piping system before attempting to install, remove, or adjust any Victaulic piping products.
- Installation rules, especially those governing obstruction, must be strictly followed.
- Painting, plating, or any re-coating of sprinklers (other than that supplied by Victaulic) is not allowed.

Failure to follow these instructions could result in serious personal injury and/or property damage.

The owner is responsible for maintaining the fire protection system and devices in proper operating condition. For minimum maintenance and inspection requirements, refer to the current National Fire Protection Association pamphlet that describes care and maintenance of sprinkler systems. In addition, the authority having jurisdiction may have additional maintenance, testing, and inspection requirements that must be followed.

If you need additional copies of this publication, or if you have any questions about the safe installation of this product, contact Victaulic World Headquarters: P.O. Box 31, Easton, Pennsylvania 18044-0031 USA, Telephone: 001-610-559-3300.

Installation

Reference should always be made to the I-40 Victaulic FireLock Automatic Sprinklers Installation and Maintenance Sheet for the product you are installing. This installation sheet is included with each shipment of Victaulic products for complete installation and assembly data, and is available in PDF format on our website at victaulic.com.

Warranty

Refer to the Warranty section of the current Price List or contact Victaulic for details.

Note

This product shall be manufactured by Victaulic or to Victaulic specifications. All products to be installed in accordance with current Victaulic installation/assembly instructions. Victaulic reserves the right to change product specifications, designs and standard equipment without notice and without incurring obligations.

Trademarks

Victaulic is a registered trademark of Victaulic Company.