

# M29

- 2 membrane semidrauliche, collettori interni, parti a contatto coi liquidi ossidate anticorrosione, comando incorporato o a distanza.
- 2 diaphragms semi-hydraulic, internal manifolds, all parts in contact with liquids are anodized anti-corrosion, control assembly incorporated or remote.
- 2 membranas semihidráulicas, colectores internos, partes en contacto con líquidos anodizadas anticorrosión, mando incorporado o a distancia.
- 2 membranes semi-hydrauliques, clavatures dans le carter, parties en contact avec le liquide anodisées, groupe de commande incorporé ou à distance.
- Boxerpumpe mit 2 Kolben-Membranen halb-hydraulisch gestützt. Integrierte Saug-Druckkanäle, Kontrollventil angeflanscht oder Fernbedienung. Flüssigkeitsführende Teile rostbeständig anodisiert.

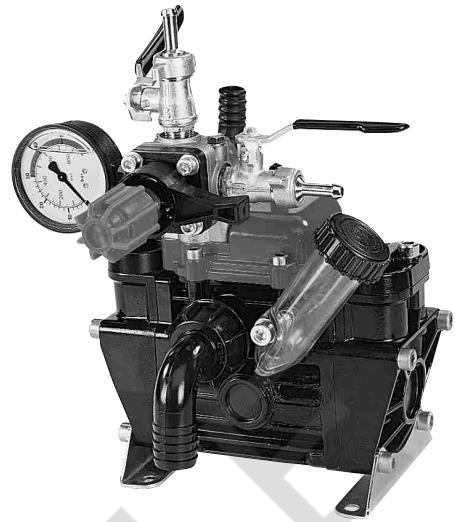

## IMPIEGHI

Irrorazione, disinfestazione.

## APPLICATIONS

Spraying, disinfecting.

## APLICACIONES

Pulverización, desinfección.

## EMPLOIS

Pulvérisation, désinfection.

## VERWENDUNGEN

Spritzen, Entwesung.

COMPONENTI	MATERIALI	COMPONENTS	MATERIALS	COMPONENTES	MATERIALES	COMPOSANTS	MATERIAUX	TEILE	MATERIALEN
carter	^ alluminio anodizzato	pump body	^ anodized aluminium	cuerpo bomba	^ aluminio anodizado	carter	^ aluminium anodisé	Gehäuse	^ anodiert Aluminium
testata	^ alluminio anodizzato	pump head	^ anodized aluminium	culata	^ aluminio anodizado	culasse	^ aluminium anodisé	Zylinderkopf	^ anodiert Aluminium
collettori	^ alluminio anodizzato	manifolds	^ anodized aluminium	colectores	^ aluminio anodizado	clavatures	^ aluminium anodisé	Saug-Druckkanälen	^ anodiert Aluminium
valvola a.-m.	acciaio inox	check valve	stainless steel	válvula a.-m.	acero inox	clapet asp. ref.	acier inox	Ventil	rostfreier Stahl
cappellotto valvola	resina sintetica	valve cage	synthetic resin	cajera válvula	resina sintética	cage du clapet	resine synthétique	Ventilkäfig	Kunstharz
membrana	* gomma nitrilica	pump diaphragm	* nitril rubber	membrana	* goma nitrilica	membrane	* caoutchouc nitrilique	Membrane	* Gummi
camera aria	gomma nitrilica	dumper diaphragm	nitril rubber	membrana calderin	goma nitrilica	chambre à air	caoutchouc nitrilique	Windkessel-membrane	Gummi
albero	acciaio cement. e temperato	pump shaft	casehardened steel	cigüeñal	acero cement. y templado	vilebrequin	acier cementé et trempé	Kurbelwelle	gehärteter Stahl

\* OPTIONAL DESMOPAN

\* OPTIONAL DESMOPAN

\* OPTIONAL DESMOPAN

\* OPTIONAL DESMOPAN

\* OPTIONAL DESMOPAN

^ OPTIONAL CATAFORESI

^ OPTIONAL CATAPHORESIS

^ OPTIONAL CATAFORESI

^ OPTIONAL CATAPHORÉSE

^ OPTIONAL KATAPHORESE

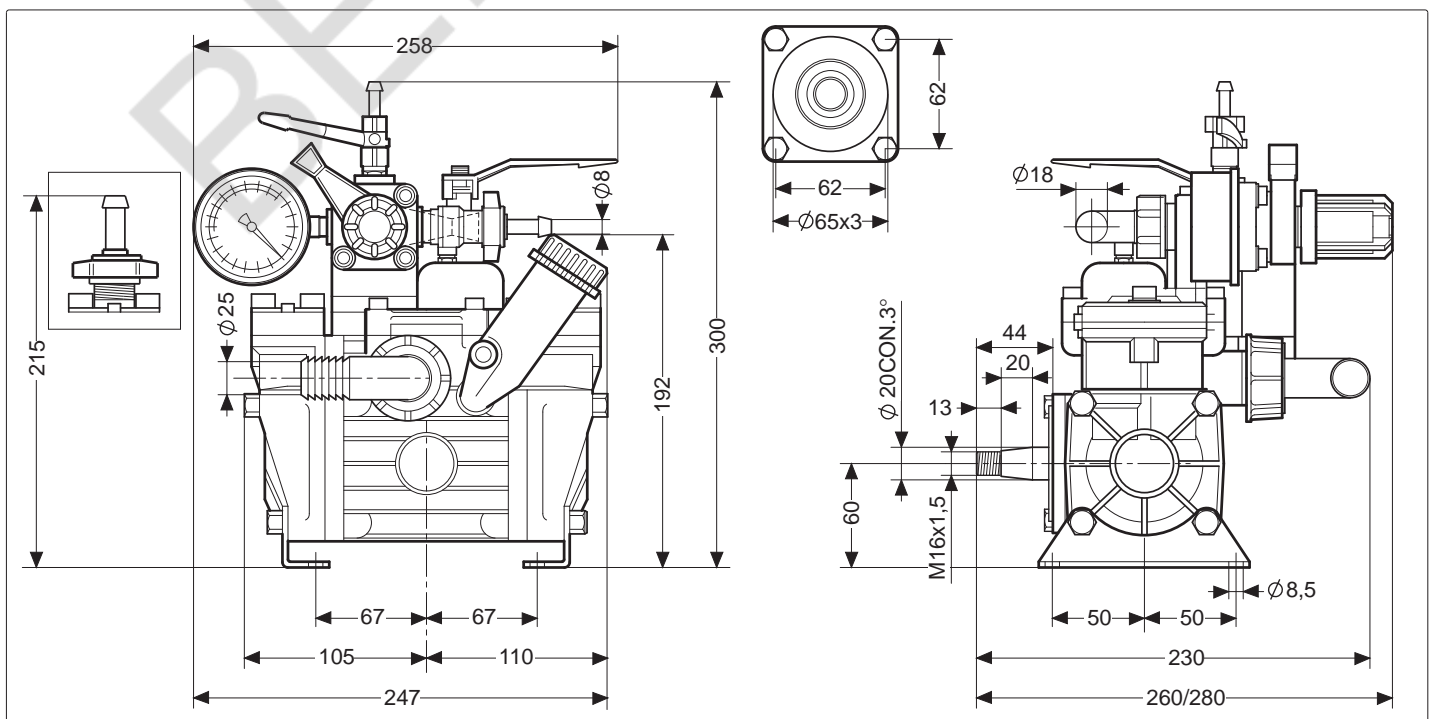

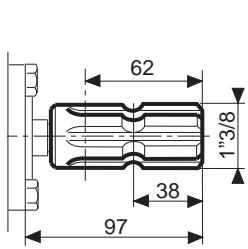

Cardano maschio 1"3/8  
1"3/8 P.T.O. male  
Cigüeñal estriado macho 1"3/8  
Cardan male 1"3/8  
Kardanzapfen 1"3/8 M.

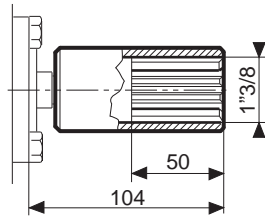

Cardano femmina 1"3/8  
1"3/8 P.T.O. female  
Cigüeñal estriado hembra 1"3/8  
Cardan femelle 1"3/8  
Kardan 1"3/8 F.

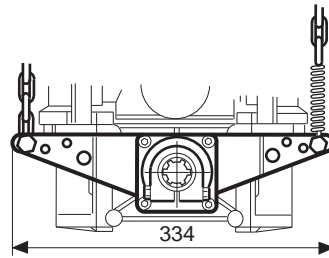

Attacco rapido 1"3/8 F.  
Quick coupler 1"3/8 F.  
Enganche 3 puntos toma de fuerza H. 1"3/8  
Prise rapide 1"3/8 F.  
3-Punkt Schnellanschluß 1"3/8 mit Ketten

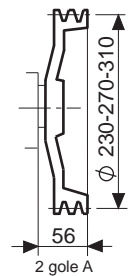
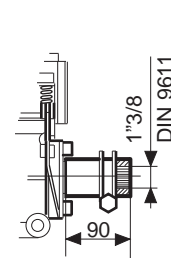

Puleggia  
Pulley  
Polea  
Poulie  
Keilriemenscheibe

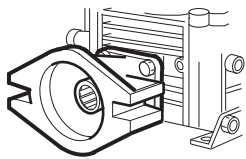

Flangiatura diretta  
Direct flange  
Brida directa  
Bridage direct  
Direkter Kupplungsflansch

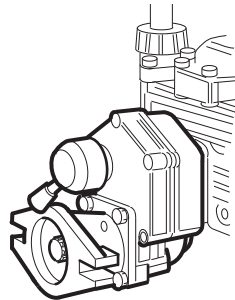

Flangiatura con riduttore e disinnesto  
Flange with red. gear and disconnect  
Brida con reductora y desembrague  
Bride avec réducteur et débrayage  
Flansch mit Untersetzungsgetriebe und Ausrückvorrichtung

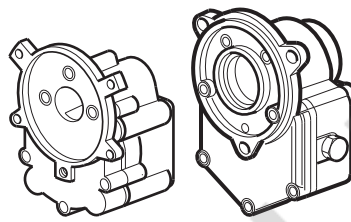

Riduttore per accoppiamento monoblocco  
Gearbox for close coupling  
Reductora directa  
Réducteur monobloc  
Untersetzungsgetriebe für Blockkupplung

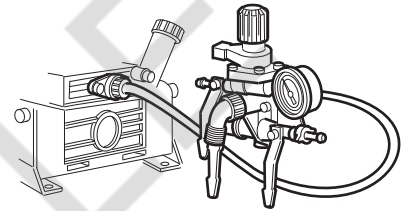

Comando a distanza  
Remote control  
Mando a distancia  
Commande à distance  
Fernbedienung

## VERSIONI

Albero conico ø 20 mm, motopompe.

Giri/1': max 700  
Pressione: max 30 BAR  
Portata: max 29 lt/1'  
Peso: kg 5,7  
Max. disl. asp.: mt 3

Max RPM: 700  
Pressure: max 30 BAR  
Capacity: max 29 lt/1'  
Weight: kg 5,7  
Max suction lift: mt 3

RPM max: 700  
Presión: max 30 BAR  
Caudal: max 29 lt/1'  
Peso: kg 5,7  
Max disn. asp.: mt 3

Tours/1' max: 700  
Pression: max 30 BAR  
Débit: max 29 lt/1'  
Poids: kg 5,7  
Max haut, asp.: mt 3

Umdr. pro Minute: max 700  
Druck: max 30 BAR  
Förderstrom: max 29 lt/1'  
Gewicht: kg 5,7  
Max Ansaughöhe: mt 3

## VERSIONS

Tapered shaft ø 20 mm, pump sets.

## VERSIONES

Eje cónico ø 20 mm, motobombas.

## VERSIONS

Arbre conique ø 20 mm, motopompes.

## AUSFÜHRUNGEN

Konische Welle ø 20 mm, Motorpumpen.

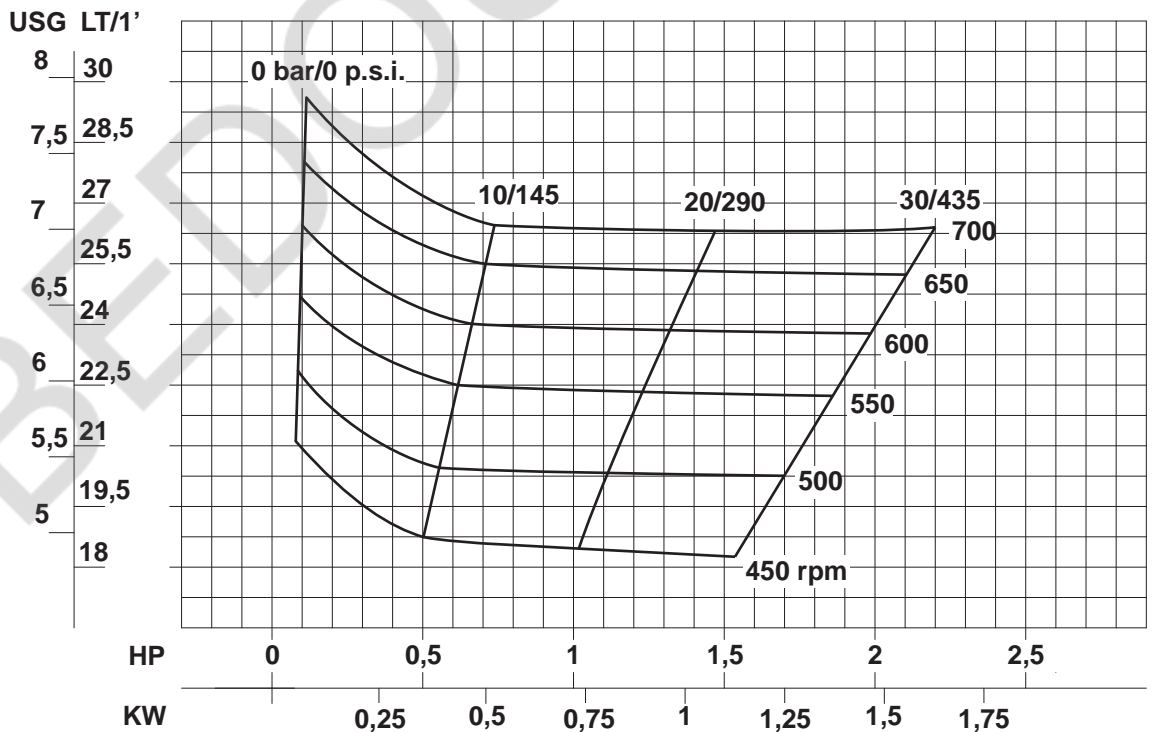

DATI INFORMATIVI

INDICATIVE DATA

DATOS INDICATIVOS

DONNÉES À TITRE D'INFORMATION

KENNDATEN UNVERBINDLICH

