

# B2N85H-Q20L60-2LU3-H1151/S97

## Inclinometer – With extended temperature range

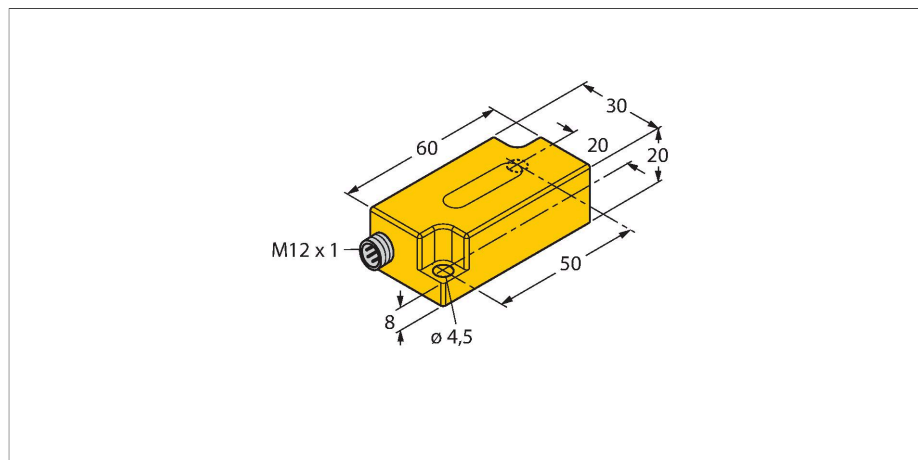

### Features

- Plastic, PC
- Zero point calibration +/- 15°
- Two analog outputs
- M12 x 1 male connector

### Wiring diagram

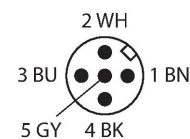
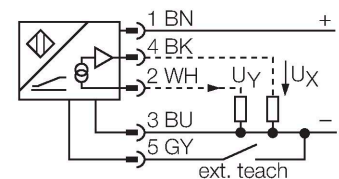

### Technical data

<b>Type</b>	B2N85H-Q20L60-2LU3-H1151/S97
Ident. no.	1534050
Measuring range	-85...85 °
Measuring range x-axis	-85...85 °
Measuring range y-axis	-85...85 °
Number of measuring axes	2
Repeatability	≤ 0.2 % of measuring range  A - B
Linearity deviation	≤ 1 %
Temperature drift	≤ ± 0.02 % / K
	for temperature range between -40 °C and +85 °C
Resolution	≤ 0.14 °
Ambient temperature	-40...+70 °C
Operating voltage	10...30 VDC
Isolation test voltage	≤ 0.5 kV
Short-circuit protection	yes
Wire breakage/Reverse polarity protection	no / yes
Surge protection	-48...48 VDC [U <sub>b,max.</sub> ]
Output function	5-pin, Analog output
Voltage output	0.1...4.9 V
Load resistance voltage output	≥ 40 kΩ
Response time	0.1 s
	time for the output signal to achieve 90% of full scale if the angle changes from -85° to +85°
Current consumption	50 mA
<b>Design</b>	Rectangular, Q20L60
Dimensions	60 x 30 x 20 mm

### Functional principle

Inclination is determined by a wear-free semiconducting sensor element.

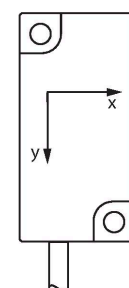
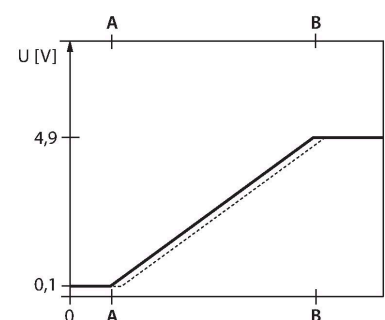
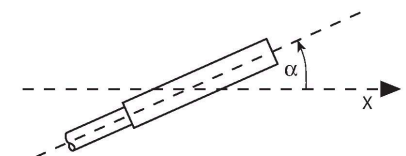

## Technical data

Housing material	Plastic, PC
Electrical connection	Connectors, M12 x 1
Vibration resistance	55 Hz (1 mm)
Shock resistance	30 g (11 ms)
Protection class	IP68 / IP69K
MTTF	203 years

## Mounting instructions

### Mounting instructions/Description

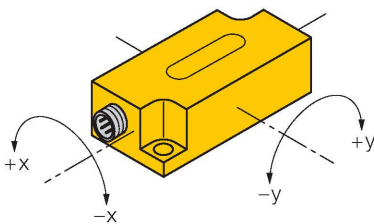

### Teaching

The zero point can be adjusted with teach adapter TX1-Q20L60. Teach-GND is pressed for approx. 1 s to do this. The outputs are switched to 5 V as confirmation. Teach-GND is pressed for 6 s to reset the axis zero points. The outputs are switched to 0 V as confirmation. Once the teach button is released, the sensor returns to normal operation.

## Accessories

### SG-Q20L60

6901100

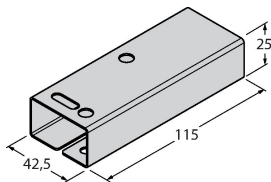

Protective housing for Q20L60 inclinometers for protecting against mechanical impact; material: Stainless steel

## Accessories

Dimension drawing	Type	Ident. no.	
	TX1-Q20L60	6967114	Teach adapter for inductive encoders, linear position, angle, ultrasonic and capacitive sensors