



inserts:		page
CD	40 poles + ⊕	43
CT, CTS (10A)	40 poles + ⊕	50
CDD	72 poles + ⊕	56
CQE	32 poles + ⊕	76
CN	16 poles + ⊕	82
CCE	16 poles + ⊕	90
CNE, CSE.....	16 poles + ⊕	91
CSS	16 poles + ⊕	100
CTE, CTSE (16A)....	16 poles + ⊕	108
CMSE	6+2 (aux) poles + ⊕	116
CMCE	6+2 (aux) poles + ⊕	116
CP.....	6 poles + ⊕	127
CX	6/36 and 12/2 poles + ⊕	130÷131
CX	4/0 and 4/2 poles + ⊕	132
MIXO	4 modules	137÷151

insert centre distance: 77.5 x 27 mm

bulkhead mounting housings with 2 levers or 4 pegs



bulkhead mounting housings with single lever



description	part No.	part No.
with one or two levers	CHI 16	CHI 16 L
with pegs ¹⁾	CHI 16 C	
with pegs and aluminium cover ¹⁾	CHI 16 CS	
with pegs and plastic cover ¹⁾	CHI 16 CP	
with lever and cover		CHI 16 LS

¹⁾ May be combined with hoods:
 - CHO/CAO 16 X and CHV/CAV 16 X
 - MHO/MAO 16 X and MHV/MAV 16 X

N.B.: the enclosures ensure IP66 protection (or IP65 cover versions) rating when mated and locked with the closing levers.
 The cover (CS, CP) only ensures mechanical protection, but does not ensure IP65 protection rating.

panel cut-out for bulkhead mounting housings in mm

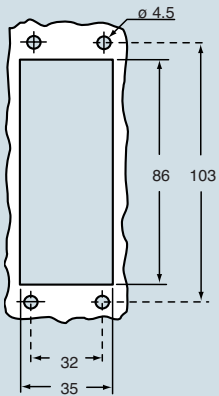

dimensions in mm

CHI

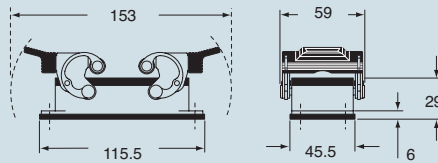

CHI C

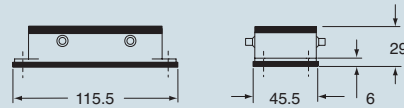

CHI CS/CP

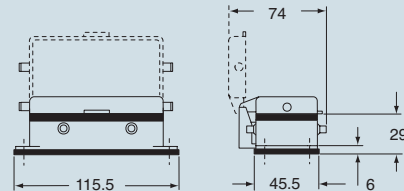

dimensions in mm

CHI L

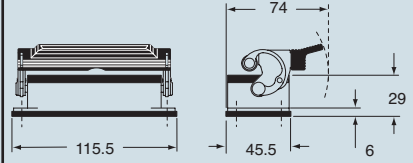

CHI LS

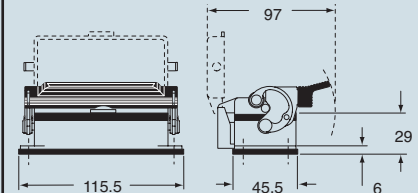

CAVUS® Type 4/4X/12
 (excluding enclosures with plastic cover)

dimensions indicated are not binding and may be changed without notice

size 77.27



inserts:		page
CD	40 poles + ⊕	43
CDD	72 poles + ⊕	56
CQE	32 poles + ⊕	76
CN	16 poles + ⊕	82
CCE	16 poles + ⊕	90
CNE, CSE	16 poles + ⊕	91
CSS	16 poles + ⊕	100
CMSE	6+2 (aux) poles + ⊕	116
CMCE	6+2 (aux) poles + ⊕	116
CP	6 poles + ⊕	127
CX	6/36 and 12/2 poles + ⊕	130÷131
CX	4/0 and 4/2 poles + ⊕	132
MIXO	4 modules	137÷151

insert centre distance: 77.5 x 27 mm

surface mounting housings with 2 levers or 4 pegs



surface mounting housings with single lever



description	part No.		part No.		part No.		part No.	
		entry Pg		entry M		entry Pg		entry M
with levers	CHP 16	21	MHP 16.25	25	CHP 16 L	21	MHP 16 L25	25
with levers	CHP 16.2	21 x 2	MHP 16.225	25 x 2	CHP 16 L2	21 x 2	MHP 16 L225	25 x 2
with levers, high construction	CAP 16.21	21	MAP 16.32	32	CAP 16 L	21	MAP 16 L32	32
with levers, high construction	CAP 16.221	21 x 2	MAP 16.232	32 x 2	CAP 16 L2	21 x 2	MAP 16 L232	32 x 2
with levers, high construction	CAP 16.29	29	MAP 16.40	40	CAP 16 L29	29	MAP 16 L40	40
with levers, high construction	CAP 16.229	29 x 2	MAP 16.240	40 x 2	CAP 16 L229	29 x 2	MAP 16 L240	40 x 2
with pegs and aluminium cover ¹⁾	CHP 16 CS	21	MHP 16 CS25	25				
with pegs and aluminium cover ¹⁾	CHP 16 CS2	21 x 2	MHP 16 CS225	25 x 2				
with pegs and aluminium cover, high construction ¹⁾	CAP 16 CS	21	MAP 16 CS32	32				
with pegs and aluminium cover, high construction ¹⁾	CAP 16 CS2	21 x 2	MAP 16 CS232	32 x 2				
with pegs and aluminium cover, high construction ¹⁾	CAP 16 CS29	29	MAP 16 CS40	40				
with pegs and aluminium cover, high construction ¹⁾	CAP 16 CS229	29 x 2	MAP 16 CS240	40 x 2				
with pegs and plastic cover ¹⁾	CHP 16 CP	21	MHP 16 CP25	25				
with pegs and plastic cover ¹⁾	CHP 16 CP2	21 x 2	MHP 16 CP225	25 x 2				
with pegs and plastic cover, high construction ¹⁾	CAP 16 CP	21	MAP 16 CP32	32				
with pegs and plastic cover, high construction ¹⁾	CAP 16 CP2	21 x 2	MAP 16 CP232	32 x 2				
with pegs and plastic cover, high construction ¹⁾	CAP 16 CP29	29	MAP 16 CP40	40				
with pegs and plastic cover, high construction ¹⁾	CAP 16 CP229	29 x 2	MAP 16 CP240	40 x 2				
with lever and cover					CHP 16 LS	21	MHP 16 LS25	25
with lever and cover					CHP 16 LS2	21 x 2	MHP 16 LS225	25 x 2
with lever and cover, high construction					CAP 16 LS	21	MAP 16 LS32	32
with lever and cover, high construction					CAP 16 LS2	21 x 2	MAP 16 LS232	32 x 2
with lever and cover, high construction					CAP 16 LS29	29	MAP 16 LS40	40
with lever and cover, high construction					CAP 16 LS229	29 x 2	MAP 16 LS240	40 x 2

¹⁾ May be combined with hoods:
- CHO/CAO 16 X and CHV/CAV 16 X
- MHO/MAO 16 X and MHV/MAV 16 X

N.B.: the enclosures ensure IP66 protection (or IP65 cover versions) rating when mated and locked with the closing levers.

The cover (CS, CP) only ensures mechanical protection, but does not ensure IP65 protection rating.

dimensions in mm

CHP - CAP and MHP - MAP

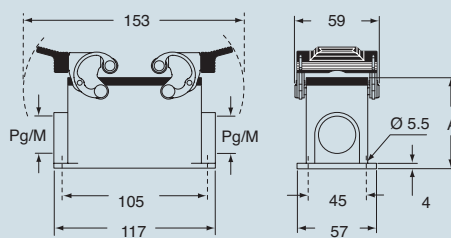

CHP CS/CP - CAP CS/CP and MHP CS/CP - MAP CS/CP

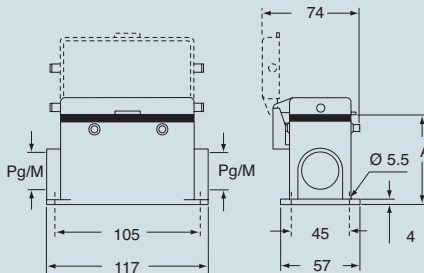

type	A
CHP / MHP	63
CAP / MAP	81
CHP CS / MHP CS	63
CAP CS / MAP CS	81
CHP CP / MHP CP	63
CAP CP / MAP CP	81

dimensions in mm

CHP L - CAP L and MHP L - MAP L

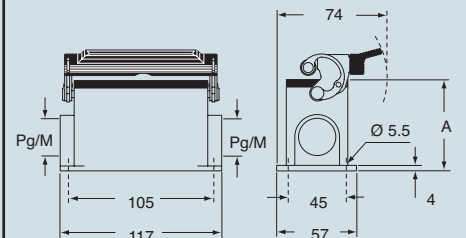

CHP LS - CAP LS and MHP LS - MAP LS

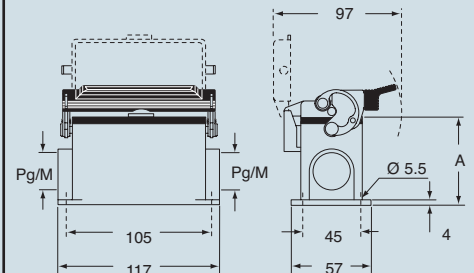

type	A
CHP L / MHP L	63
CAP L / MAP L	81
CHP LS / MHP LS	63
CAP LS / MAP LS	81

CAVUS® Type 4/4X/12

(excluding enclosures with plastic cover)

dimensions indicated are not binding and may be changed without notice

size 77.27



inserts:		page
CD	40 poles + ⊕	43
CDD	72 poles + ⊕	56
CQE	32 poles + ⊕	76
CN	16 poles + ⊕	82
CCE	16 poles + ⊕	90
CNE, CSE.....	16 poles + ⊕	91
CSS	16 poles + ⊕	100
CMSE	6+2 (aux) poles + ⊕	116
CMCE	6+2 (aux) poles + ⊕	116
CP.....	6 poles + ⊕	127
CX	6/36 and 12/2 poles + ⊕	130÷131
CX	4/0 and 4/2 poles + ⊕	132
MIXO	4 modules	137÷151

insert centre distance: 77.5 x 27 mm

hoods with 4 pegs



hoods with 2 pegs



description	part No.		part No.		part No.		part No.	
		entry Pg		entry M		entry Pg		entry M
with pegs, side entry	CHO 16	21	MHO 16.25	25	CHO 16 L	21	MHO 16 L25	25
with pegs, side entry			MHO 16.32	32			MHO 16 L32	32
with pegs, side entry, high construction	CAO 16.21	21	MAO 16.32	32	CAO 16 L21	21	MAO 16 L32	32
with pegs, side entry, high construction	CAO 16.29	29	MAO 16.40	40	CAO 16 L29	29	MAO 16 L40	40
with pegs, top entry	CHV 16	21	MHV 16.25	25	CHV 16 L	21	MHV 16 L25	25
with pegs, top entry			MHV 16.32	32			MHV 16 L32	32
with pegs, top entry, high construction	CAV 16.21	21	MAV 16.32	32	CAV 16 L21	21	MAV 16 L32	32
with pegs, top entry, high construction	CAV 16.29	29	MAV 16.40	40	CAV 16 L29	29	MAV 16 L40	40
with pegs, frontal entry, high construction	CAF 16	21	MAF 16.25	25				
with pegs, frontal entry, high constr., without adaptor *			MFF 16.25	25				

* enclosure without adaptor, threaded on the body, to be used only with a complete cable clamp.

** can only be used with a complete cable clamp (to be purchased separately)

dimensions in mm

CHO (CAO) and MHO (MAO)

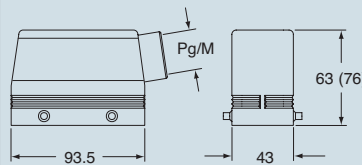

dimensions in mm

CHO L (CAO L) and MHO L (MAO L)

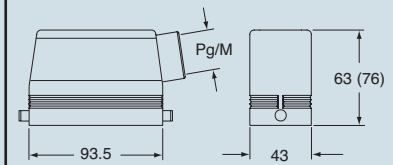

CHV (CAV) and MHV (MAV)

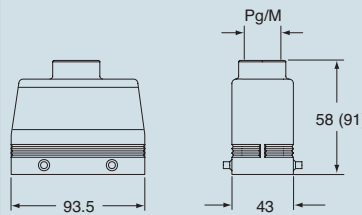

CHV L (CAV L) and MHV L (MAV L)

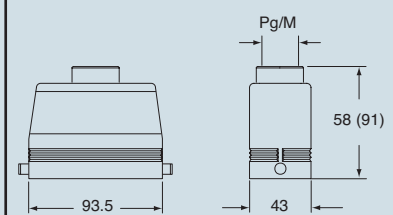

CAF/CFF and MAF/MFF

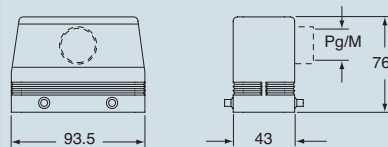

CALUS® Type 4/4X/12

dimensions indicated are not binding and may be changed without notice

size 77.27



inserts:		page
CD	40 poles + ⊕	43
CDD	72 poles + ⊕	56
CQE	32 poles + ⊕	76
CN	16 poles + ⊕	82
CCE	16 poles + ⊕	90
CNE, CSE	16 poles + ⊕	91
CSS	16 poles + ⊕	100
CMSE	6+2 (aux) poles + ⊕	116
CMCE	6+2 (aux) poles + ⊕	116
CP	6 poles + ⊕	127
CX	6/36 and 12/2 poles + ⊕	130÷131
CX	4/0 and 4/2 poles + ⊕	132
MIXO	4 modules	137÷151

insert centre distance: 77.5 x 27 mm

hoods with 2 levers



hoods with single lever



description	part No.		entry Pg		part No.		entry M	
with levers and gasket, top entry	CHV 16 G	21	MHV 16 G32	32	CHV 16 LG	21	MHV 16 LG32	32
with levers and gasket, top entry, high construction	CAV 16 G	21	MAV 16 G25	25	CAV 16 LG21	21	MAV 16 LG25	25
with levers and gasket, top entry, high construction	CAV 16 G29	29	MAV 16 G32	32	CAV 16 LG29	29	MAV 16 LG32	32
with levers and gasket, top entry, high constr., without adaptor *	CFV 16 G	21	MFV 16 G25	25	CFV 16 LG21	21	MFV 16 LG25	25
with levers and gasket, top entry, high constr., without adaptor *	CFV 16 G29	29	MFV 16 G32	32	CFV 16 LG29	29	MFV 16 LG32	32

* enclosure without adaptor, threaded on the body, to be used only with a complete cable clamp.

dimensions in mm

CHV G (CAV G) and [CFV G],
MHV G (MAV G) and [MFV G]

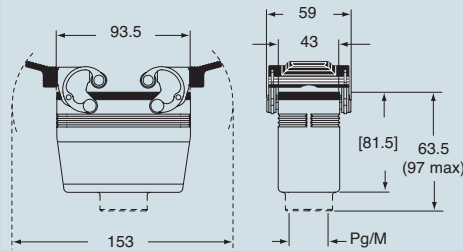

dimensions in mm

CHV LG (CAV LG) and [CFV LG],
MHV LG (MAV LG) and [MFV LG]

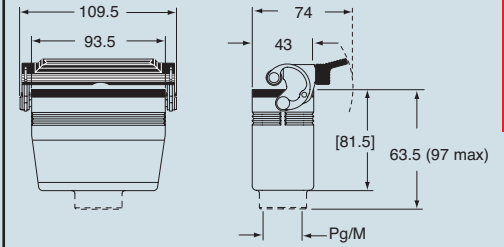

CALUS® Type 4/4X/12

dimensions indicated are not binding and may be changed without notice

size 77.27

inserts:		page
CD	40 poles + ⊕	43
CDD	72 poles + ⊕	56
CQE	32 poles + ⊕	76
CN	16 poles + ⊕	82
CCE	16 poles + ⊕	90
CNE, CSE.....	16 poles + ⊕	91
CSS	16 poles + ⊕	100
CMSE	6+2 (aux) poles + ⊕	116
CMCE	6+2 (aux) poles + ⊕	116
CP	6 poles + ⊕	127
CX	6/36 and 12/2 poles + ⊕	130÷131
CX	4/0 and 4/2 poles + ⊕	132
MIXO	4 modules	137÷151

insert centre distance:
77.5 x 27 mm

hoods with 2 levers



covers

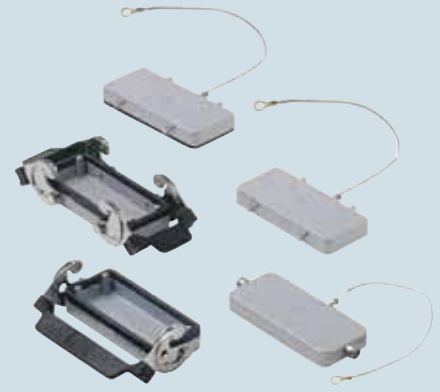

description	part No.	entry Pg	part No.	entry M	part No.
with levers, side entry ¹⁾	CHO 16 X	21	MHO 16 X25	25	
with levers, side entry ¹⁾			MHO 16 X32	32	
with levers, side entry, high construction ¹⁾	CAO 16 X	21	MAO 16 X32	32	
with levers, side entry, high construction ¹⁾	CAO 16 X29	29	MAO 16 X40	40	
with levers, top entry ¹⁾	CHV 16 X	21	MHV 16 X25	25	
with levers, top entry ¹⁾			MHV 16 X32	32	
with levers, top entry, high construction ¹⁾	CAV 16 X	21	MAV 16 X32	32	
with levers, top entry, high construction ¹⁾	CAV 16 X29	29	MAV 16 X40	40	
with 4 pegs (for housings with 2 levers with gasket)					CHC 16
with 4 pegs and gasket (for housings with 2 levers) ²⁾					CHC 16 C
with 2 pegs (for housings with 1 lever with gasket)					CHC 16 L
with 2 levers (for hoods with 4 pegs)					CHC 16 G
with 1 lever (for hoods with 2 pegs)					CHC 16 LG

¹⁾ May be combined with housings:
- CHI/CHP/CAP 16 CS/CP/C
- MHP/MAP 16 CS/CP

²⁾ May be combined with housings:
- CHO/CAO 16 X and CHV/CAV 16 X
- MHO/MAO 16 X and MHV/MAV 16 X

The covers for C, G and LG, versions cannot be used together with coding pins. If this application is required, please contact ILME SpA.

dimensions in mm

CHO X (CAO X) and MHO X (MAO X)

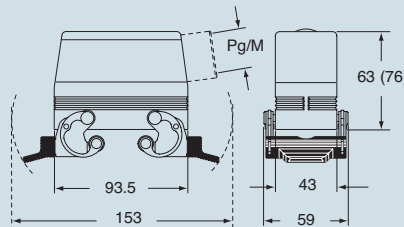

CHV X (CAV X) and MHV X (MAV X)

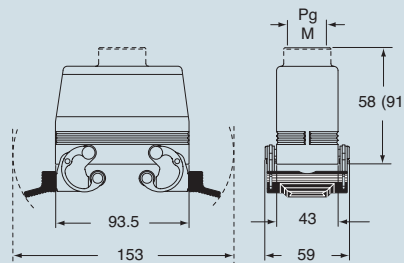

dimensions in mm

CHC



CHC C



CHC L



CHC G

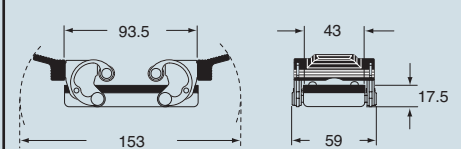

CHC LG

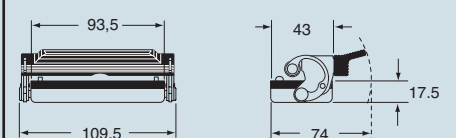

CAUS® Type 4/4X/12

dimensions indicated are not binding and may be changed without notice

size 77.27



inserts:		page
CN RY	16 poles + ⊕	82
CNE RY	16 poles + ⊕	91
CP RY	6 poles + ⊕	127

insert centre distance:
77.5 x 27 mm

The covers for G versions cannot be used together with coding pins. If this application is required, please contact ILME SpA.

housings and cover

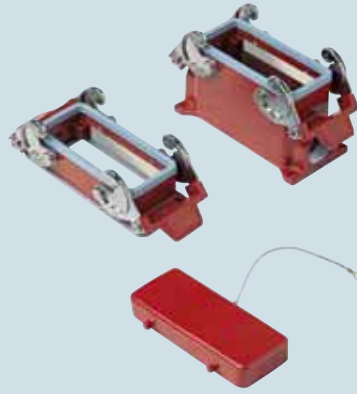

hoods and cover



description	part No.		part No.		part No.		part No.	
		entry Pg		entry M		entry Pg		entry M
bulkhead mounting, with levers	CHIR 16	---						
surface mounting, with levers, high construction	CAPR 16.21	21	MAPR 16.32	32				
cover with 4 pegs (for housings)	CHCR 16							
with pegs, side entry					CHOR 16	21	MHOR 16.25	25
with pegs, side entry, high construction					CAOR 16.21	21	MAOR 16.40	40
with pegs, top entry					CHVR 16	21	MHVR 16.25	25
with pegs, top entry, high construction					CAVR 16.21	21	MAVR 16.40	40
cover with 2 levers (for hoods)					CHCR 16 G			

panel cut-out for bulkhead mounting housings in mm

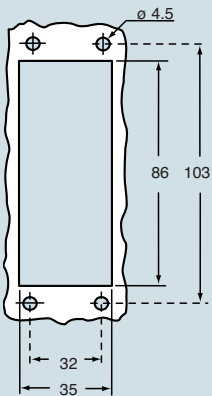

dimensions in mm

CHIR

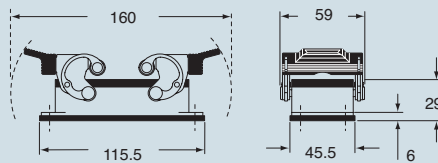

CAPR and MAPR

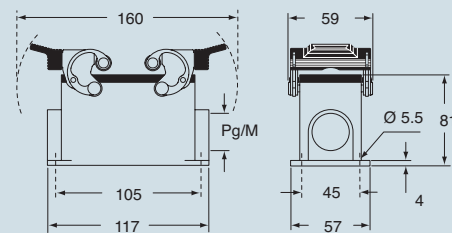

CHCR



dimensions in mm

CHOR (CAOR) and MHOR (MAOR)

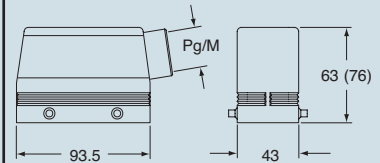

CHVR (CAVR) and MHVR (MAVR)

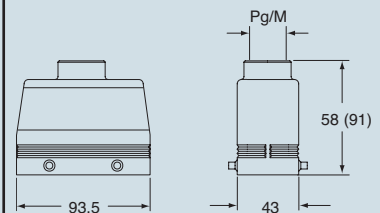

CHCR G

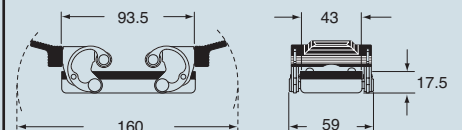

ILME® Type 4/4X/12

dimensions indicated are not binding and may be changed without notice

size 77.27



inserts:		page
CD	40 poles + ⊕	43
CT, CTS *) (10A)	40 poles + ⊕	50
CDD	72 poles + ⊕	56
CQE	32 poles + ⊕	76
CN	16 poles + ⊕	82
CCE	16 poles + ⊕	90
CNE, CSE.....	16 poles + ⊕	91
CSS	16 poles + ⊕	100
CTE, CTSE *) (16A)	16 poles + ⊕	108
CMSE	6+2 (aux) poles + ⊕	116
CMCE	6+2 (aux) poles + ⊕	116
CME	6+2 (aux) poles + ⊕	117
CP	6 poles + ⊕	127
CX	6/36 and 12/2 poles + ⊕	130÷131
CX	4/0 and 4/2 poles + ⊕	132
MIXO	4 modules	137÷151

insert centre distance: 77.5 x 27 mm

*) only for enclosure CHIW 16

housings and cover



hoods and cover



description	part No.		entry		part No.		entry	
			Pg	M			Pg	M
bulkhead mounting, with levers	CHIW 16	---						
surface mounting, with levers, high construction	CAPW 16.21	21		MAPW 16.32	32			
cover with 4 pegs (for enclosures with 2 levers)	CHCW 16							
with pegs, side entry					CHOW 16	21	MHOW 16.25	25
with pegs, side entry, high construction					CAOW 16.29	29	MHOW 16.32	32
with pegs, side entry, high construction							MAOW 16.32	32
with pegs, top entry					CHVW 16	21	MHVW 16.25	25
with pegs, top entry, high construction					CAVW 16.29	29	MHVW 16.32	32
with pegs, top entry, high construction							MAVW 16.32	32
with pegs, top entry, high construction							MAVW 16.40	40
cover with 2 levers (for enclosures with 4 pegs)	CHCW 16 G							
with levers and gasket, top entry	CAVW 16 G29	29					MAVW 16 G32	32

panel cut-out for bulkhead mounting housings in mm

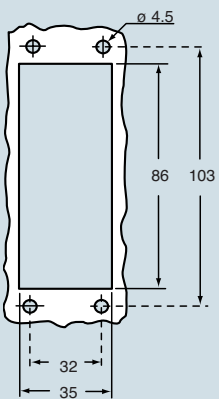

The covers for G versions cannot be used together with coding pins. If this application is required, please contact ILME SpA.

dimensions in mm

CHIW

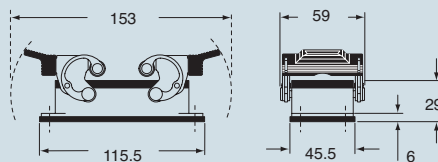

CAPW and MAPW

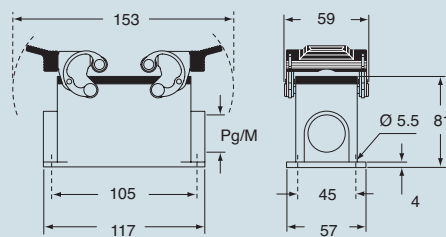

CHCW



dimensions in mm

CHOW (CAOW) and MHOW (MAOW)

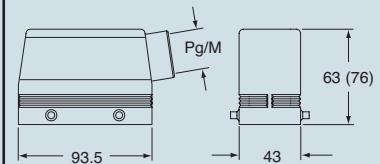

CHVW (CAVW) and MHVW (MAVW)

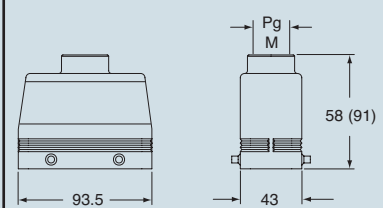

CHCW G

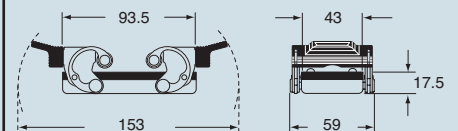

CAVW G and MAVW G

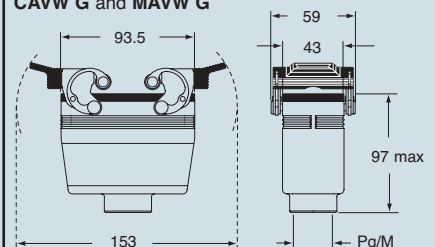

ILME® Type 4/4X/12

dimensions indicated are not binding and may be changed without notice

size 77.27



inserts:		page
CD	40 poles + ⊕	43
CT, CTS *) (10A)	40 poles + ⊕	50
CDD	72 poles + ⊕	56
CQE	32 poles + ⊕	76
CN	16 poles + ⊕	82
CCE	16 poles + ⊕	90
CNE, CSE	16 poles + ⊕	91
CSS	16 poles + ⊕	100
CTE, CTSE *) (16A)	16 poles + ⊕	108
CMSE	6+2 (aux) poles + ⊕	116
CMCE	6+2 (aux) poles + ⊕	116
CP	6 poles + ⊕	127
CX	6/36 and 12/2 poles + ⊕	130÷131
CX	4/0 and 4/2 poles + ⊕	132
MIXO	4 modules	137÷151

insert centre distance: 77.5 x 27 mm

*) only for enclosure CHIS 16

housings and cover for electromagnetic compatibility

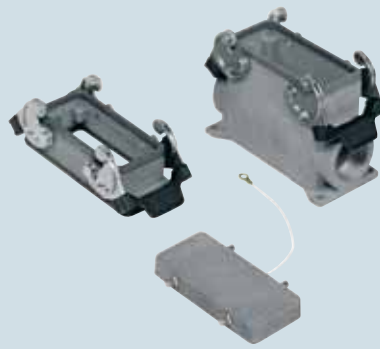

hoods and cover for electromagnetic compatibility



description	part No.		part No.		part No.		part No.	
	entry Pg	entry M	entry Pg	entry M	entry Pg	entry M	entry Pg	entry M
bulkhead mounting, with levers	CHIS 16	---						
surface mounting, with levers, high construction	CAPS 16.21	21	MAPS 16.32	32				
cover with 4 pegs (for enclosures with 2 levers)	CHCS 16							
with pegs, side entry					CHOS 16	21	MHOS 16.25	25
with pegs, side entry, high construction					CAOS 16.29	29	MHOS 16.32	32
with pegs, side entry, high construction							MAOS 16.32	32
with pegs, top entry					CHVS 16	21	MAOS 16.40	40
with pegs, top entry, high construction							MHVS 16.25	25
with pegs, top entry, high construction					CAVS 16.29	29	MHVS 16.32	32
with pegs, top entry, high construction							MAVS 16.32	32
with pegs, top entry, high construction							MAVS 16.40	40
cover with 2 levers (for enclosures with 4 pegs)					CHCS 16 G			

panel cut-out for bulkhead mounting housings in mm

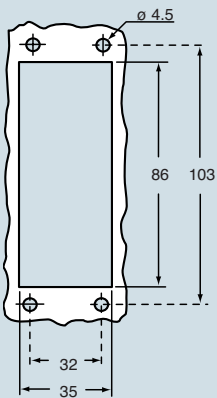

The covers for G versions cannot be used together with coding pins. If this application is required, please contact ILME SpA.

dimensions in mm

CHIS

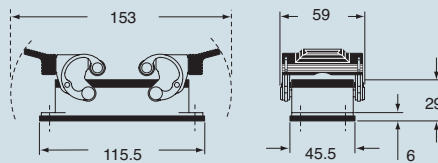

CAPS and MAPS

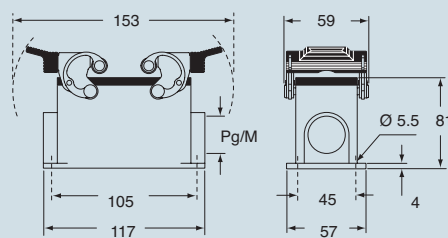

CHCS



dimensions in mm

CHOS (CAOS) and MHOS (MAOS)

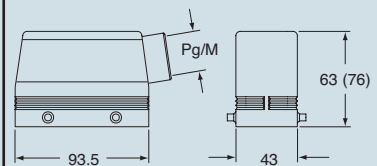

CHVS (CAVS) and MHVS (MAVS)

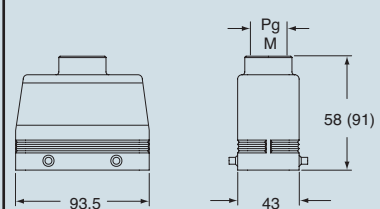

CHCS G

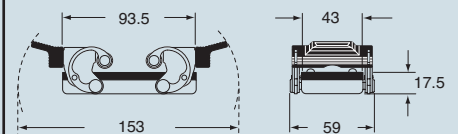

ILME® Type 4/4X/12

dimensions indicated are not binding and may be changed without notice

size 77.27